

USB HIGH-SIDE POWER SWITCH

NO.EA-168-180516

OUTLINE

The R5523N is a high-side MOSFET switch IC for Universal Serial Bus (USB) applications. Low ON Resistance (Typ.130mΩ) and low supply current (Typ.20μA at active mode) are realized in this IC. An over-current limit circuit, a thermal shutdown circuit, and an under voltage lockout (UVLO) circuit are built-in as protection circuits. Further, a delay circuit for flag signal after detecting over-current, is embedded to prevent miss-operation of error flag because of inrush current. The R5523N Series is ideal for applications of protection for USB power supply. Since the package is small SOT-23-5, high density mounting on board is possible.

FEATURES

- Built-in P-channel MOSFET Switch
- Supply CurrentTyp. 20μA (at Active Mode)
- Switch ON ResistanceTyp. 130mΩ
- Output Current.....Min. 500mA
- Flag Delay TimeTyp. 10ms.
- Package.....SOT-23-5
- Over- Current Limit / Short Circuit Protection
- Built-in Under Voltage Lockout (UVLO) Function
- Built-in Thermal Shutdown Protection
- Built-in Soft-start Function

APPLICATIONS

- USB Peripherals
- Notebook PCs

SELECTION GUIDE

The logic of the enable pin for the ICs can be selected at the user's request.

Product Name	Package	Quantity per Reel	Pb Free	Halogen Free
R5523N001*-TR-FE	SOT-23-5	3,000 pcs	Yes	Yes

* : Designation of the logic of the enable pin.
 (A) "L" active
 (B) "H" active

R5523N

NO.EA-168-180516

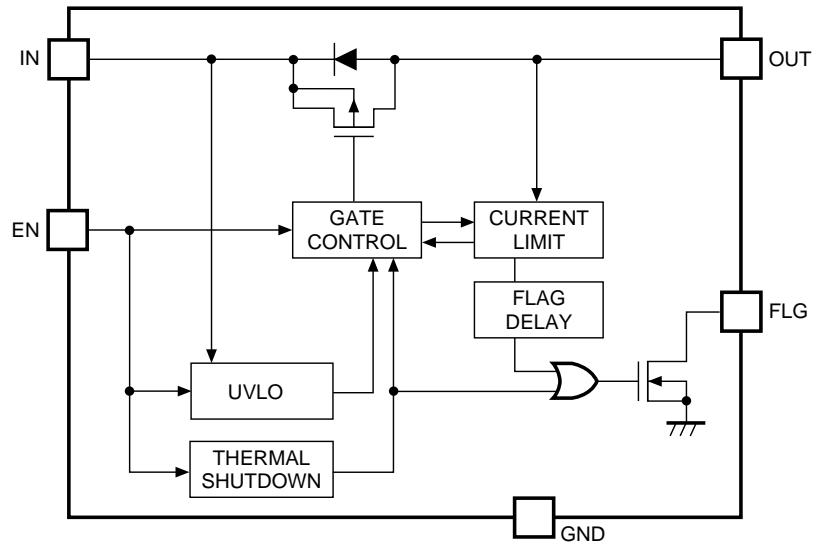
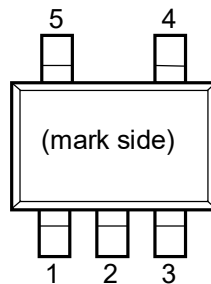
BLOCK DIAGRAM**R5523N Block Diagram****PIN DESCRIPTION****R5523N (SOT-23-5) Pin Configuration**

Pin No	Symbol	Pin Description
1	EN	Enable Pin
2	GND	Ground Pin
3	FLG	FLG pin (Open Drain Output)
4	VIN	Power Supply Pin
5	VOUT	Output Pin

NO.EA-168-180516

ABSOLUTE MAXIMUM RATINGS

Symbol	Item	Rating	Unit
V_{IN}	Input Voltage	6.5	V
V_{EN}	Enable Pin Input Voltage	-0.3 to $V_{IN}+0.3$	V
V_{FLG}	Flag Voltage	-0.3 to 6.5	V
I_{FLG}	Flag Current	14	mA
V_{OUT}	Output Voltage	-0.3 to $V_{IN}+0.3$	V
I_{OUT}	Output Current	Internal Limited	
P_D	Power Dissipation ⁽¹⁾ (SOT-23-5, JEDEC STD.51-7)	660	mW
T_j	Junction Temperature Range	-40 to 125	°C
T_{stg}	Storage Temperature	-55 to 125	°C

ABSOLUTE MAXIMUM RATINGS

Electronic and mechanical stress momentarily exceeded absolute maximum ratings may cause the permanent damages and may degrade the lifetime and safety for both device and system using the device in the field. The functional operation at or over these absolute maximum ratings is not assured.

RECOMMENDED OPERATING CONDITIONS

Symbol	Parameter	Rating	Unit
V_{IN}	Operating Input Voltage	2.2 to 5.5	V
T_a	Operating Temperature Range	-40 to 85	°C

RECOMMENDED OPERATING CONDITIONS

All of electronic equipment should be designed that the mounted semiconductor devices operate within the recommended operating conditions. The semiconductor devices cannot operate normally over the recommended operating conditions, even if when they are used over such conditions by momentary electronic noise or surge. And the semiconductor devices may receive serious damage when they continue to operate over the recommended operating conditions.

⁽²⁾ Refer to *POWER DISSIPATION* for detailed information.

R5523N

NO.EA-168-180516

ELECTRICAL CHARACTERISTICS

R5523N001A/B Electrical Characteristics

(Ta = 25°C)

Symbol	Item	Conditions	Min.	Typ.	Max.	Unit
I _{DD1}	Supply Current 1 (Enabled)	V _{OUT} = OPEN ⁽¹⁾		20	45	μA
I _{DD2}	Supply Current 2 (Disabled)	V _{OUT} = OPEN ⁽²⁾		0.1	1.0	μA
R _{ON}	Switch On Resistance	V _{IN} = 5V, I _{OUT} = 500mA		130	180	mΩ
t _{on}	Output Turn-on Delay	V _{IN} = 5V, R _L = 60Ω		1400		μs
t _{off}	Output Turn-off Delay	V _{IN} = 5V, R _L = 60Ω		5		μs
V _{UVLO}	UVLO Threshold	V _{IN} at increasing	1.6	1.9		V
V _{HYS}	UVLO Hysteresis Range	V _{IN} at decreasing		0.1		V
I _{TH}	Current Limit Threshold			1.0	1.5	A
I _{LIM}	Short Current Limit	V _{IN} =5V, 5ms after V _{OUT} = 0V ⁽³⁾	0.5	0.75	1.3	A
t _{FD}	Over Current Flag Delay	V _{IN} = 5V, From Over Current to FLG = "L"	5	10	20	ms
T _{TS}	Thermal Shutdown Temperature Threshold	T _j at increasing		135		°C
		T _j at decreasing		120		°C
I _{EN}	Enable Pin Input Current			0.01	1.0	μA
V _{EN1}	Enable Pin Input Voltage 1	V _{EN} at increasing	2.0			V
V _{EN2}	Enable Pin Input Voltage 2	V _{EN} at decreasing			0.8	V
I _{LO}	Output Leakage Current			0.1	1.0	μA
V _{LF}	Flag "L" Output Voltage	I _{SINK} = 1mA			0.4	V
I _{FOF}	Flag Off Current	V _{FLG} = 5.5V		0.01	1.0	μA

⁽¹⁾ EN="L"(R5523NxxxA), EN="H"(R5523NxxxB)

⁽²⁾ EN="H"(R5523NxxxA), EN="L"(R5523NxxxB)

⁽³⁾ Refer to "Overcurrent Detection and Overcurrent limit" in THEORY OF OPERATION for details.

NO.EA-168-180516

THEORY OF OPERATION

This explanation is based on the typical application.

- There is a parasitic diode between source and drain of the switch transistor. (Refer to the block diagram.) Because of this, in both cases of enable and disable, if the voltage of V_{OUT} pin is higher than V_{IN} pin, current flows from V_{OUT} to V_{IN} .
- In case that V_{OUT} pin and GND is short, if over-current would continue, the temperature of the IC would increase drastically. If the temperature of the IC is beyond 135°C , the switch transistor turns off and the FLG pin level becomes "L". Then, when the temperature of the IC decreases equal or lower than 120°C , the switch transistor turns on and FLG becomes "H". Unless the abnormal situation of V_{OUT} pin is removed, the switch transistor repeats on and off. Refer to the 24) Thermal Shutdown operation in the typical characteristics.
- Over-current level is set internally in the IC. There are three types of response against over-current: Under the condition that V_{OUT} pin is short or large capacity is loaded, if the IC is enabled, the IC becomes constant current state. After the flag delay time passes, FLG becomes "L", that means over current state. Refer to the 23) current limit transient response of typical characteristics. While the switch transistor is on, if V_{OUT} pin is short or large capacity is loaded, until the current limit circuit responds, large transient current flows. After the transient current is beyond the over-current detector threshold and delay time of the flag passes, FLG becomes "L", that means over current state. Refer to the 25), 26) over-current limit transient response of typical characteristics. In the case that load current gradually increases, the IC is not into the constant current state until the current is beyond over current limit. Once the level is beyond the over current detector threshold, load current is limited into over current limit level. Note that load current continuously flows until the load current is beyond the over-current detector threshold.
- FLG pin is Nch Open drain output. If the over-current or over-temperature is detected, FLG becomes "L". If over-current is detected, FLG becomes "L" after the flag delay time t_{FD} passes. Therefore flag signal is not out with inrush current.
- UVLO circuit prevents that the switch transistor turns on until the input voltage is beyond 1.9V. UVLO circuit can operate when the IC is enabled.

R5523N

NO.EA-168-180516

Timing Chart**R5523N001A**

Output On time/ Output Off time

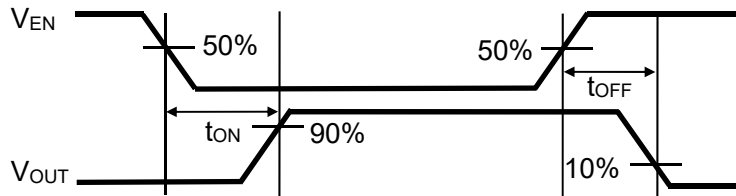

FLG Output Delay Time

**R5523N001B**

Output On time/ Output Off time

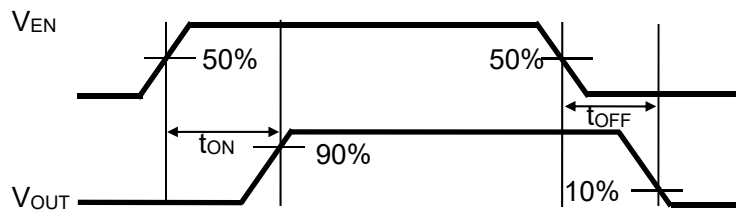

FLG Output Delay Time

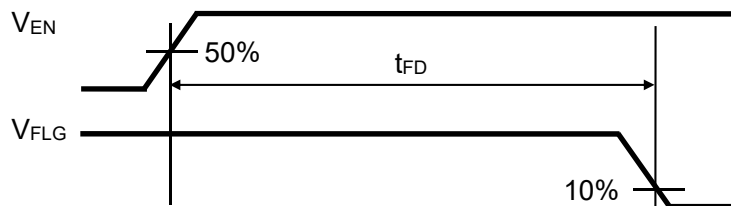

NO.EA-168-180516

Overcurrent Detection and Overcurrent Limit

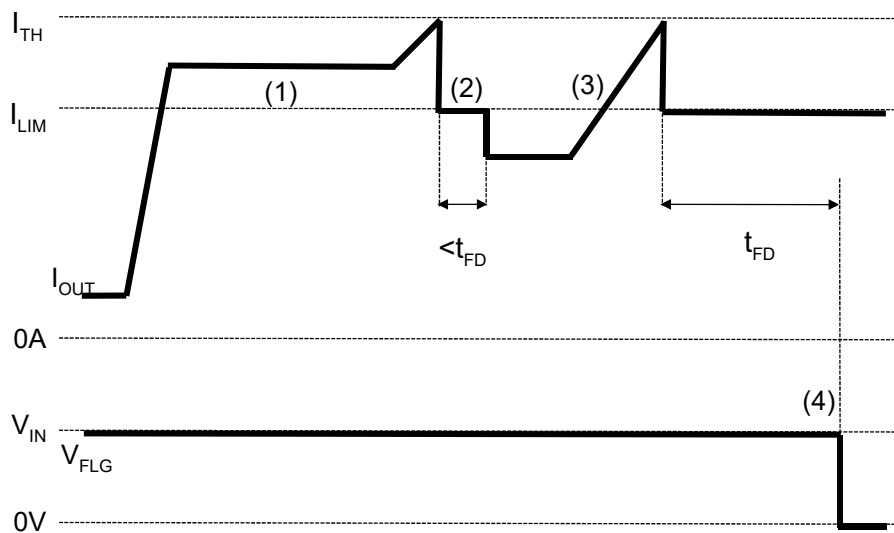

R5523N001A / R5523N001B Overcurrent Detection and Overcurrent limit Timing Chart

- (1) When the I_{OUT} is I_{TH} or less, the current is not limited.
- (2) Once the I_{OUT} reaches to I_{TH} , the I_{OUT} is limited by I_{LIM} .
- (3) When the I_{OUT} drops to I_{LIM} or less within the t_{FD} time, the current limit is released. The current is not limited until the I_{OUT} exceeds I_{TH} again.
- (4) When the I_{OUT} reaches to I_{TH} and it is limited by I_{LIM} for t_{FD} or more, the switch transistor turns off and V_{FLG} becomes "Low".

APPLICATION INFORMATION TECHNICAL NOTES

Typical Application Circuit

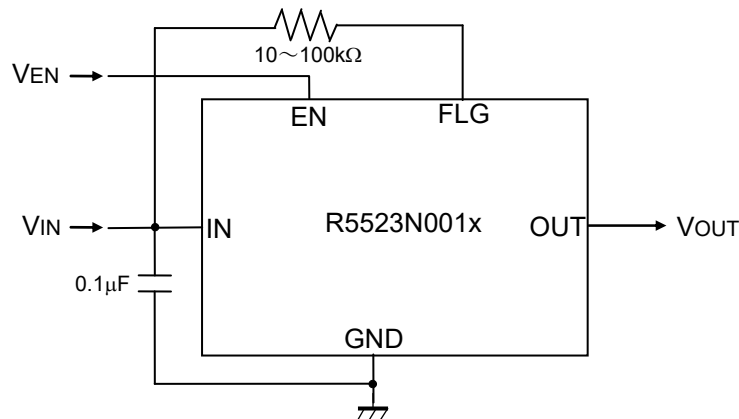

R5523N001x Typical Application Circuit

Precautions for Selecting External Components

- **Bypass capacitor**

Put a capacitance range from 0.1μF to 1μF bypass capacitor between VIN pin and GND pin of the IC. Without a bypass capacitor, in case of output short, because of the high side inductance of VIN pin, the ringing may be generated and it might be a cause of an unstable operation.

- **Pull-up resistance value range of flag pin**

Recommended pull-up resistance value range of flag pin is from 10kΩ to 100kΩ.

- **Over-current limit Function**

In case that VOUT pin and GND is short, if over-current would continue, the temperature of the IC would increase drastically. If the temperature of the IC is equal or more than 135°C (Typ.), the switch transistor turns off because of thermal shutdown protection. In other words, when the temperature of the IC becomes equal or more than 135°C (Typ.), both the over-current limit circuit and thermal shutdown circuit work for the protection of the IC.

NO.EA-168-180516

TYPICAL CHARACTERISTICS

Typical Characteristics are intended to be used as reference data, they are not guaranteed.

1) Output Voltage vs. Output Current

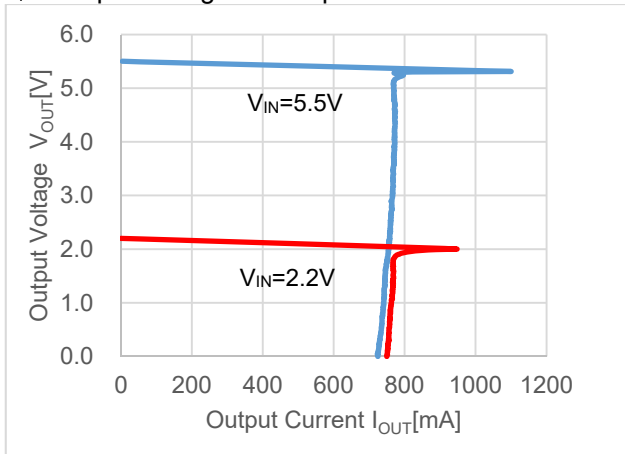

2) Supply Current vs. Temperature

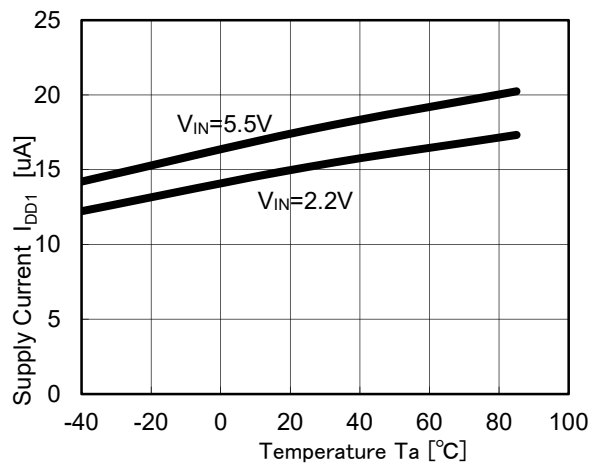

3) Supply Current vs. Input Voltage

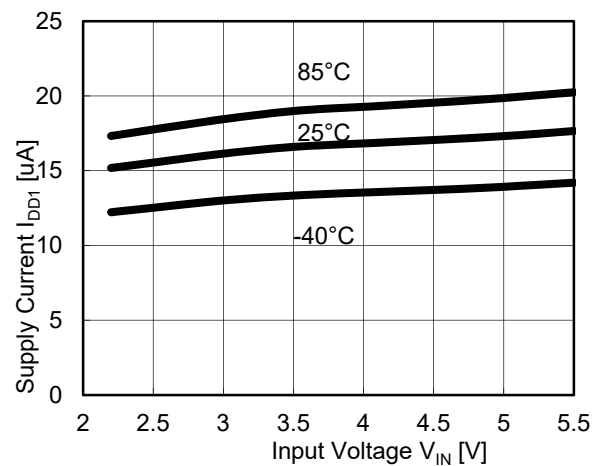

4) On Resistance vs. Temperature

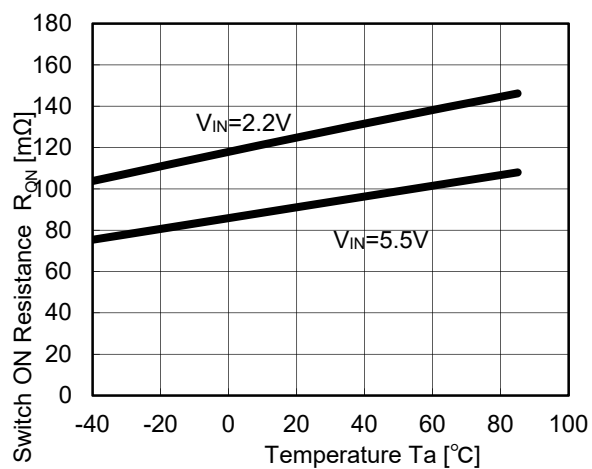

5) On Resistance vs. Input Voltage

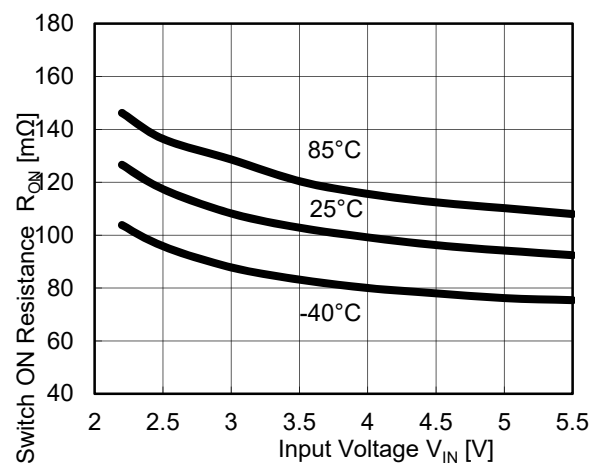

6) Output On Time vs. Temperature

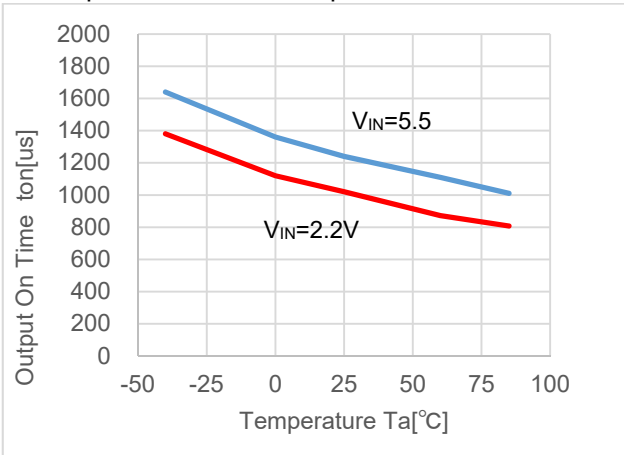

7) Output On Time vs. Input Voltage

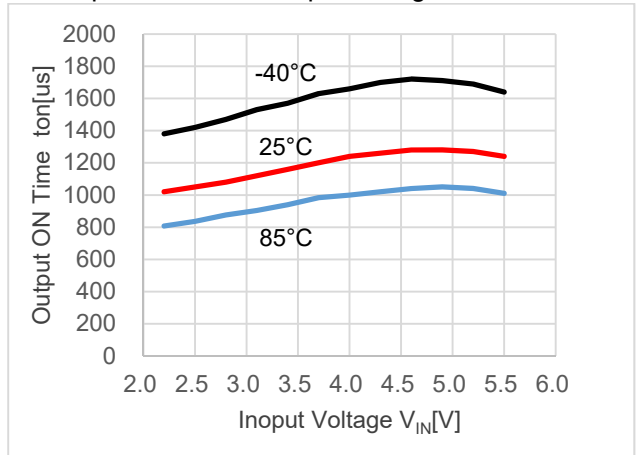

8) Output Off Time vs. Temperature

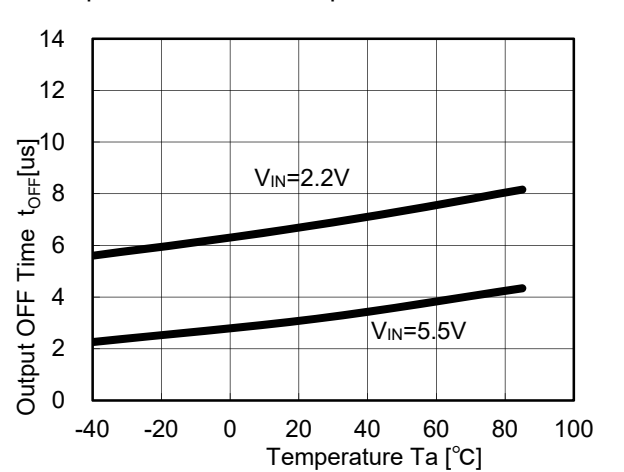

9) Output Off Time vs. Input Voltage

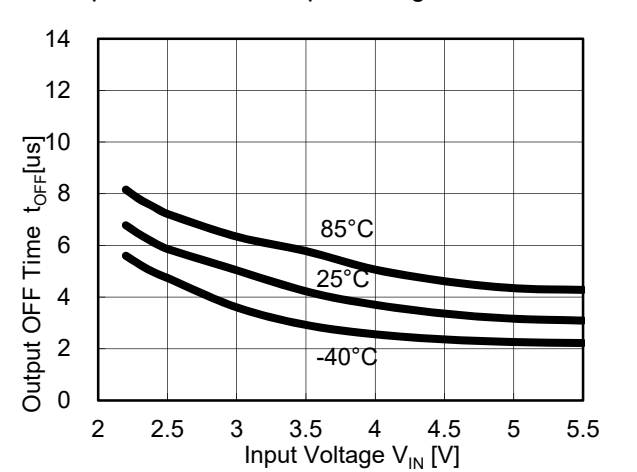

10) Overcurrent Threshold vs. Temperature

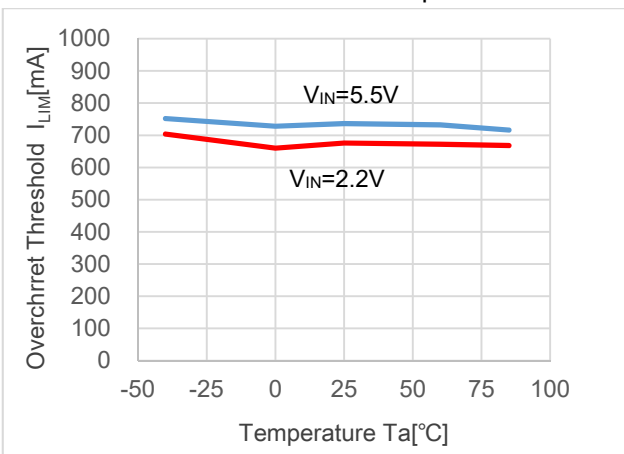

11) Overcurrent Threshold vs. Input Voltage

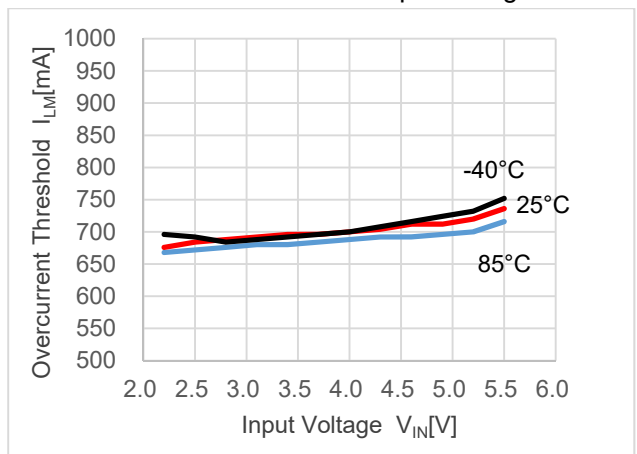

NO.EA-168-180516

12) Overcurrent Threshold vs. Temperature

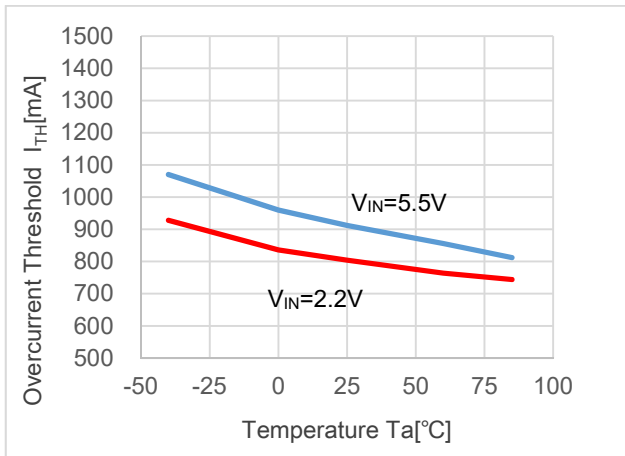

13) Overcurrent Threshold vs. Input Voltage

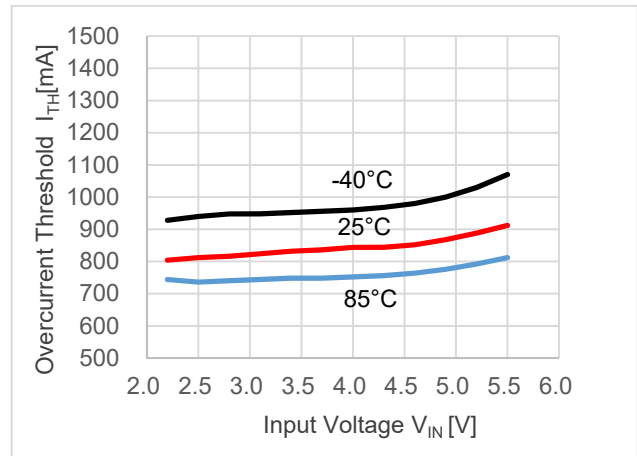

14) Enable Input Voltage vs. Temperature

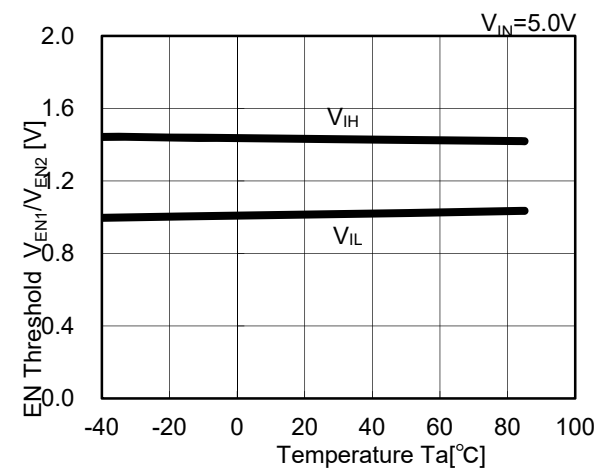

15) Enable Input Voltage vs. V_{IN} Input Voltage

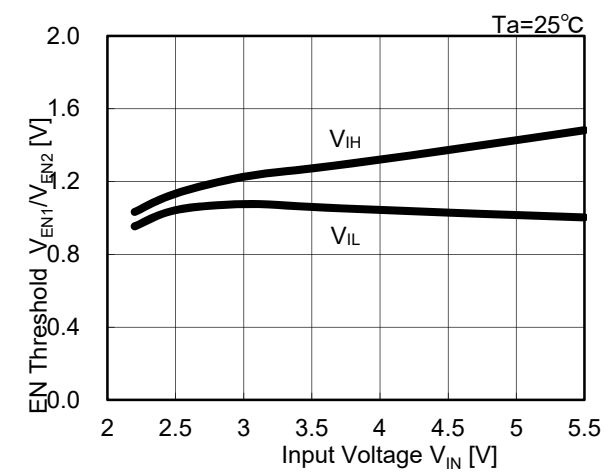

16) Flag Output Delay Time vs. Temperature

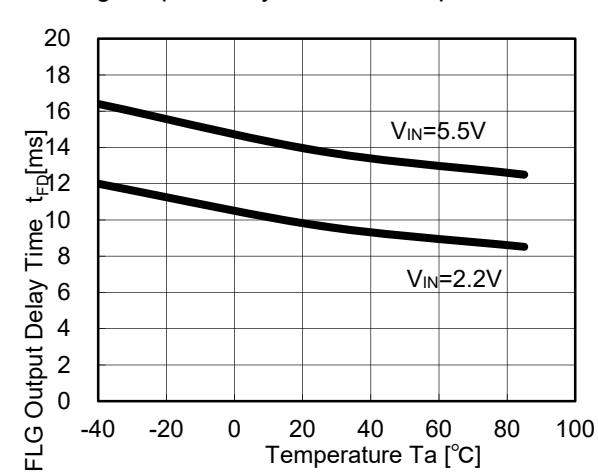

17) Flag Output Delay Time vs. V_{IN} Input Voltage

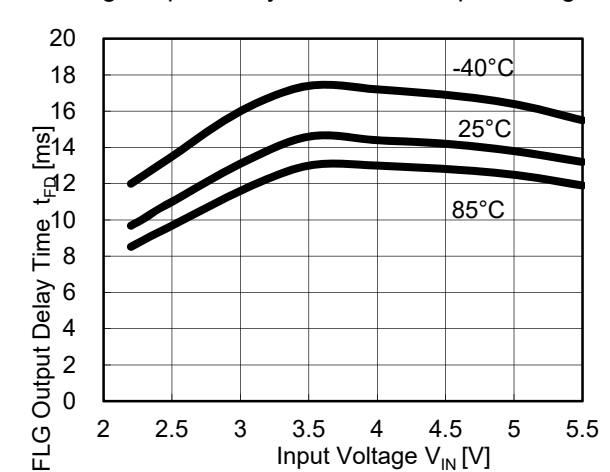

18) UVLO Threshold vs. Temperature

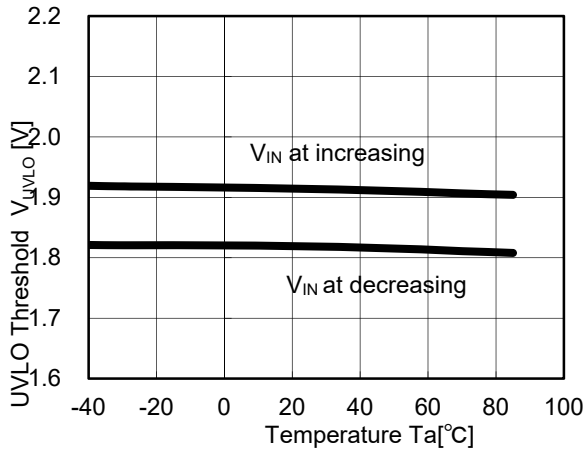

19) UVLO Characteristic at V_{IN} increasing

$V_{EN}=0V$, $C_L=47\mu F$, $R_L=35\Omega$

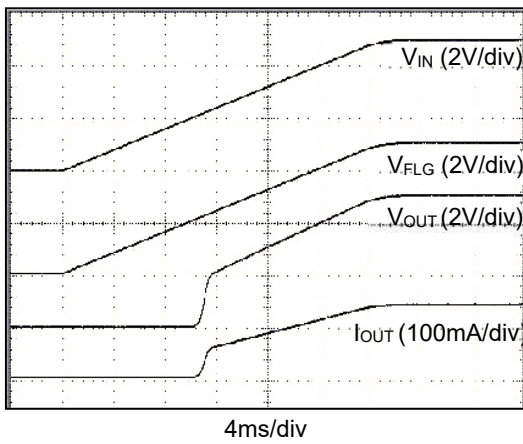

21) Turn Off Response

$V_{IN}=5V$, $C_L=47\mu F$, $R_L=35\Omega$

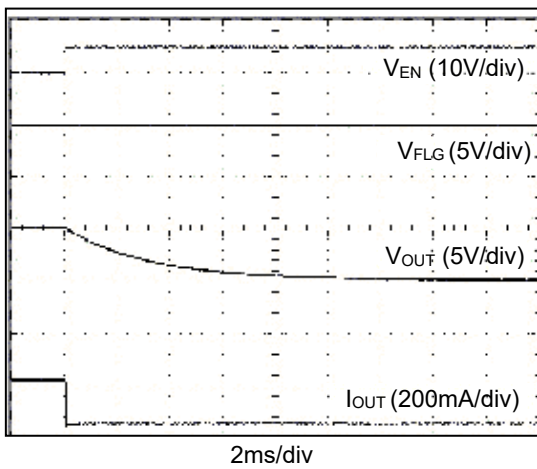

20) Turn on Response

$V_{IN}=5V$, $C_L=47\mu F$, $R_L=35\Omega$

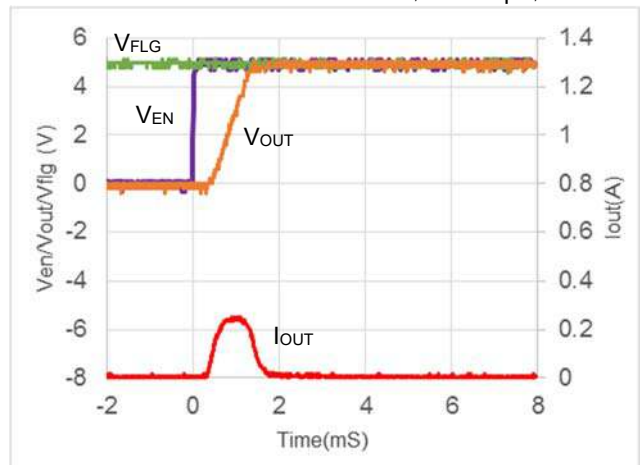

22) Inrush Current

$V_{IN}=5V$, $R_L=35\Omega$

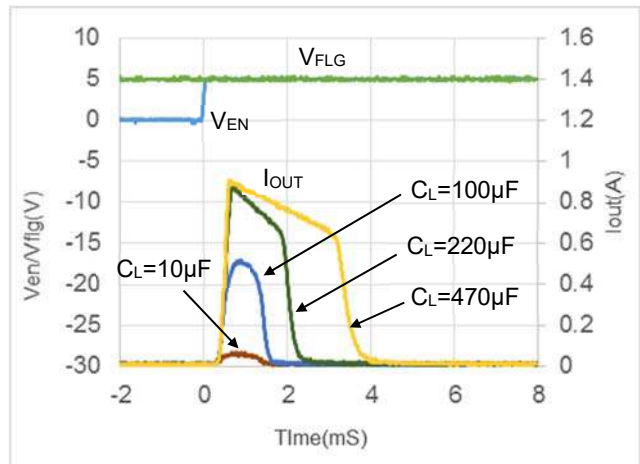

NO.EA-168-180516

23) Current Limit Transient Response
(Case: Enable to Short)

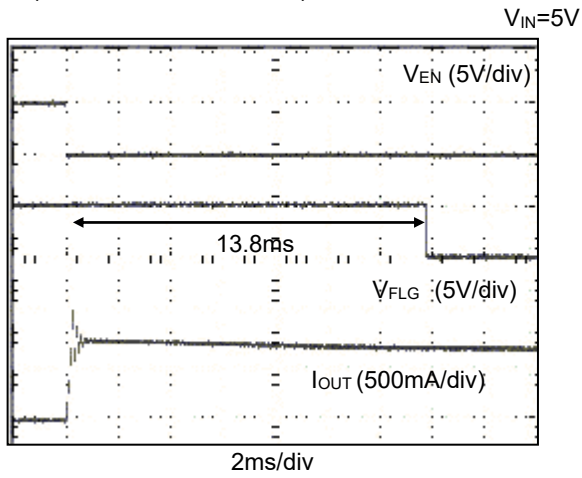

24) Thermal Shutdown Operation

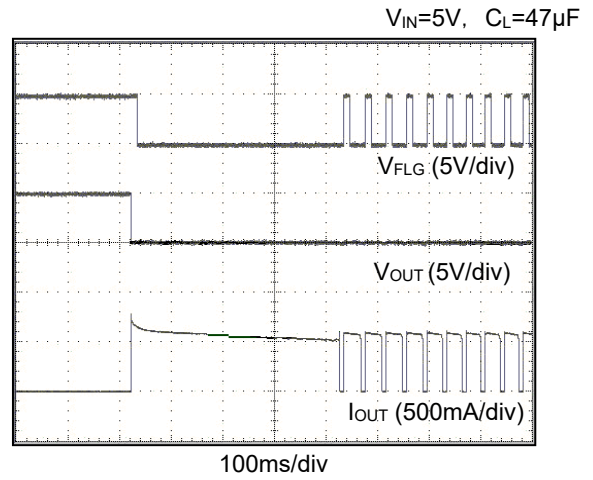

25) Current Limit Transient Response
(Case: Output short during enable)

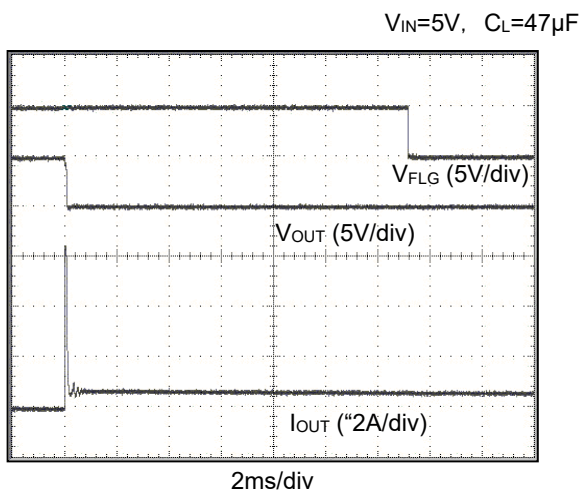

26) Zoomed in 25)

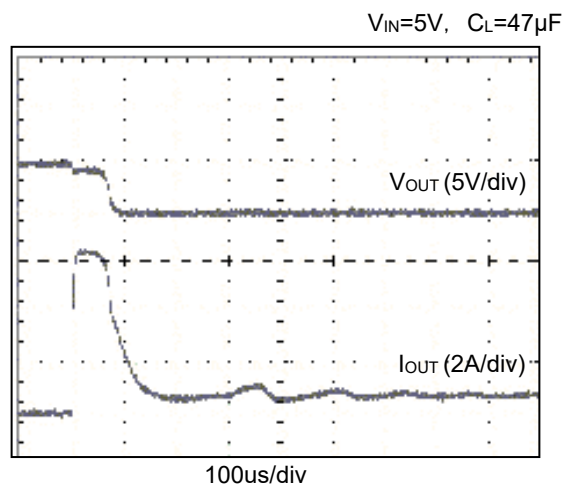

The power dissipation of the package is dependent on PCB material, layout, and environmental conditions. The following measurement conditions are based on JEDEC STD. 51-7.

Measurement Conditions

Item	Measurement Conditions
Environment	Mounting on Board (Wind Velocity = 0 m/s)
Board Material	Glass Cloth Epoxy Plastic (Four-Layer Board)
Board Dimensions	76.2 mm × 114.3 mm × 0.8 mm
Copper Ratio	Outer Layer (First Layer): Less than 95% of 50 mm Square Inner Layers (Second and Third Layers): Approx. 100% of 50 mm Square Outer Layer (Fourth Layer): Approx. 100% of 50 mm Square
Through-holes	φ 0.3 mm × 7 pcs

Measurement Result

(Ta = 25°C, Tjmax = 125°C)

Item	Measurement Result
Power Dissipation	660 mW
Thermal Resistance (θja)	θja = 150°C/W
Thermal Characterization Parameter (ψjt)	ψjt = 51°C/W

θja: Junction-to-Ambient Thermal Resistance

ψjt: Junction-to-Top Thermal Characterization Parameter

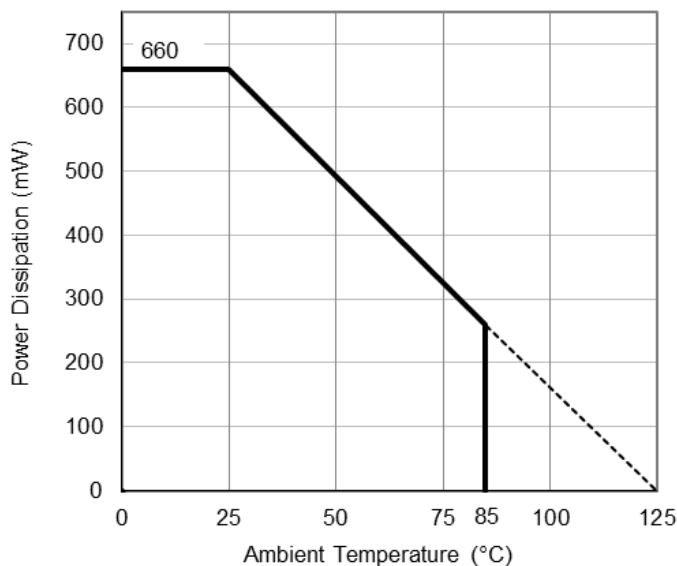

Power Dissipation vs. Ambient Temperature

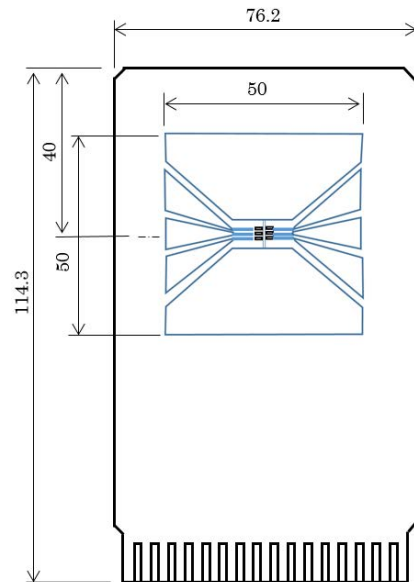

Measurement Board Pattern

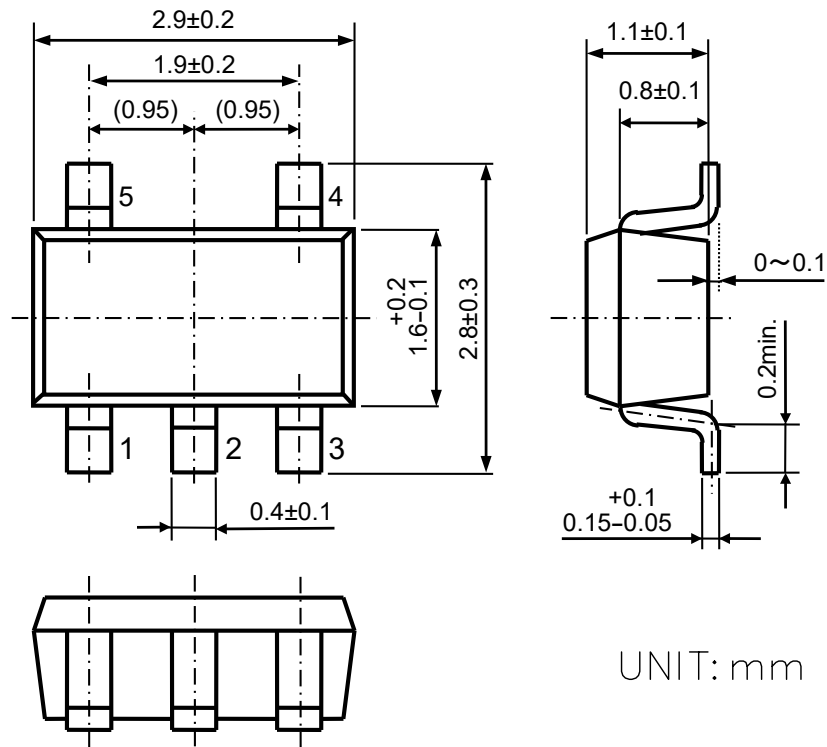

UNIT: mm

SOT-23-5 Package Dimensions



1. The products and the product specifications described in this document are subject to change or discontinuation of production without notice for reasons such as improvement. Therefore, before deciding to use the products, please refer to our sales representatives for the latest information thereon.
2. The materials in this document may not be copied or otherwise reproduced in whole or in part without prior written consent of our company.
3. Please be sure to take any necessary formalities under relevant laws or regulations before exporting or otherwise taking out of your country the products or the technical information described herein.
4. The technical information described in this document shows typical characteristics of and example application circuits for the products. The release of such information is not to be construed as a warranty of or a grant of license under our company's or any third party's intellectual property rights or any other rights.
5. The products listed in this document are intended and designed for use as general electronic components in standard applications (office equipment, telecommunication equipment, measuring instruments, consumer electronic products, amusement equipment etc.). Those customers intending to use a product in an application requiring extreme quality and reliability, for example, in a highly specific application where the failure or misoperation of the product could result in human injury or death (aircraft, spacevehicle, nuclear reactor control system, traffic control system, automotive and transportation equipment, combustion equipment, safety devices, life support system etc.) should first contact us.
6. We are making our continuous effort to improve the quality and reliability of our products, but semiconductor products are likely to fail with certain probability. In order to prevent any injury to persons or damages to property resulting from such failure, customers should be careful enough to incorporate safety measures in their design, such as redundancy feature, fire containment feature and fail-safe feature. We do not assume any liability or responsibility for any loss or damage arising from misuse or inappropriate use of the products.
7. Anti-radiation design is not implemented in the products described in this document.
8. The X-ray exposure can influence functions and characteristics of the products. Confirm the product functions and characteristics in the evaluation stage.
9. WLCSP products should be used in light shielded environments. The light exposure can influence functions and characteristics of the products under operation or storage.
10. There can be variation in the marking when different AOI (Automated Optical Inspection) equipment is used. In the case of recognizing the marking characteristic with AOI, please contact our sales or our distributor before attempting to use AOI.
11. Please contact our sales representatives should you have any questions or comments concerning the products or the technical information.



Nisshinbo Micro Devices Inc.

Official website

<https://www.nisshinbo-microdevices.co.jp/en/>

Purchase information

<https://www.nisshinbo-microdevices.co.jp/en/buy/>

