

LARISA-RS-CLIP16

~19° real spot beam. Clip fastening for 1.6 mm thick PCB

SPECIFICATION:

Dimensions	9.9 x 9.9 mm
Height	7.5 mm
Fastening	clips
ROHS compliant	yes ⓘ



MATERIALS:

Component	Type	Material	Colour	Finish
LARISA-RS	Single lens	PMMA	clear	
LARISA-HOLDER-CLIP16	Holder	PC	black	

ORDERING INFORMATION:

Component	Type	Qty in box	MOQ	MPQ	Box weight (kg)
CP12939_LARISA-RS-CLIP16 » Box size: 300 x 250 x 250 mm	Single lens	10000	300	100	5.8

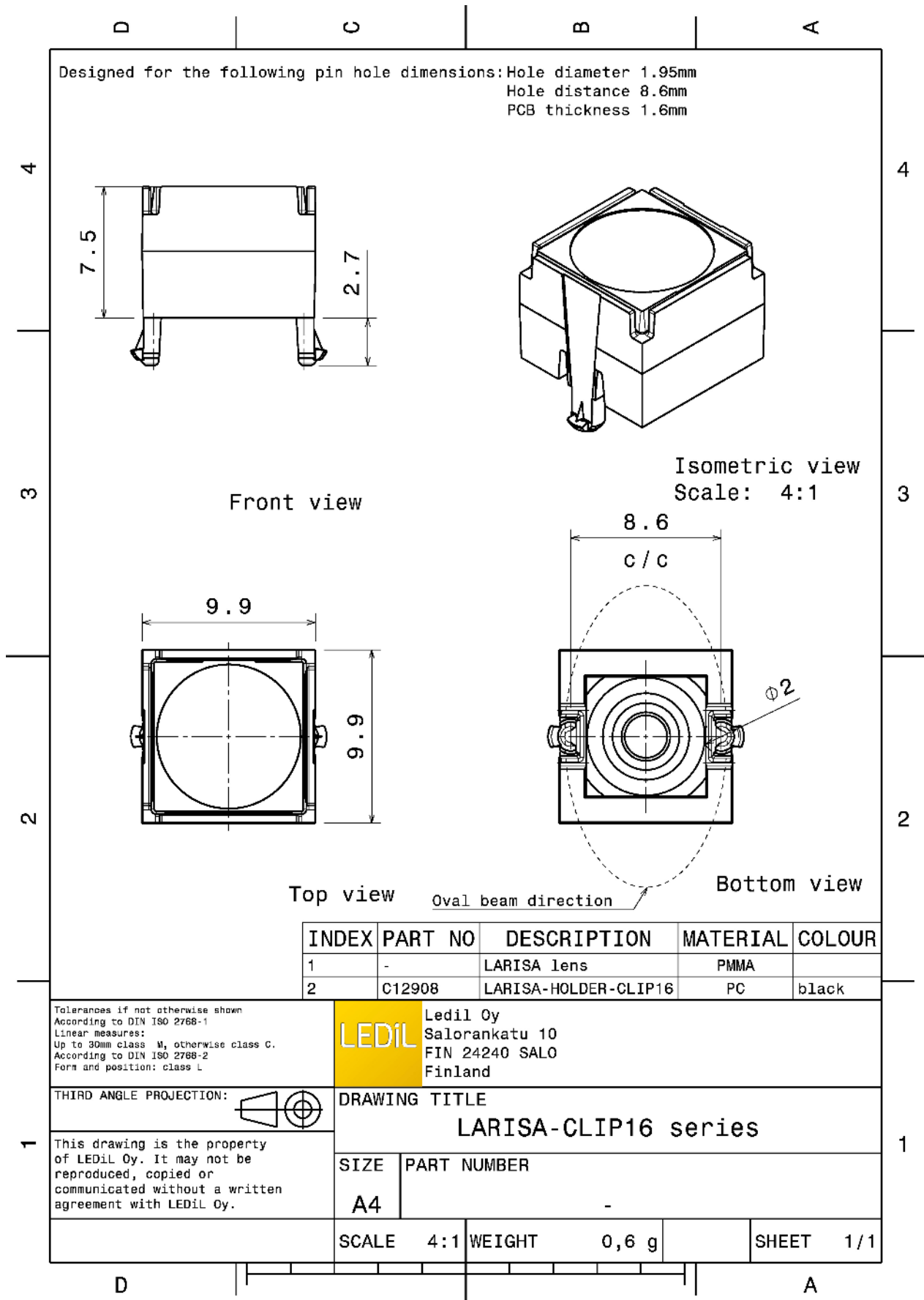

See also our general installation guide: www.ledil.com/installation_guide

OPTICAL RESULTS (MEASURED):

CREE LED

LED XD16
 FWHM / FWTM 18.0° / 40.0°
 Efficiency 80 %
 Peak intensity 4.8 cd/lm
 LEDs/each optic 1
 Light colour White
 Required components:

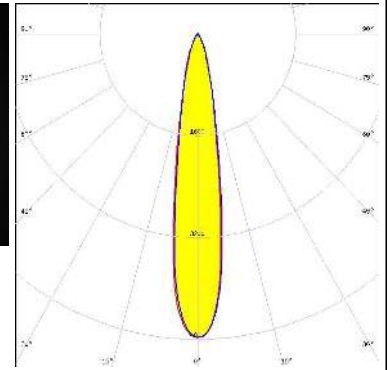
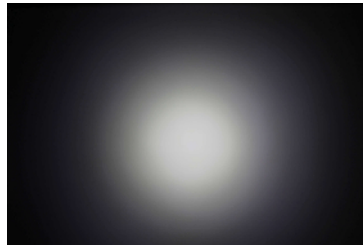

CREE LED

LED XQ-E HD
 FWHM / FWTM 16.0° / 33.0°
 Efficiency 86 %
 Peak intensity 6.9 cd/lm
 LEDs/each optic 1
 Light colour White
 Required components:

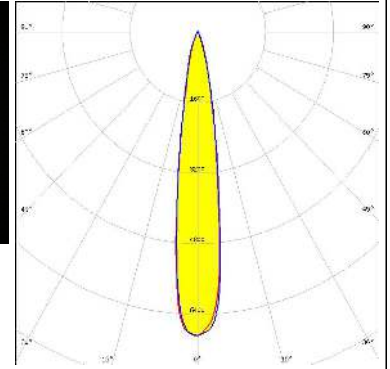

CREE LED

LED XQ-E HI
 FWHM / FWTM 11.0° / 28.0°
 Efficiency 80 %
 Peak intensity 10.7 cd/lm
 LEDs/each optic 1
 Light colour White
 Required components:

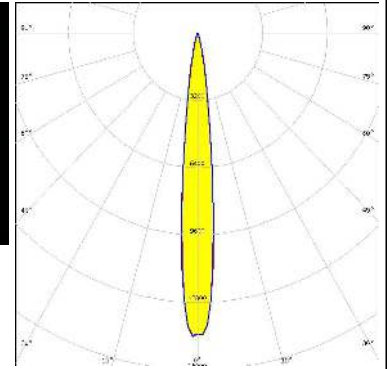



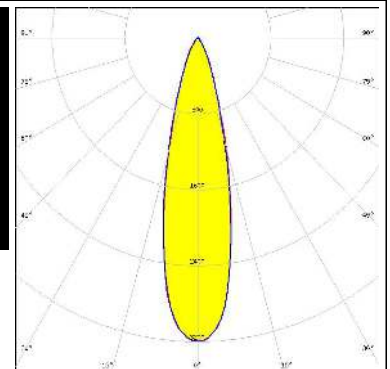
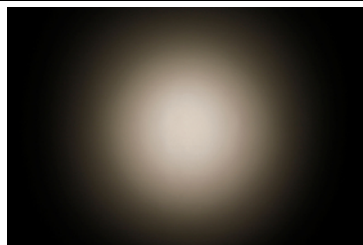

LUMILEDS



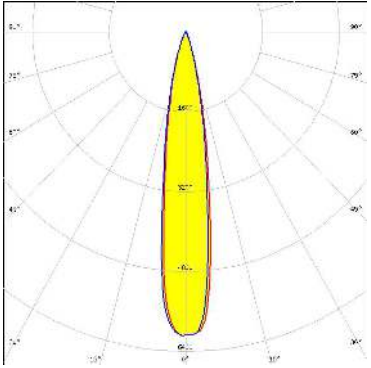

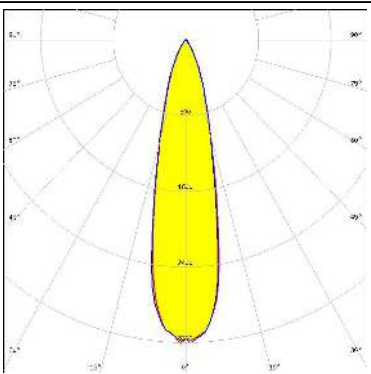
LED LUXEON A
 FWHM / FWTM 26.0° / 51.0°
 Efficiency 89 %
 Peak intensity 3.2 cd/lm
 LEDs/each optic 1
 Light colour White
 Required components:

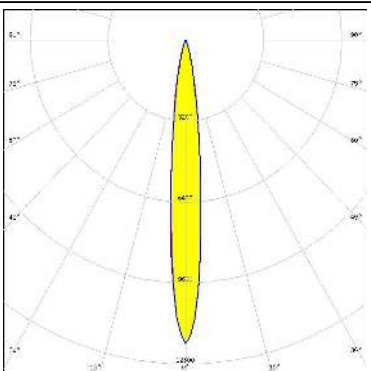

OPTICAL RESULTS (MEASURED):

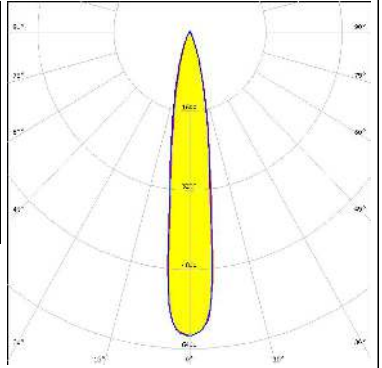
<p>LUMILEDS</p> <p>LED LUXEON C</p> <p>FWHM / FWTM 17.0° / 36.0°</p> <p>Efficiency 86 %</p> <p>Peak intensity 6.1 cd/lm</p> <p>LEDs/each optic 1</p> <p>Light colour White</p> <p>Required components:</p>		
<p>LUMILEDS</p> <p>LED LUXEON Rebel</p> <p>FWHM / FWTM 20.0° / 45.0°</p> <p>Efficiency 90 %</p> <p>Peak intensity 4.6 cd/lm</p> <p>LEDs/each optic 1</p> <p>Light colour White</p> <p>Required components:</p>		
<p>LUMILEDS</p> <p>LED LUXEON Rebel ES</p> <p>FWHM / FWTM 24.0° / 53.0°</p> <p>Efficiency 88 %</p> <p>Peak intensity 3.2 cd/lm</p> <p>LEDs/each optic 1</p> <p>Light colour White</p> <p>Required components:</p>		
<p>LUMILEDS</p> <p>LED LUXEON Z</p> <p>FWHM / FWTM 11.0° / 27.0°</p> <p>Efficiency 85 %</p> <p>Peak intensity 12.1 cd/lm</p> <p>LEDs/each optic 1</p> <p>Light colour White</p> <p>Required components:</p>		

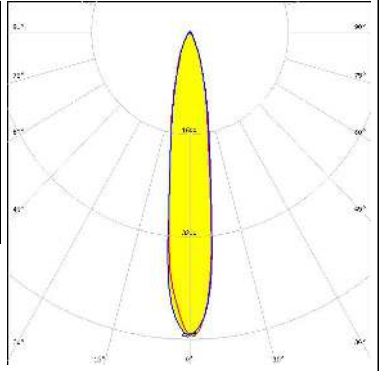
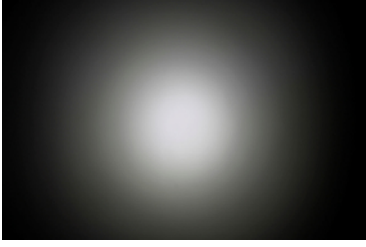
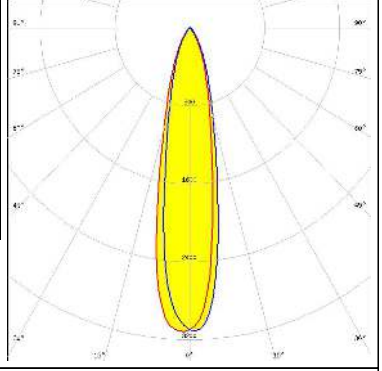
OPTICAL RESULTS (MEASURED):

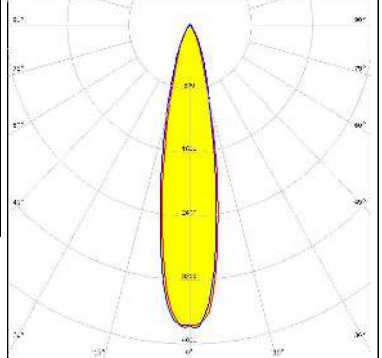
<p>LUMILEDS</p> <p>LED LUXEON Z ES</p> <p>FWHM / FWTM 16.0° / 37.0°</p> <p>Efficiency 89 %</p> <p>Peak intensity 6.1 cd/lm</p> <p>LEDs/each optic 1</p> <p>Light colour White</p> <p>Required components:</p>		
<p>NICHIA</p> <p>LED NCSxx19A</p> <p>FWHM / FWTM 16.0° / 43.0°</p> <p>Efficiency 84 %</p> <p>Peak intensity 4.8 cd/lm</p> <p>LEDs/each optic 1</p> <p>Light colour White</p> <p>Required components:</p>		
<p>NICHIA</p> <p>LED NVSxx19A</p> <p>FWHM / FWTM 21.0° / 52.0°</p> <p>Efficiency 81 %</p> <p>Peak intensity 3.1 cd/lm</p> <p>LEDs/each optic 1</p> <p>Light colour White</p> <p>Required components:</p>		
<p>OSRAM Opto Semiconductors</p> <p>LED OSOLON Square EC</p> <p>FWHM / FWTM 22.0° / 47.0°</p> <p>Efficiency 86 %</p> <p>Peak intensity 3.8 cd/lm</p> <p>LEDs/each optic 1</p> <p>Light colour White</p> <p>Required components:</p>		

OPTICAL RESULTS (MEASURED):

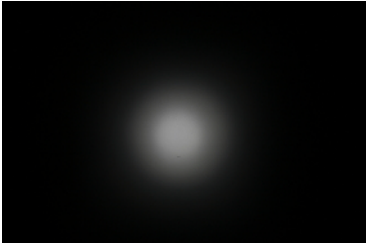
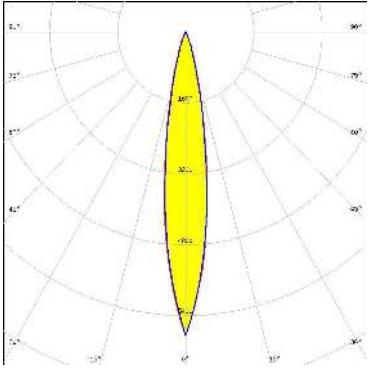
OSRAM Opto Semiconductors			
LED	OSLON SSL 150		
FWHM / FWTM	16.0° / 39.0°		
Efficiency	87 %		
Peak intensity	8.1 cd/lm		
LEDs/each optic	1		
Light colour	White		
Required components:			
OSRAM Opto Semiconductors			
LED	OSLON SSL 80		
FWHM / FWTM	16.0° / 36.0°		
Efficiency	83 %		
Peak intensity	6.5 cd/lm		
LEDs/each optic	1		
Light colour	White		
Required components:			

OPTICAL RESULTS (SIMULATED):



GENERAL INFORMATION:

NOTE: The typical beam angle will be changed by different color, chip size and chip position tolerance. The typical total beam angle is the full angle measured where the luminous intensity is half of the peak value.

MATERIALS:

As part of our continuous research and improvement processes, and to ensure the best possible quality and availability of our products, LEDiL reserves the right to change material grades without notice.

PRODUCT DATA USER AGREEMENT AND DISCLAIMER:

The measured data in the provided downloadable LEDiL Product Datasheets and Mechanical 2D-Drawings is rounded and provided as reference for planning. LEDiL Oy's optical specifications have been verified by conducting performance testing of the products in accordance with the company's quality system. The reported data are averaged results of multiple measurements with typical variation. LEDiL Oy reserves the right to without prior notification make changes and improvements to its products.

LEDiL Oy assumes neither warranty, nor guarantee nor any other liability of any kind for the contents and correctness of the provided data. The provided data has been generated with highest diligence but the provided data may in reality not represent the complete possible variation range of all intrinsic parameters. Therefore, in certain cases a deviation from the provided data could occur.

LEDiL Oy reserves the right to undertake technical changes of its products without further notification which could lead to changes in the provided data. LEDiL Oy assumes no liability of any kind for the possible deviation from any provided data or any other damage resulting from the usage of the provided data.

The user agrees to this disclaimer and user agreement with the download or usage of the provided files.

LEDiL Oy

Joensuunkatu 13
FI-24240 SALO
Finland

LEDiL Inc.

228 West Page Street
Suite D
Sycamore IL 60178
USA

Ledil Optics Technology (Shenzhen) Co., Ltd.

405 , Block B
Casic Motor Building
Shenzhen 518057
P.R.CHINA

Local sales and technical support

[www.ledil.com/
where_to_buy](http://www.ledil.com/where_to_buy)

Shipping locations

Salo, Finland
Hong Kong, China

Distribution Partners

[www.ledil.com/
where_to_buy](http://www.ledil.com/where_to_buy)