

REV.	ECN NO.	DATE	SIGN	DESCRIPTION
A		2022-03-07	Jiahe Lin	Rev.01 To Rev.A

MSDS-XXPFFR-EE0001

XX: No. Of Pin

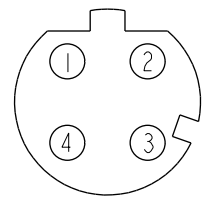
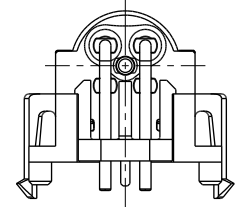
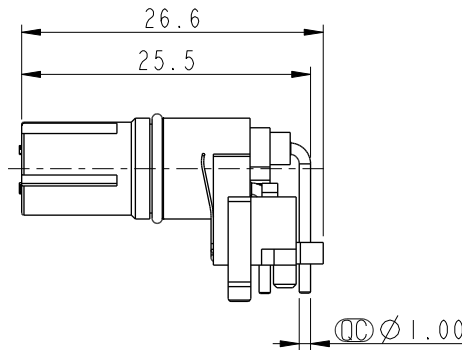
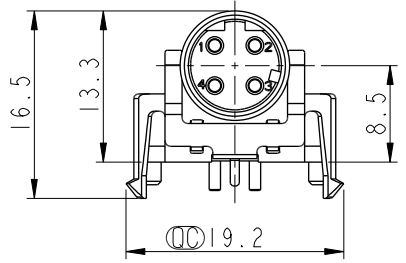
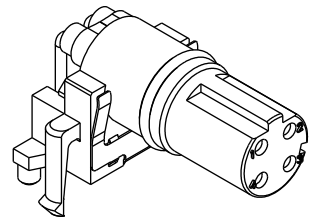
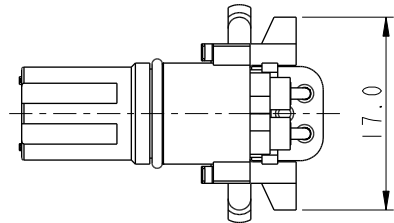

4P

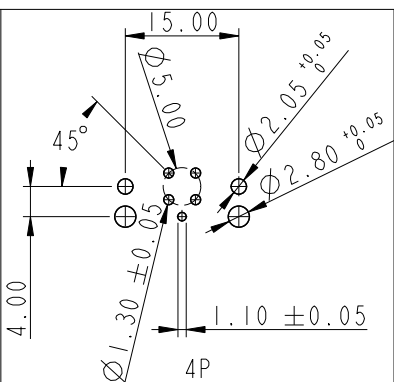

PCB Layout

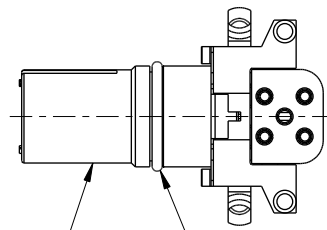

Connector O-Ring

- Note:
- * RoHS Compliant
 - * \varnothing Important dimension
 - * Waterproof rate: Non-Waterproof
 - * Connector
 - Housing: Thermoplastic, Black
 - Pin: Copper alloy, Gold plated
 - O-Ring: Rubber, Gray
 - * For pcb thickness max: 1.6mm

UNIT:mm		
TOLERANCE	.X ±0.25	
	.XX ±0.1	
	.XXX ±0.05	
ANGLES	±1°	

TITLE N SEN, M12 D -SHLD, RECEPTACLE, F, F, PCB R		
SCALE 3:2	SIZE A4	SHEET 1 OF 1
REV. A	WC-REV. A.1	\varnothing : Inspection item

Amphenol LTW
安費諾亮泰企業股份有限公司

ITEM NO	DRAWN BY Jiahe Lin	DATE 2022-03-07
DWG NO MSDS-XXPFFR-EE0001	CHECKED BY Allen Pan	DATE 2022-03-07
CUSTOMER ALTW	APPROVED BY Fred Lee	DATE 2022-03-07

THIS DOCUMENT IS SUBJECT TO CHANGE WITHOUT NOTICE. IT IS CONFIDENTIAL AND A PROPERTY OF Amphenol LTW. DISCLOSURE TO THIRD PARTY HAS TO BE AUTHORIZED BY Amphenol LTW.