

Infrared Array Sensor Grid-EYE



High Precision Infrared Array Sensor based on Advanced MEMS Technology

Features

- Temperature detection of two-dimensional area: 8 × 8 (64 pixels)
- Digital output (capability of temperature value output)
- Compact SMD package (adaptively to reflow mounting)
- RoHS compliant

Typical Applications

- High function home appliances (microwaves and air-conditioners)
- Energy saving at office (air-conditioning/lighting control)
- Digital signage
- Automatic doors/elevators

Ordering Information

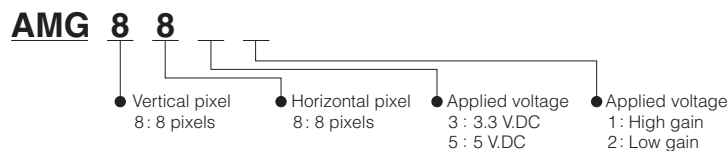

Types

Product name	Number of pixel	Operating voltage	Amplification factor	Part number
Infrared array sensor Grid-EYE	64 (Vertical 8 × Horizontal 8 Matrix)	3.3 V.DC	High gain	AMG8831
			Low gain	AMG8832
		5.0 V.DC	High gain	AMG8851
			Low gain	AMG8852

Tape and reel package : 1,000 pcs.

Rating

Item	Performance	
	High gain	Low gain
Applied voltage	3.3 V.DC±0.3 V.DC or 5.0 V.DC±0.5 V.DC	
Temperature range of measuring object	0 °C to 80 °C +32 °F to +176 °F	-20 °C to 100 °C -4 °F to +212 °F
Operating temperature range	0 °C to 80 °C +32 °F to +176 °F	-20 °C to 80 °C -4 °F to +176 °F
Storage temperature range	-20 °C to 80 °C -4 °F to +176 °F	-20 °C to 80 °C -4 °F to +176 °F

Absolute Maximum Ratings

Item	Absolute maximum ratings	Terminal
Applied voltage	-0.3 V.DC to 6.5 V.DC	VDD
Input voltage	-0.3 V.DC to VDD +0.3 V.DC	SCL, SDA, AD_SELECT
Output sink current	-10 mA to 10 mA	INT, SDA
Static electricity (Human body model)	1 kV	All terminals
Static electricity (Machine model)	200 V	All terminals

Characteristics

Item	Performance	
	High gain	Low gain
Temperature accuracy	Typical ± 2.5 °C ± 4.5 °F	Typical ± 3.0 °C ± 5.4 °F
Human detection distance *1	Max. 5 m 16.404 ft	
Viewing angle	Typical 60 °	
Optical axis gap	Within Typical ± 5.6 °	
Current consumption	Typical 4.5 mA (normal mode) Typical 0.2 mA (sleep mode) Typical 0.8 mA (stand-by mode)	
Setup time	Typical 50 ms (Time to enable communication after setup) Typical 15 s (Time to stabilize output after setup)	

Note: *1 To have more than 4 °C 7.2 °F of temperature difference from background
Detection object size: 700 × 250 mm 27.559 × 9.843 inch (Assumable human body size)

Performance

Item	Performance
Number of pixel	64 (Vertical 8 × Horizontal 8 Matrix)
External interface	I ² C (fast mode)
Frame rate	Typical 10 frames/sec or 1 frame/sec
Operating mode *1	Normal Sleep Stand-by (10 sec or 60 sec intermittence)
Output mode	Temperature output
Calculate mode	No moving average or Twice moving average
Temperature output resolution	0.25 °C
Number of sensor address	2 (I ² C slave address)
Thermistor output temperature range	-20 °C to 80 °C -4 °F to +176 °F
Thermistor output resolution	0.0625 °C

Note: *1 Normal Mode : normal operation mode; Sleep Mode: detection is off (output and data reading not possible); Standby Mode: 1 frame measuring intermittently every 10 or 60 sec.

Internal Circuit

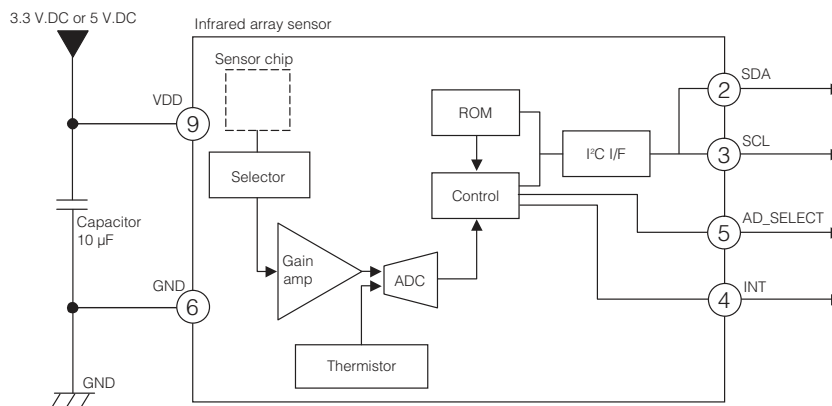

* INT terminal ④ normally has same voltage as VDD. When interrupting, same as GND (0V)

Pixel Array And Viewing Field

(1) Pixel array
Pixel array from 1 to 64 is shown below.

(2) Viewing field
Sensor viewing field (typical) is shown below.

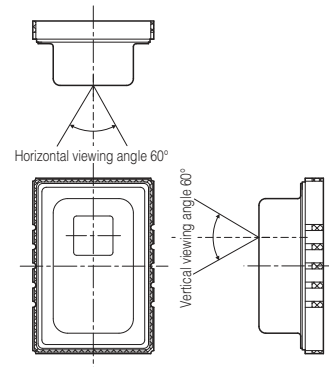
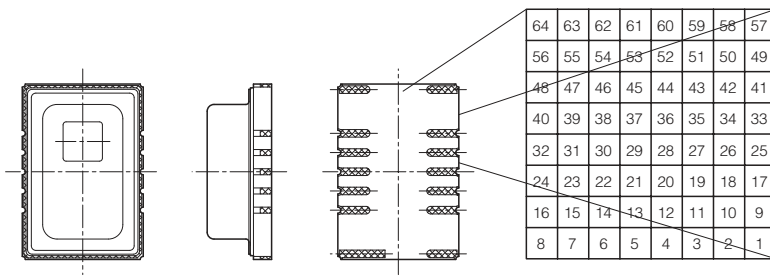

Optical Properties

(1) Each pixel's viewing central angle
Sensor's optical center (the origin of graph below) gap: within $\pm 5.6^\circ$ (Typical) (Both horizontal and vertical directions)

(2) Each pixel's viewing angle (half angle)
Central 4 pixels (Pixel No. 28, 29, 36, 37) viewing angle (half angle): horizontal direction 7.7° (Typical) vertical direction 8° (Typical)

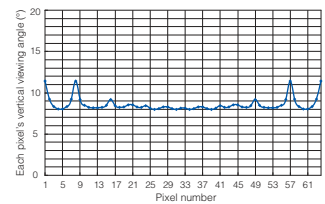
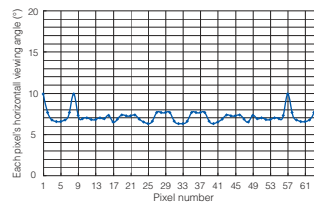
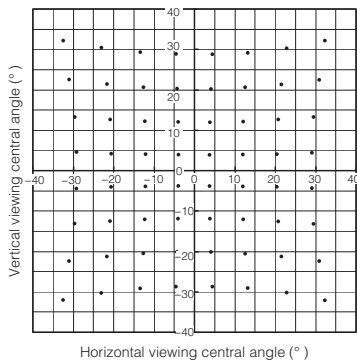

Dimensions

External dimensions

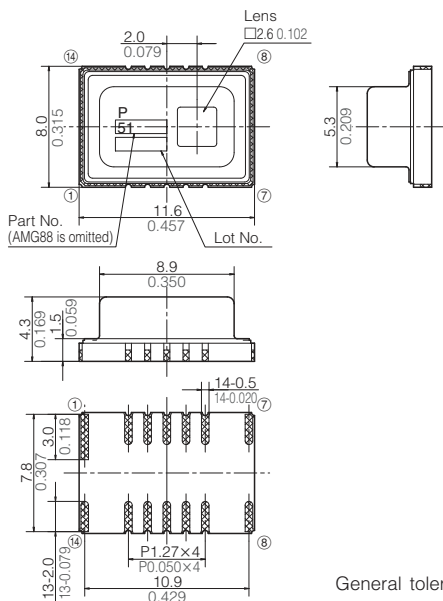

General tolerance : $\pm 0.2 \pm 0.08$

Recommended PC board pad

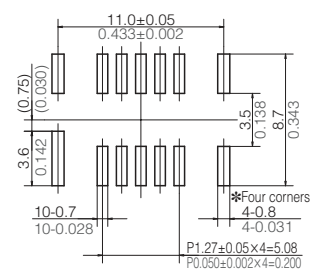

Number	Terminal Name	Number	Terminal Name
①	NC	⑧	NC
②	SDA	⑨	VDD
③	SCL	⑩	AVDD-PC
④	INT	⑪	NC
⑤	AD_SELECT	⑫	DVDD-PC
⑥	GND	⑬	VPP
⑦	NC	⑭	NC

Note : Leave terminal "NC (No. ①, ⑦, ⑧, ⑪ and ⑭)" unconnected.
Make electrical potential of terminals ⑨ and ⑬ the same.

unit : mm inch

External Circuit

- (1) In case of setting I²C slave address of the sensor 1101000
 * Connect terminal ⑤ (AD_SELECT) to GND.

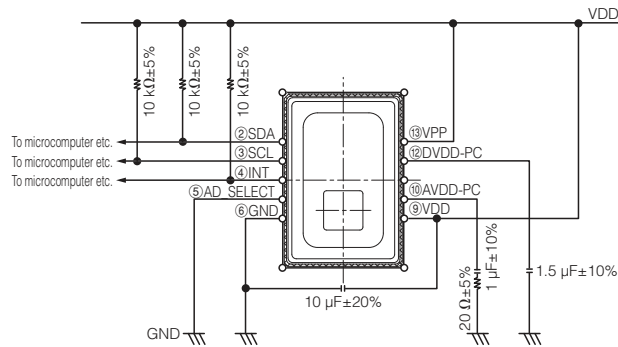

- (2) In case of setting I²C slave address of the sensor 1101001
 * Connect terminal ⑤ (AD_SELECT) to VDD.

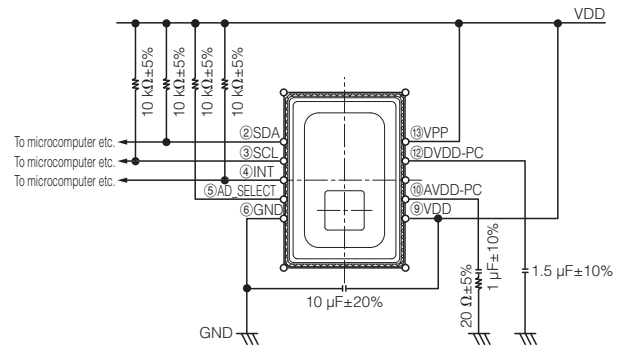

This circuit is an example to drive infrared array sensor "Grid-EYE", so that we will not take any responsibility of loss which is due to this circuit.

Packing Format (Tape and Reel)

Tape dimensions

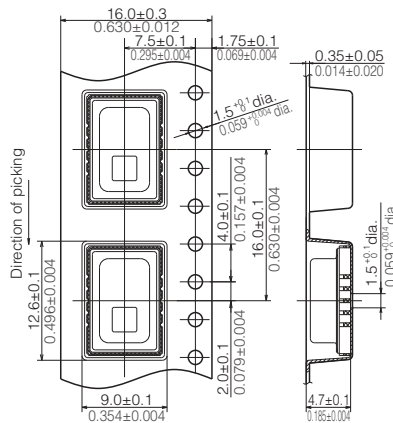

Dimensions of tape reel

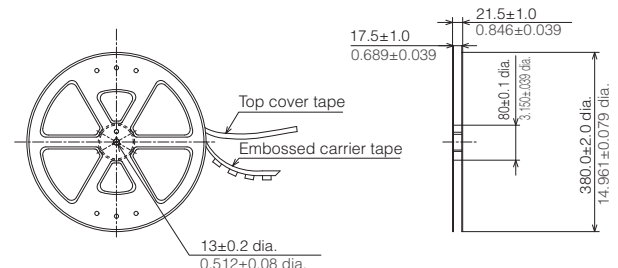

unit : mm inch

Packing Format (Tape and Reel)

■ Precaution for fundamental structure of sensor

Infrared Array Sensor is a thermopile type infrared sensor which detects the amount of infrared rays. Below conditions generally degrade the temperature accuracy. Carefully check the performance and stability under actual use conditions, and perform temperature corrections when necessary.

- When heating elements exist near the mounting position of the sensor.
- When the sensor is exposed to cold or hot air.
- When the temperature of the sensor body rapidly changes.
- When substances (e.g., glasses, acrylics or steams), which hardly transmit a far infrared ray, exist between the sensor and the detected object.
- When substances (e.g., foreign substances or water), which hardly transmit a far infrared ray, adhere to the lense of the sensor.

■ Use environment

- 1) Temperature: See the specifications
- 2) Humidity: Between 15% and 85% R.H. (Avoid freezing and dew condensation)
- 3) Atmospheric pressure: Between 86 and 106 kPa

- 4) Vibrations and shocks may damage the sensor, and cause malfunction and performance deterioration. If loads and shocks are applied on the lense, the damaged sensor may cause malfunction and performance deterioration.
- 5) The product is not water/splash-proof. Perform water/dust-proofing and dew condensation/freezing countermeasures in accordance with use environment. When dew condensation occurs, responsiveness of heat source detection may delay for several seconds.
- 6) Avoid use and storage in the corrosive gas (organic solvent, sulfurous acid and hydrogen sulfide gases) to avoid malfunction and performance deterioration.
- 7) Use surge absorbers as applying the external surge voltage may damage the internal circuit.
- 8) Malfunction may occur near electric noises from static electricity, lightning, broadcast or amateur radio stations and mobile phones.
- 9) The sensor can continuously operate within the range of using ambient temperature (using ambient humidity). However, ensure that humidity is within the range described in the following page as humidity varies according to temperature. Avoid the continuous operation near the operational limit. The temperature range does not guarantee the durability.

Other precautions

These specifications are for individual components. Before use, carefully check the performance and quality under actual use conditions to enhance stability.

- 1) Once the individual sensor is dropped, do not use. Drop may cause functional disorders.
- 2) Writing to the unspecified register/with the unspecified bit may cause malfunction and performance deterioration. (please consult us)
- 3) Misconnection and use beyond the specified temperature range may damage the product.
- 4) Once below shocks are applied, do not use the product as applying highfrequency oscillation to the sensor body may damage the product.
 - Contact with metal objects
 - Contact with other sensors
- 5) Follow the instructions below as static electricity may damage the product.
 - For storage and transportation, avoid plastic containers which are easily electrified.
 - When storing and transporting the sensor, choose the environment where static electricity is hardly generated (e.g., humidity between 45 and 60 %) and protect the product by using electroconductive packaging materials.
 - Once unpacked, perform antistatic countermeasures.
 - (1) Operators handling sensors must wear antistatic cloths and human body grounding devices.
 - (2) Cover the surface of workbench by electro-conductive plates and ground measuring instruments and jigs.
 - (3) Use the soldering iron which has a small leakage current or ground the soldering tip.
 - (4) Ground the assembling equipment.
 - Use a stabilized power supply. A power superimposed noise may cause malfunction.

Range of using ambient temperature (using ambient humidity)

The sensor can continuously operate within the range of using ambient temperature (using ambient humidity). However, ensure that humidity is within the range below as humidity varies according to temperature. Avoid the continuous operation near the operational limit. Before use, check the stability under the usage environment as high humidity or high temperatures generally accelerates deterioration of the electronic component.

- The temperature range does not guarantee the durability

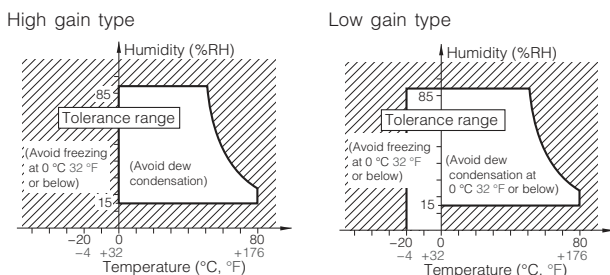

Mounting

Use the land of the printed-circuit board on which the sensor is securely fixed. The recommended printed-circuit board is FR4 (thickness 1.6 mm 0.063 inch). When mounting on the deprecated circuit board, carefully check the performance and quality under actual use conditions before use.

- A large noise on the power supply may cause malfunction. Place the recommended capacitor near the sensor (within 20 mm 0.787 inch of the wiring pattern length) between sensor input terminals (VDD-GND) to secure power superimposed noise resistance. Test with the actual machine and re-select the capacitor with optimal capacitance.
- Prevent the metal part of other electronic components from contacting with the sensor body as the upper face (where part numbers are imprinted) of the sensor is GND.

Soldering

When soldering, avoid the external thermal influence. Heat deformation may damage the sensor or deteriorate its performance. Use the non-corrosive rosin flux.

1) Manual soldering

- Raise the temperature of the soldering tip between 350 and 400 °C 662 and 752 °F (30 and 60 W) and solder within 3 seconds.
- The sensor output may vary if the load is applied on the terminal during soldering.
- Keep the soldering tip clean.

2) Reflow soldering

Below are recommended temperature profiles/conditions of reflow.

- When printing cream solder, the screen printing method is recommended.
- For the foot pattern, see the recommended diagram of the printed-circuit board.
- Carefully align the terminal with the pattern as self-alignment may not be reliable.
- The temperature of the profile is the value measured near the terminal on the printed-circuit board.
- After reflowing, when performing reflow soldering on the back surface of the circuit board, use an adhesive to fix the board.

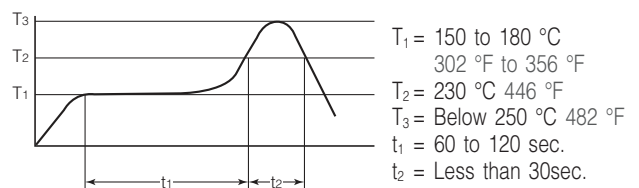

- 3) After soldering, do not apply stress on the soldered part when cutting or bending the circuit board.
- 4) Rework soldering
 - Complete rework at a time.
 - Use a flattened soldering tip when performing rework on the solder bridge. Do not add the flux.
 - Keep the soldering tip below the temperature described in the specifications.
- 5) Prevent human hands or metal pieces from contacting with the sensor terminal. Such contact may cause anomalous outlets as the terminal is exposed to the atmosphere.
- 6) After soldering, prevent chemical agents from adhering to the sensor when applying coating to avoid insulation deterioration of the circuit board.

■ Wire connection

- 1) Correctly wire as in the connection diagram. Reverse connection may damage the product and degrade the performance.
- 2) Do not use idle terminals. Such use may damage the sensor.
- 3) For cable wiring, use shield wires with possibly short wiring lengths to prevent the influence of the noise.

■ Cleaning

Avoid ultrasonic cleaning as this may cause disconnection of the wire.

■ Storage and transportation

- 1) Excessive vibrations and shocks during transport may damage the product. Carefully handle the exterior box and the reel.
- 2) Extremely bad storage conditions may deteriorate solderability or characteristics, and defect the appearance. Recommended conditions of the storage place are below.
 - Temperature: 0 to 45 °C 32 to 113 °F
 - Humidity: Below 70 % R.H.
 - Atmosphere: Low-dust and free from noxious chemicals such as sulfurous acid gas
- 2) The package is moisture-proof due to its sensitivity to humidity. When storing the sensor, follow the instructions below.
 - Promptly use after opening. (within a week, below 30 °C 86 °F/60 % R.H.)
 - Once unpacked, preserving in a moisture-proof manner, such as keeping in a moisture-proof bag with silica gels, is recommended for long-term storage. (use within 3 months)

* During soldering, when adding thermal stress in a moisture absorbing state, moisture evaporates, swells and generates stress to the internal package. To avoid swellings and cracks in the surface of the package, follow the soldering conditions.

■ Special notes

We exert maximum efforts for quality control of the product, however :

- 1) To prevent occurrence of unexpected circumstances, please inform us of the specifications of your product, customers, use conditions and details of the attachment position.
- 2) Have sufficient margin values of driving/performance guarantee described in the specifications and apply safety measures with double circuits, if serious effects on human lives or property are predicted due to a quality failure of the product. Those countermeasures are also for the product liability.

- 3) A warranty period is one year after the delivery to your company. Quality assurance is limited to the items and the scopes described in the specifications.

If a defect is found after the delivery, we will promptly provide a replacement or change/repair the defect part at the place of delivery in good faith. Exceptions are below.

- Damages by a failure or a defect which arose after the delivery.
- After the delivery, when storing and transporting, if conditions other than conditions in the specifications are applied to the product.
- Damages by unforeseen phenomenon which cannot be predicted with the technologies available at the time of delivery.
- Damages by natural and anthropogenic disasters, such as earthquake, flood, fire and war, which are beyond our reasonable control.

■ Export control

[Customers within Japan]

This product is subject to the Foreign Exchange and Foreign Trade Act enacted by the Japanese government. When exporting the product from Japan or taking the product out of Japan, export permission from the Japanese government is required. (as of Aug 2015). Do not use the product for other purposes. When disposing surplus stock or inventory, prevent unauthorized reuse and do not sell the products to the third party.

[Customers outside Japan]

This product is subject to the laws concerning security export control (the Foreign Exchange and Foreign Trade Act) enacted by the Japanese government. We obtain export permission by the Japanese government in order to resale/provide the products. Do not use the product for other purposes. If exporting the product from your country, laws or regulations of the country may restrict the export. When disposing surplus stock or inventory, prevent unauthorized reuse and do not sell the products to the third party.