

UNCONTROLLED DOCUMENT

PART NUMBER
SSL-LXA228AC-TR31

REV.
C

REV.	E.C.N. NUMBER AND REVISION COMMENTS	DATE
A	E.C.N. #10695. &10BRDR.	1.5.01
B	E.C.N. #10762.	6.18.01
C	E.C.N. #11148	11.14.06

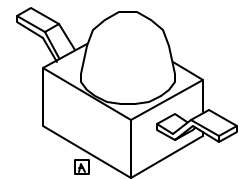
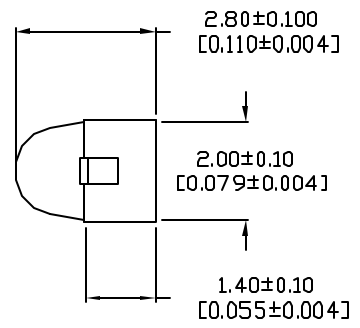
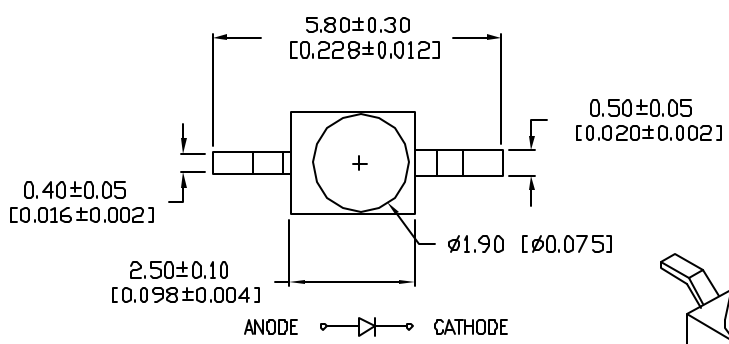

ELECTRO-OPTICAL CHARACTERISTICS $T_A=25^{\circ}\text{C}$ $I_f=20\text{mA}$

PARAMETER	MIN	TYP	MAX	UNITS	TEST COND
PEAK WAVELENGTH		605		nm	
FORWARD VOLTAGE		2.1	2.8	V_f	
REVERSE VOLTAGE	5.0			V_r	$I_f=100\mu\text{A}$
AXIAL INTENSITY		80		mcd	$I_f=20\text{mA}$
VIEWING ANGLE		25		2x theta	
EMITTED COLOR:	AMBER				
EPOXY LENS FINISH:	WATER CLEAR				

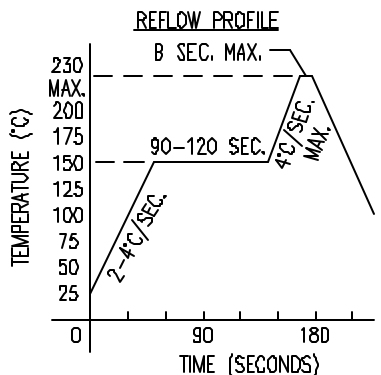
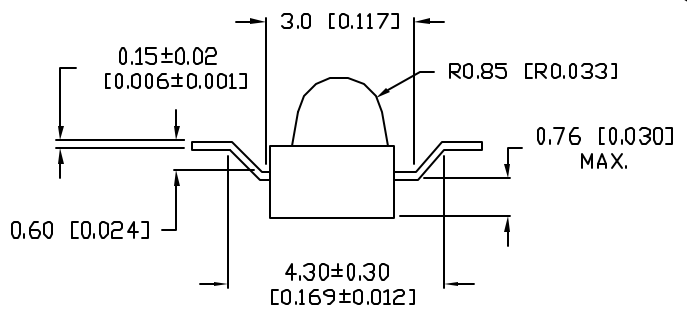

LIMITS OF SAFE OPERATION AT 25°C PER DIE

PARAMETER	MAX	UNITS
PEAK FORWARD CURRENT*	150	mA
STEADY CURRENT	30	mA
POWER DISSIPATION	105	mW
DERATE FROM 25°C	-1.2	mW/°C
OPERATING, STORAGE TEMP.	-40 TO +85	°C
SOLDERING TEMP.	+260	°C
2.0mm FROM BODY	3 SEC. MAX	

* $t < 10\mu\text{s}$

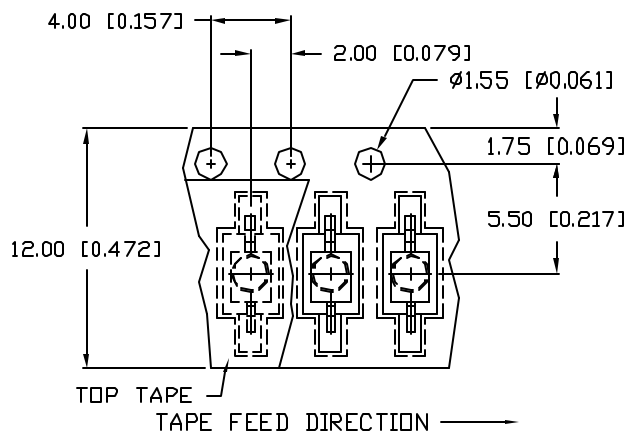

RECOMMENDED SOLDER PAD LAYOUT

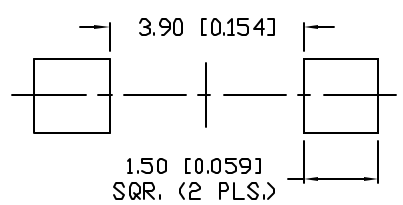

NOTES:

- 1,000 PIECES PER REEL.
- THE CATHODE IS ORIENTED TOWARDS THE TAPE SPROCKET HOLE.



UNCONTROLLED DOCUMENT

*UNLESS OTHERWISE SPECIFIED TOLERANCES PER DECIMAL PRECISION ARE: X=±1 (±0.038), XX=±0.5 (±0.020), XXX=±0.25 (±0.010), XXXX=±0.127 (±0.005). LEAD SIZE=±0.05 (±0.002), LEAD LENGTH=±0.75 (±0.030), MIN=+DECIMAL PRECISION MAX=-DECIMAL PRECISION

REV. C	PART NUMBER SSL-LXA228AC-TR31
-----------	----------------------------------

CONFIDENTIAL INFORMATION
THE INFORMATION CONTAINED IN THIS DOCUMENT IS THE PROPERTY OF LUMEX INC. EXCEPT AS SPECIFICALLY AUTHORIZED IN WRITING BY LUMEX INC, THE HOLDER OF THIS DOCUMENT SHALL KEEP ALL INFORMATION CONTAINED HEREIN CONFIDENTIAL AND SHALL PROTECT SAME IN WHOLE OR IN PART FROM DISCLOSURE AND DISSEMINATION TO ALL THIRD PARTIES.



290 E. HELEN ROAD
PALATINE, IL 60067-6976
PHONE: +1.847.359.2790
US WEB: www.lumex.com
TW WEB: www.lumex.com.tw

605nm AMBER, AXIAL LED,
WATER CLEAR LENS, Z BEND, TAPE AND REEL.

RELIABILITY NOTE
OUR MANY YEARS OF EXPERIENCE DATA ACCUMULATION INDICATE THAT SOLDER HEAT IS A MAJOR CAUSE OF EARLY AND FUTURE FAILURE. PLEASE PAY ATTENTION TO YOUR SOLDERING PROCESS.

DRAWN BY: JC	CHECKED BY:	APPROVED BY:	DATE: 11.14.06
			PAGE: 1 OF 1
			SCALE: N/A