

# AsahiKASEI

**Magnetic Solution Provider**  
**A Small Sensor Opens the Way to Future Technologies**

## Sensor Solution

Asahi Kasei's Hall sensors are playing an active part in your everyday world.  
They contribute to the high accuracy, long life,  
and compact designs of various systems as well as their good-looking appearance and usability.  
As a leading company of magnetic sensors,  
Asahi Kasei will continuously offer innovative sensor technologies.

**ASAHI KASEI EMD Corp.**

1-23-7 Nishi-Shinjuku, Shinjuku-ku, Tokyo 160-0023, Japan Phone: +81-3-6911-2800 [www.asahi-kasei.co.jp/ake/en/](http://www.asahi-kasei.co.jp/ake/en/)

**North America Distributor: GMW Associates**

955 Industrial Rd., San Carlos, California 94070, USA Phone: +1 (650) 802-8292 [www.gmw.com](http://www.gmw.com)

- HW, HS series
- Hall element
- HG series
- HQ, HZ series

- EW series
- Hall IC
- EM series
- EZ series

Asahi Kasei EMD is the world leader in Hall elements. The main applications of our Hall elements are the brushless motors used in CD/DVD drives and fans. At present, we are manufacturing these elements to over 1 billion in a year. With a wide range of package variants and materials, we can address diversifying customer needs.

- Package: SOP, DIP, SIP, SON, etc.
- Material: HW, HS series (InSb) Ultra high sensitivity
- HG series (GaAs) Improved temperature characteristics
- HQ, HZ series (InAs): High sensitivity, improved temperature characteristics

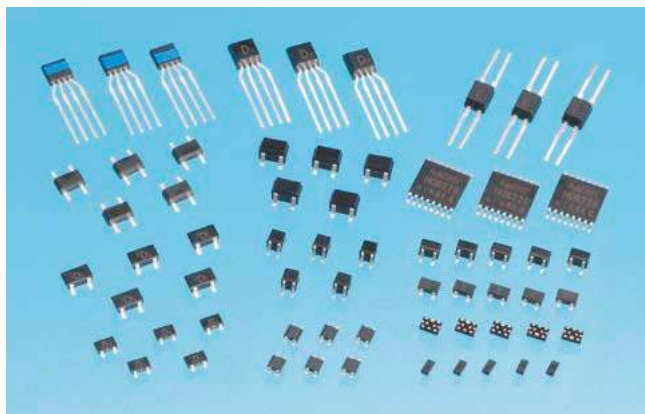

\*For further details, refer to the Hall element catalog.

Asahi Kasei EMD is manufacturing Hall ICs by utilizing high-sensitivity Hall elements and our proprietary signal processing technologies. With the wide lineups varying in operation type, Operating point, and package size, our products are being used in various applications from OA equipment and electric appliances to mobile appliances. We also offer substantial design supports based on our rich experiences in the magnetic simulation and magnetic field measurement.

- Detection type: Unipolar switch, Omnipolar switch, Bipolar Latch
- Package: SOP, SON, SIP
- Operating point: 1.5, 3, 6, or 10 mT depending on the type
- Supply voltage: 1.8, 3, 5, 12, or 24 V depending on the type
- Operating temperature: 85, 115, or 125°C depending on the type

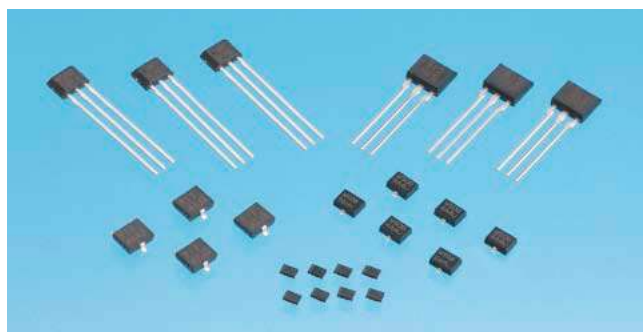

\*For further details, refer to the Hall effect IC.

## Multi-chip Hall IC for pointing devices EQ-8441

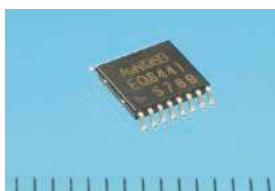

### Features

- 2D position detection digital output:** Integrates four Hall elements and one control IC into a single package. Integrates a 8-bit A/D converter to output serial signals corresponding to detected X/Y positions
- Low power consumption:** Integrates an intermittent operation circuit, power down function
- Interruption function:** No need for constant reading because this function alerts the host to any operation of the pointing device.

### Block diagram (EQ-8441)

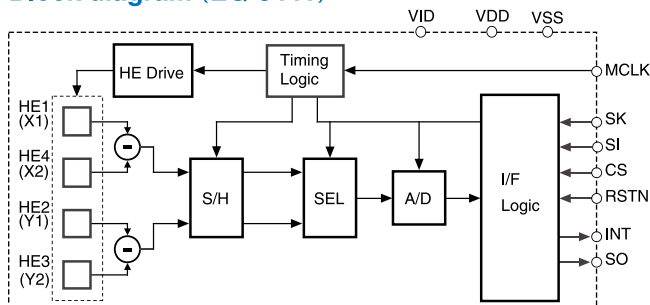

### Main specifications: EQ-8441

Item	Symbol	Condition	Unit	Min	Typ.	Max.
Supply voltage	VDD		V	2.5	3.0	3.3
I/F voltage	VID		V	1.75	1.85	VDD
Current consumption	IDD1	Power down mode	μA		0.5	5
	IDD2	Sensor drive	mA		3.9	6.3
	IDD3	External clock mode	μA		6	19
	IDD4	Internal clock mode	μA		26	46
ADC resolution	RSL		bit		8	
Sampling cycle	SINT2	External clock mode	ms		15.63	
	SINT1	Internal clock mode	ms	6.3	10	16.4
Master clock frequency	FCLK1	External clock mode	kHz		32.77	
	FCLK2	Internal clock mode	kHz	250	400	650

### Operation principle

Four Hall elements detect the magnetic field generated by a magnet. The IC reads the differences across the magnetic flux density values given by these elements, and thus determines the current position of the magnet as a set of 2D coordinate data.

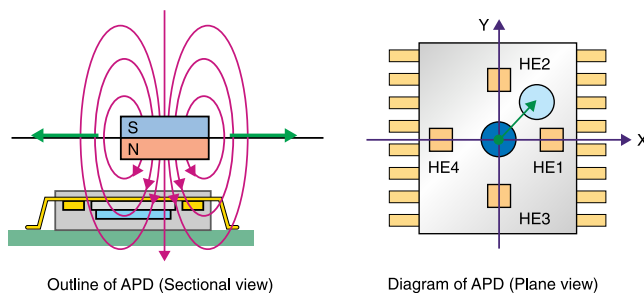

X-axis	Y-axis	Detected position
HE1 output = HE4 output	HE2 output = HE3 output	Magnet is at center
HE1 output > HE4 output	HE2 output > HE3 output	Magnet is at upper right

# Hall sensor for close position sensing

## Features

- Simple configuration made up of a magnet and a Hall element
- Resistant to dirt and dust
- Allows detection with accuracy up to  $\mu\text{m}$  order
- Wide range of line ups
- Allows compact design
- No time decay in output
- High quality design support, magnetic field measurement, and magnetic simulation based on our rich experiences

## Major applications (actual implementations)

- Position detection for lens and CCD in DSC, DVC anti-shake systems
- Position detection for autofocus lens and zoom lens

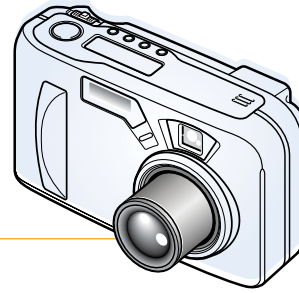

## Typical designs for close position Sensing

### Displacement of magnet

#### Design sample I

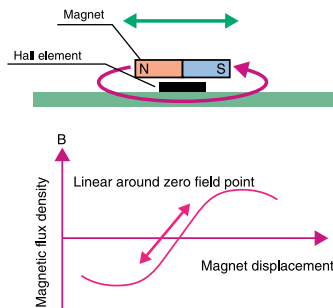

#### Hall element in use: HG series

##### Improved temperature characteristics

**SOP package**  
HG-106C/106A/166A/176A/186A



**SON package**  
HG-0111/0112/0113/0114/0115



### Hall Output voltage

#### Design II

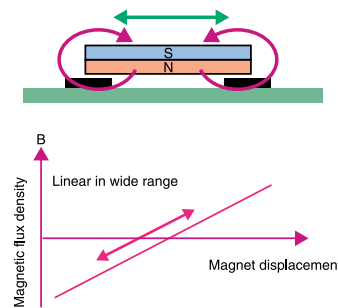

\*The difference between outputs of the two Hall elements is detected.

#### Hall element in use: HQ series

##### High sensitivity

##### Multi chip package (Multiple Hall elements with equivalent characteristics into one package)

**HQ-8220**  
Four elements, 3.1 mm pitch

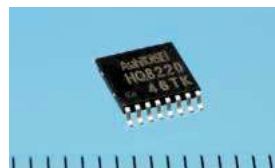

**HQ-0441**  
Four elements, 3.1 mm pitch



**HQ-0221**  
Two elements, 0.8 mm pitch



**HQ-0222**  
Two elements, 1.5 mm pitch



**HQ-0223**  
Two elements, 3.0 mm pitch

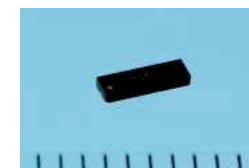

#### Design III

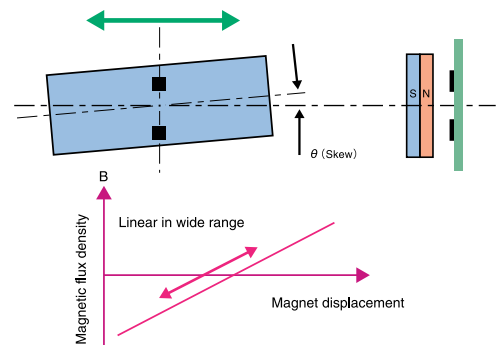

\*The difference between outputs of the two Hall elements is detected.

## Feasible stroke and accuracy (by magnetic simulations)

**Design I**  
Stroke: Accuracy  
1 mm:  $\pm 1\mu\text{m}$

**Design II**  
Stroke: Accuracy  
1 to 5 mm:  $\pm 1$  to  $5\mu\text{m}$   
Temperature characteristics  
can be cancelled

**Design III**  
Stroke: Accuracy  
5 to 10 mm:  $\pm 5$  to  $10\mu\text{m}$   
Temperature characteristics  
can be cancelled

(Note) The accuracy represents displacement from a linear curve.

We will propose an optimum design based on your requests (stroke, accuracy).

## Rotation angle sensor ■ AE-8001 ■ EM-3241 (under development)

- Features** - Rotation angle sensor using a Hall element  
 - Detects the rotation angle of a radially magnetized disc magnet as an absolute angle

### AE-8001

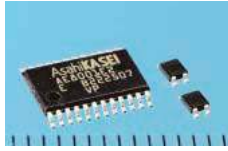

- Consists of three chips of two Hall elements and one processing IC
- Hall elements in use are SMT (HZ-116C) and SIP (HZ-312C)
- Resolution: 12 bits
- Output format
  - Ratiometric analog output
  - 12-bit digital output
- Integrates non-volatile memories, allowing user programming
- Supply voltage: 5 V
- Operating temperature range: -40 to 125°C

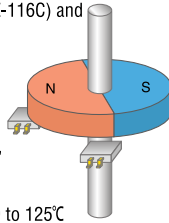

### EM-3241 (under development)

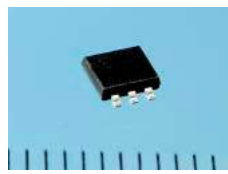

- Integrates a Hall element and a processing IC into a single package
- Ultra-compact 6-pin package: 3.6 x 3.0 x 0.95 mm
- Resolution: 9 bits (10-bit version is being developed.)
- Output format
  - Ratiometric analog output
- Supply voltage: 3 to 5 V
- Operating temperature range: -30 to 85°C

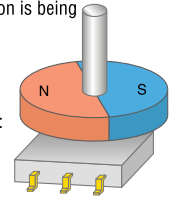

## Linear Hall IC ■ EQ-70L ■ EQ-40L, EG-70L, EG-40L (under development)

- Features** - Integrates a high-sensitivity Hall element and a processing IC into a single package

### EQ-70L, EQ40L (under development)



- Ratiometric analog output
- Magnetic sensitivity: 68 mV/mT
- Supply voltage: 5 V
- Package:
  - SIP EQ-70L
  - SMT EQ-40L (under development)

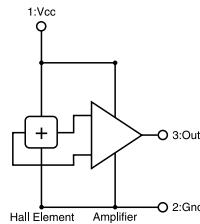

### EG-70L, EG-40L (under development)

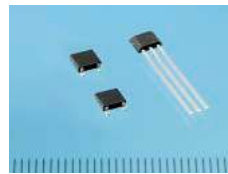

- Ratiometric analog output
- Magnetic sensitivity: 20 mV/mT
- Supply voltage: 5 V
- Package:
  - SIP EG-70L (under development)
  - SMT EG-40L (under development)

## Hall driver IC ■ EM-300,301

### EM-300,301

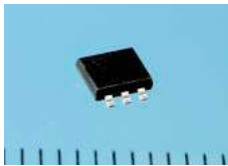

- Integrates a Hall element and a processing IC into a single package
- Driven with two-phase half wave
- Supply voltage: 3.5 to 15 V
- Motor current: 500 mA
- With lock monitor terminal
- EM-300: Tachometer signal output
- EM-301: Alarm signal output

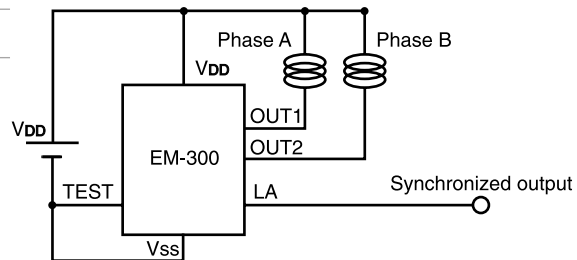

## Current sensor ■ CQ-120E,130E



- Features**
- Ultra-compact open type current sensor
  - Compliant to IEC standard for insulation
  - Quick response: 5μs

### CQ-120E

- Rated current: 20 A
- Supply voltage: 5 V

### CQ-130E

- Rated current: 30 A
- Supply voltage: 5 V

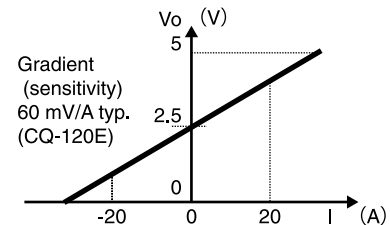

## Semiconductor magnetoresistive element ■ MS-0040,0020 (under development)

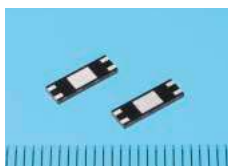

- Features**
- Detects a rotation angle with high accuracy by the combination of a semiconductor magnetoresistive element and a bias magnet
  - Improved temperature characteristics of output voltage
  - Detects the phases A/B
  - Two versions available,  $m = 0.2$  and  $m = 0.4$

