

SST130U-600D 0.8A TRIACs

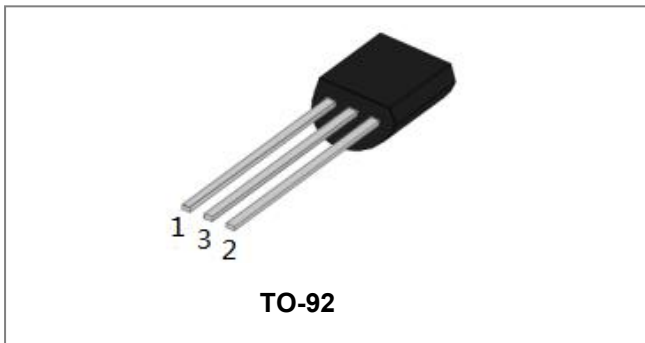

Circuit Diagram

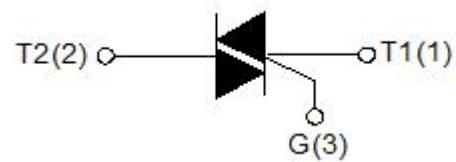

Description

With low holding and latching current, SST130 series triacs are especially recommended for use on middle and small resistance type power load.

Maximum Ratings:

Characteristics	Symbol	Condition	Max.	Units
Storage junction temperature range	T_{stg}	-	-40 - 150	°C
Operating junction temperature range	T_j	-	-40 - 125	°C
Repetitive peak off-state voltage ($T_j=25^\circ\text{C}$)	V_{DRM}	-	600	V
Repetitive peak reverse voltage ($T_j=25^\circ\text{C}$)	V_{RRM}	-	600	V
Non repetitive surge peak off-state voltage	V_{DSM}	-	$V_{DRM}+100$	V
Non repetitive peak reverse voltage	V_{RSM}	-	$V_{RRM}+100$	V
RMS on-state current	$I_{(TRMS)}$	TO-92($T_c=50^\circ\text{C}$)	0.8	A
Non repetitive surge peak on-state current (full cycle, F=50Hz)	I_{TSM}	-	400	A
I^2t value for fusing ($t_p=10\text{ms}$)	I^2t	-	880	A^2s
Critical rate of rise of on-state current ($I_G=2 \times I_{GT}$)	di/dt	I - II - III	50	A/us
		IV	20	
Peak gate current	I_{GM}	-	1	A
Average gate power dissipation	P_{GM}	-	0.1	W
Peak gate power	$P_{G(AV)}$	-	1	W

Electrical Characteristics ($T_j=25^\circ\text{C}$ unless otherwise specified)

Symbol	Test Condition	Quadrant		Value		Unit
				D	T	
I_{GT}	$V_D=12V$	I - II - III	MAX	5	5	mA
		IV		10	5	
V_{GT}		ALL	MAX	1.3		V
V_{GD}	$V_D=V_{DRM}$ $T_j=125^\circ\text{C}$ $R_L=3.3K\Omega$	ALL	MIN	0.2		V
I_L	$I_G=1.2I_{GT}$	I - III - IV	MAX	10	5	mA
		II		20	15	
I_H	$I_T=100\text{mA}$		MAX	7	5	mA
dV/dt	$V_D=2/3V_{DRM}$ Gate Open $T_j=125^\circ\text{C}$		MIN	30	10	V/ μs

Static Characteristics

Symbol	Condition	Max.	Units
V_{TM}	$I_T=1.1A$ $t_p=380\mu\text{s}$, $T_j=25^\circ\text{C}$	1.5	V
I_{DRM}	$V_D=V_{DRM}$ $V_R=V_{RRM}$, $T_j=25^\circ\text{C}$	5	μA
I_{RRM}	$V_D=V_{DRM}$ $V_R=V_{RRM}$, $T_j=125^\circ\text{C}$	100	μA

Thermal Resistances

Symbol	Condition	Value	Units
$R_{th(j-c)}$	Junction to case(AC) TO-92	75	$^\circ\text{C/W}$

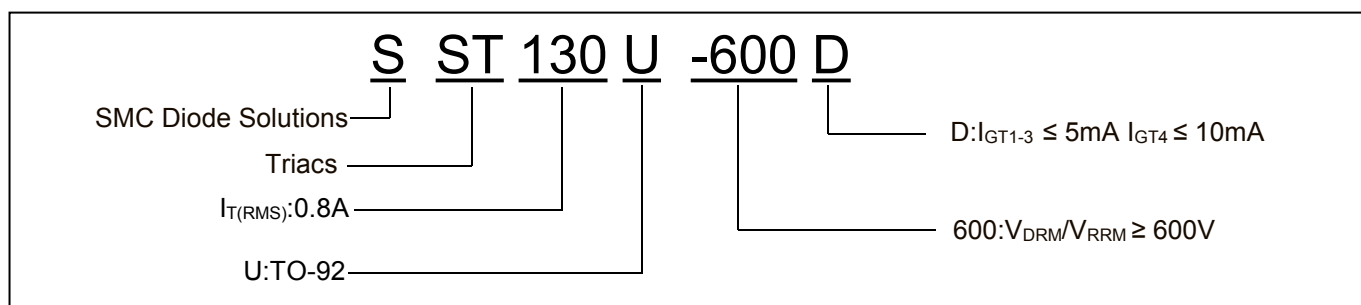
Ordering Information

Device	Package	Shipping
SST130U-600D	TO-92	2000pcs/ reel
SST130U-600DTR	TO-92	2000pcs/ reel

Marking Diagram

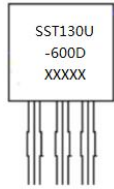

Where XXXXX is YYWWL

SST130U-600D = Part name
YY = Year
WW = Week
L = Lot Number

Mechanical Dimensions TO-92

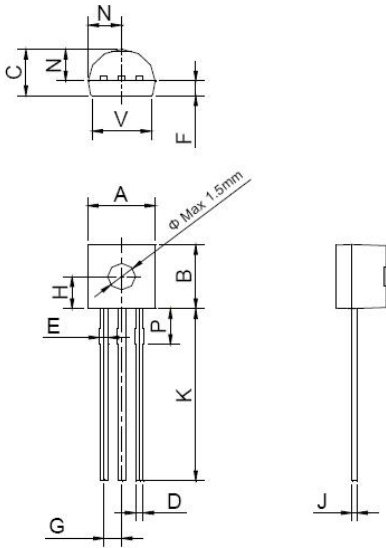

SYMBOL	Millimeters			Inches		
	Min.	Typ.	Max.	Min.	Typ.	Max.
A	4.45	-	5.20	0.175	-	0.205
B	4.32	-	5.33	0.170	-	0.210
C	3.18	-	4.19	0.125	-	0.165
D	0.407	-	0.533	0.016	-	0.021
E	0.60	-	0.80	0.024	-	0.031
F	-	1.1	-	-	0.043	-
G	-	1.27	-	-	0.050	-
H	-	2.30	-	-	0.091	-
J	0.36	-	0.50	0.014	-	0.020
K	12.70	-	15.0	0.500	-	0.591
N	2.04	-	2.66	0.080	-	0.105
P	1.86	-	2.06	0.073	-	0.081
V	-	-	4.3	-	-	0.169

Ratings and Characteristics Curves

FIG.1: Maximum power dissipation versus RMS on-state current

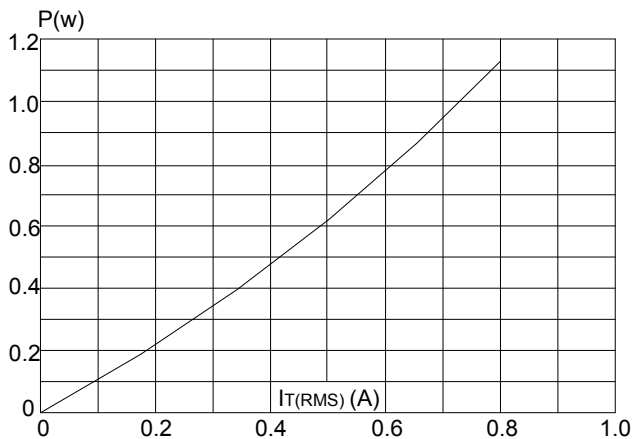

FIG.2: RMS on-state current versus case temperature

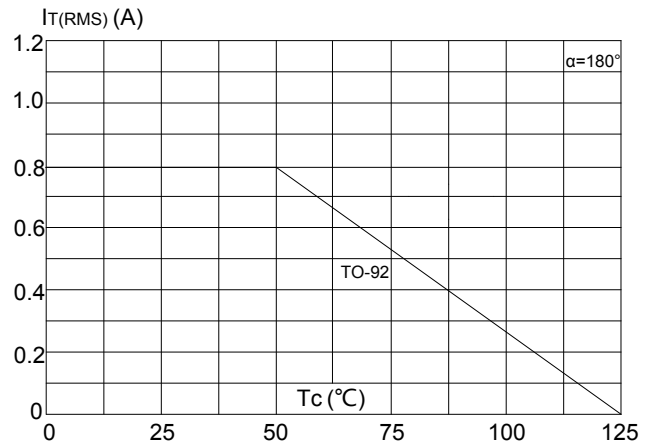



FIG.3: Surge peak on-state current versus number of cycles

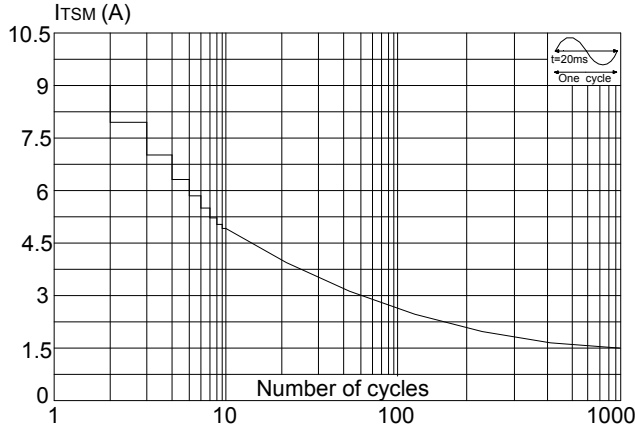

FIG.4: On-state characteristics (maximum values)

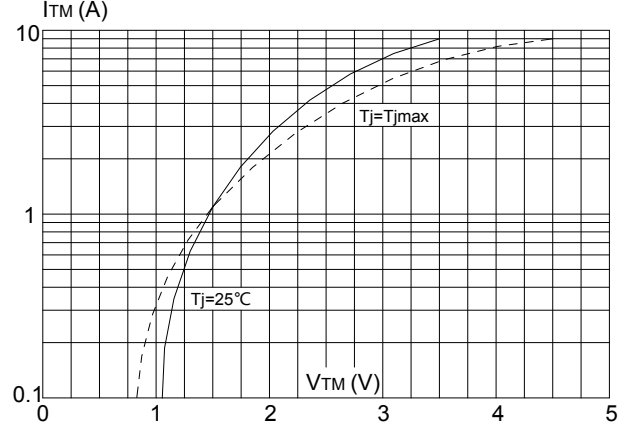

FIG.5: Non-repetitive surge peak on-state current for a sinusoidal pulse with width $t_p < 20\text{ms}$ (I - II - III: $di/dt < 50\text{A}/\mu\text{s}$; IV: $di/dt < 20\text{A}/\mu\text{s}$)

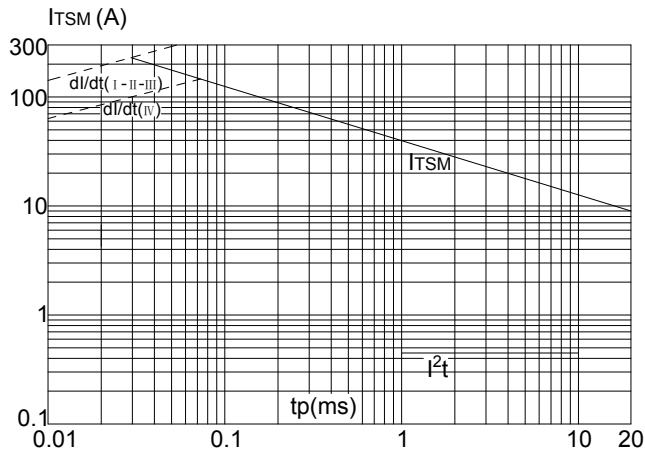
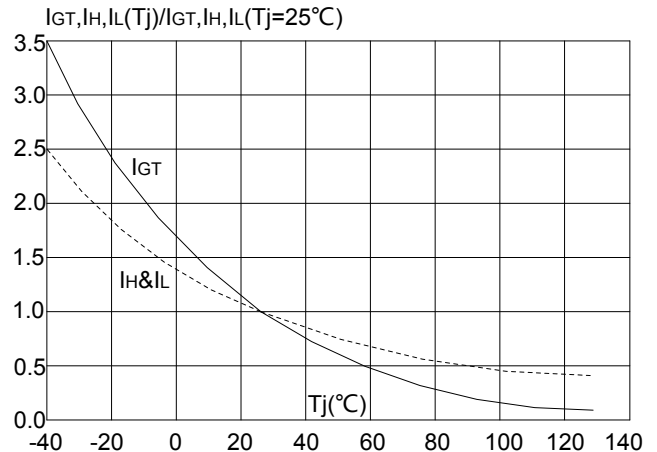

FIG.6: Relative variations of gate trigger current, holding current and latching current versus junction temperature



Technical Data
Data Sheet N2040, Rev.-



DISCLAIMER:

- 1- The information given herein, including the specifications and dimensions, is subject to change without prior notice to improve product characteristics. Before ordering, purchasers are advised to contact the SMC Diode Solutions sales department for the latest version of the datasheet(s).
- 2- In cases where extremely high reliability is required (such as use in nuclear power control, aerospace and aviation, traffic equipment, medical equipment, and safety equipment), safety should be ensured by using semiconductor devices that feature assured safety or by means of users' fail-safe precautions or other arrangement.
- 3- In no event shall SMC Diode Solutions be liable for any damages that may result from an accident or any other cause during operation of the user's units according to the datasheet(s). SMC Diode Solution assumes no responsibility for any intellectual property claims or any other problems that may result from applications of information, products or circuits described in the datasheets.
- 4- In no event shall SMC Diode Solutions be liable for any failure in a semiconductor device or any secondary damage resulting from use at a value exceeding the absolute maximum rating.
- 5- No license is granted by the datasheet(s) under any patents or other rights of any third party or SMC Diode Solutions.
- 6- The datasheet(s) may not be reproduced or duplicated, in any form, in whole or part, without the expressed written permission of SMC Diode Solutions.
- 7- The products (technologies) described in the datasheet(s) are not to be provided to any party whose purpose in their application will hinder maintenance of international peace and safety nor are they to be applied to that purpose by their direct purchasers or any third party. When exporting these products (technologies), the necessary procedures are to be taken in accordance with related laws and regulations..