



Figure similar

Reversing motor starter, Size 2 1/2, Three phase full voltage, Amb. compensate bimetal OLR, Contactor amp rating 60A, 240V 50Hz / 277V 60Hz coil, Non-combination type, Enclosure type 4X fiberglass, Water/dust tight noncorrosive

product brand name	Class 14 & 22
design of the product	Full-voltage reversing motor starter
special product feature	Half-size starter
General technical data	
weight [lb]	18.5 lb
Height x Width x Depth [in]	24 × 15 × 7 in
touch protection against electrical shock	NA for enclosed products
installation altitude [ft] at height above sea level maximum	6560 ft
ambient temperature [°F]	
• during storage	-22 ... +149 °F
• during operation	-4 ... +104 °F
ambient temperature	
• during storage	-30 ... +65 °C
• during operation	-20 ... +40 °C
country of origin	USA
Horsepower ratings	
yielded mechanical performance [hp] for 3-phase AC motor	
• at 200/208 V rated value	15 hp
• at 220/230 V rated value	20 hp
• at 460/480 V rated value	30 hp
• at 575/600 V rated value	30 hp
Contactor	
size of contactor	Controller half size 2 1/2
number of NO contacts for main contacts	3
operating voltage for main current circuit at AC at 60 Hz maximum	600 V
operational current at AC at 600 V rated value	60 A
mechanical service life (switching cycles) of the main contacts typical	10000000
Auxiliary contact	
number of NC contacts at contactor for auxiliary contacts	0
number of NO contacts at contactor for auxiliary contacts	1
number of total auxiliary contacts maximum	7
contact rating of auxiliary contacts of contactor according to UL	10A@600VAC (A600), 5A@600VDC (P600)
Coil	
type of voltage of the control supply voltage	AC
control supply voltage	

<ul style="list-style-type: none"> • at AC at 50 Hz rated value • at AC at 60 Hz rated value 	240 V 277 V
holding power at AC minimum	8.6 W
apparent pick-up power of magnet coil at AC	218 VA
apparent holding power of magnet coil at AC	25 VA
operating range factor control supply voltage rated value of magnet coil	0.85 ... 1.1
percental drop-out voltage of magnet coil related to the input voltage	50 %
ON-delay time	19 ... 29 ms
OFF-delay time	10 ... 24 ms
Overload relay	
product function	
<ul style="list-style-type: none"> • overload protection • test function • external reset 	Yes Yes Yes
reset function	Manual and automatic
adjustment range of thermal overload trip unit	0.85 ... 1.15
number of NC contacts of auxiliary contacts of overload relay	1
number of NO contacts of auxiliary contacts of overload relay	1
operational current of auxiliary contacts of overload relay	
<ul style="list-style-type: none"> • at AC at 600 V • at DC at 250 V 	10 A 5 A
contact rating of auxiliary contacts of overload relay according to UL	10A@600VAC (A600), 5A@250VDC (P300)
Enclosure	
degree of protection NEMA rating	4X, fiber glass
design of the housing	dustproof, waterproof & resistant to corrosion
Mounting/wiring	
mounting position	Vertical
fastening method	Surface mounting and installation
type of electrical connection for supply voltage line-side	Box lug
tightening torque [lbf-in] for supply	45 ... 45 lbf-in
temperature of the conductor for supply maximum permissible	75 °C
material of the conductor for supply	AL or CU
type of electrical connection for load-side outgoing feeder	Screw-type terminals
tightening torque [lbf-in] for load-side outgoing feeder	35 ... 50 lbf-in
type of electrical connection of magnet coil	Screw-type terminals
tightening torque [lbf-in] at magnet coil	5 ... 12 lbf-in
type of connectable conductor cross-sections of magnet coil at AWG cables single or multi-stranded	2x (16 ... 12 AWG)
temperature of the conductor at magnet coil maximum permissible	75 °C
material of the conductor at magnet coil	CU
type of electrical connection for auxiliary contacts	Screw-type terminals
tightening torque [lbf-in] at contactor for auxiliary contacts	10 ... 15 lbf-in
type of connectable conductor cross-sections at contactor at AWG cables for auxiliary contacts single or multi-stranded	1x (12 AWG), 2x (16 ... 14 AWG), 2x (18 ... 16 AWG)
temperature of the conductor at contactor for auxiliary contacts maximum permissible	75 °C
material of the conductor at contactor for auxiliary contacts	CU
type of electrical connection at overload relay for auxiliary contacts	Screw-type terminals
tightening torque [lbf-in] at overload relay for auxiliary contacts	5 ... 12 lbf-in
type of connectable conductor cross-sections at overload relay at AWG cables for auxiliary contacts single or multi-stranded	2x (16 ... 12 AWG)
temperature of the conductor at overload relay for auxiliary	75 °C

contacts maximum permissible	
material of the conductor at overload relay for auxiliary contacts	CU
Short-circuit current rating	
design of the fuse link for short-circuit protection of the main circuit required	10kA@600V (Class H or K); 100kA@600V (Class R or J)
design of the short-circuit trip	Thermal magnetic circuit breaker
breaking capacity maximum short-circuit current (I _{cu})	
<ul style="list-style-type: none"> • at 240 V • at 480 V • at 600 V 	14 kA 10 kA 10 kA
certificate of suitability	NEMA ICS 2; UL 508; CSA 22.2, No.14
Further information	

Industrial Controls - Product Overview (Catalogs, Brochures,...)

www.usa.siemens.com/iccatalog

Industry Mall (Online ordering system)

<https://mall.industry.siemens.com/mall/en/us/Catalog/product?mlfb=US2:22GP32FL91>

Service&Support (Manuals, Certificates, Characteristics, FAQs,...)

<https://support.industry.siemens.com/cs/US/en/ps/US2:22GP32FL91>

Image database (product images, 2D dimension drawings, 3D models, device circuit diagrams, EPLAN macros, ...)

http://www.automation.siemens.com/bilddb/cax_de.aspx?mlfb=US2:22GP32FL91&lang=en

Certificates/approvals

<https://support.industry.siemens.com/cs/US/en/ps/US2:22GP32FL91/certificate>

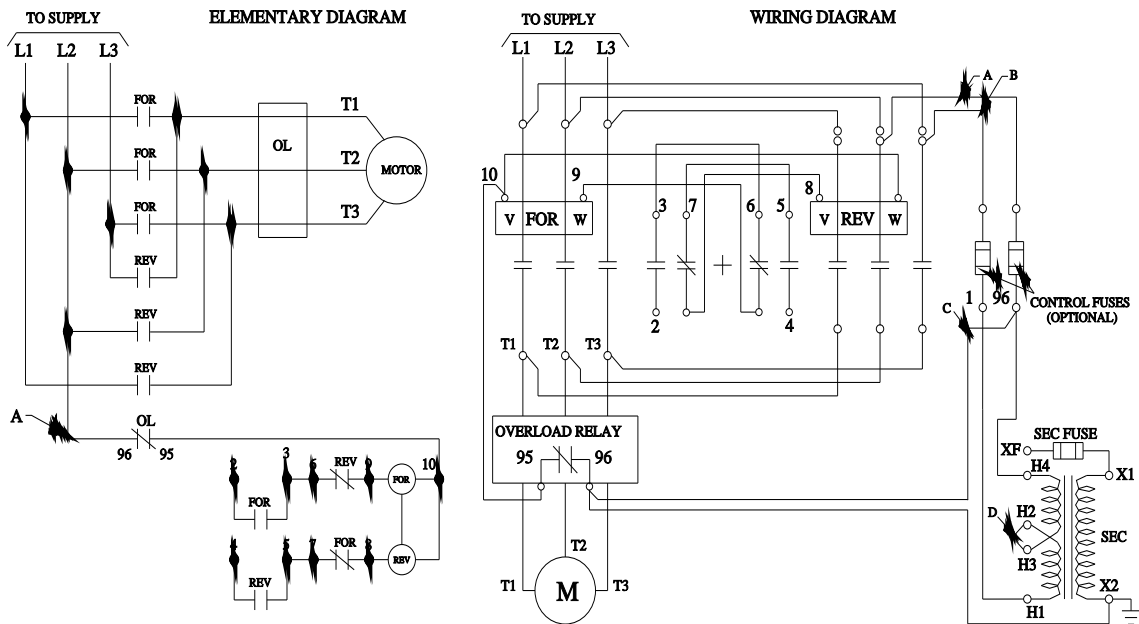

D46590003

last modified:

1/25/2022