

Features

- Low cost 1W converter
- Industry standard pinout
- SIP4 package
- 1kVDC isolation
- Efficiency up to 79%
- Wide operating temperature range -40°C to +85°C
- UL60950-1, CAN/CSA C22.2 No. 60950-1 certified

Unregulated Converters



RFM

**1 Watt
SIP4
Single Output**

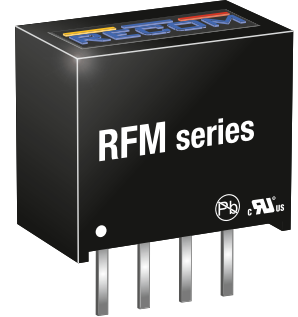

UL60950-1 certified
CAN/CSA-C22.2 No 60950-1 certified
EN55032 compliant

Description

The RFM DC/DC converter is typically used in cost sensitive general purpose power isolation and voltage matching applications. Despite its low cost, it is a fully specified converter with 1kVDC isolation, industrial operating temperature range of -40°C to +85°C without derating and UL/EN certifications.

Selection Guide

Part Number	Input Voltage [VDC]	Output Voltage [VDC]	Output Current [mA]	Efficiency ⁽¹⁾ typ. [%]	Max. Capacitive Load ⁽²⁾ [µF]
RFM-0505S	5	5	200	79	470

Notes:

- Note1: Efficiency is tested at nominal input and full load at +25°C ambient
Note2: Max. Cap Load is tested at nominal input and full resistive load

Model Numbering

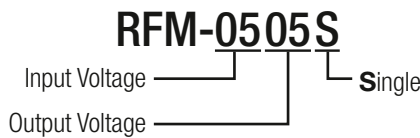

Specifications (measured @ Ta= 25°C, nominal input voltage, full load and after warm-up)

BASIC CHARACTERISTICS				
Parameter	Condition	Min.	Typ.	Max.
Internal Input Filter				capacitor
Input Voltage Range			±10%	
Input Current	max. load		250mA	
Quiescent Current	nom. Vin = 5VDC		25mA	30mA
Minimum Load ⁽³⁾		0%		
Internal Operating Frequency		50kHz	80kHz	100kHz
Output Ripple and Noise ⁽⁴⁾	20MHz BW		50mVp-p	100mVp-p
Reflected Back Ripple Current	20MHz BW, no external choke		20mA _{p-p}	

Notes:

- Note3: Operation below 10% load won't harm the converter, but specifications may not be met
Note4: Measurements are made with a 100nF MLCC across output (low ESR)

continued on next page

Specifications (measured @ Ta= 25°C, nominal input voltage, full load and after warm-up)

Efficiency vs. Load
(nominal Vin= 5VDC)

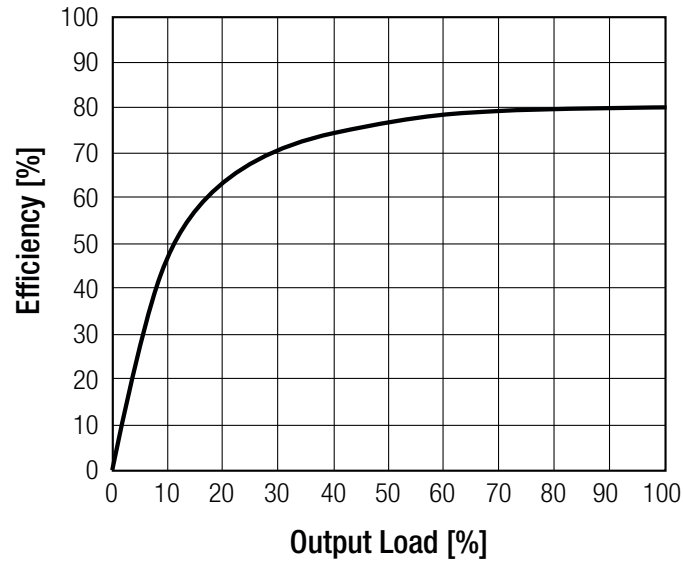

REGULATIONS

Parameter	Condition	Values
Output Accuracy		±5.0% max.
Line Regulation	low line to high line, full load	±1.2% typ. / ±1% max.
Load Regulation	10% to 100%	±10% typ. / ±15% max.

Tolerance Envelope

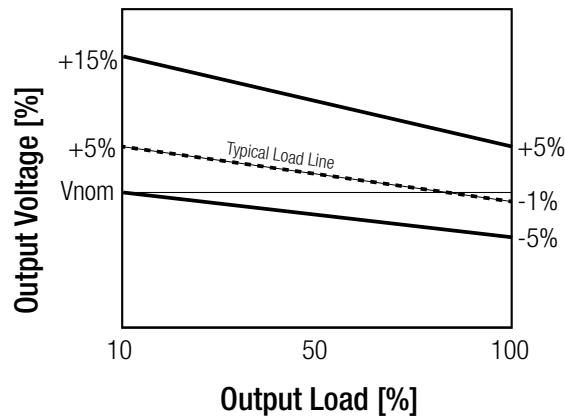

PROTECTIONS

Parameter	Condition	Value
Isolation Voltage ⁽⁵⁾	I/P to O/P tested for 1 second	1KVDC
Isolation Resistance		1GΩ min.
Isolation Capacitance		75pF max.
Leakage Current	500VAC, 50Hz	1μA max.
Insulation Grade		Functional

Notes:

Note5: For repeat Hi-Pot testing, reduce the time and/or the test voltage

Specifications (measured @ Ta= 25°C, nominal input voltage, full load and after warm-up)

ENVIRONMENTAL

Parameter	Condition		Value
Operating Temperature Range	(@ natural convection 0.1m/s) (see graph)	without derating	-40°C to +85°C
Maximum Case Temperature			+105°C
Temperature Coefficient			±0.05%/°C
Thermal Impedance	0.1 m/s, horizontal direction		60°C/W
Operating Altitude			2000m
Operating Humidity	non-condensing		95% RH max.
Pollution Degree			PD2
Vibration			MIL-STD-202G
MTBF	according to MIL-HDBK-217F, G.B.	+25°C +85°C	20100 x 10 ³ hours 8700 x 10 ³ hours

Derating Graph

(@ Chamber and natural convection 0.1m/s)

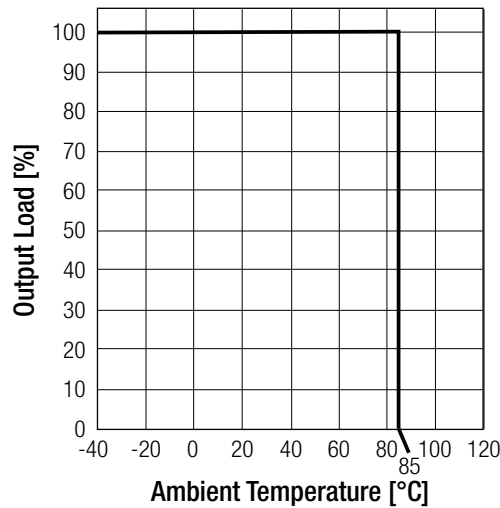

SAFETY AND CERTIFICATIONS

Certificate Type (Safety)	Report/File Number	Standard
Information Technology Equipment, General Requirements for Safety	E358085-A4	UL60950-1, 2nd Edition, 2007
		CSA C22.2 No. 60950-1-07, 2nd Edition, 2007
RoHs 2+		RoHs 10/10, 2015

EMC Compliance	Condition	Standard / Criterion
Information technology equipment - Radio disturbance characteristics - Limits and methods of measurement	with external filter (see below filter suggestion)	EN55032, Class A, B

EMC Filtering - Suggestions for Class A and B

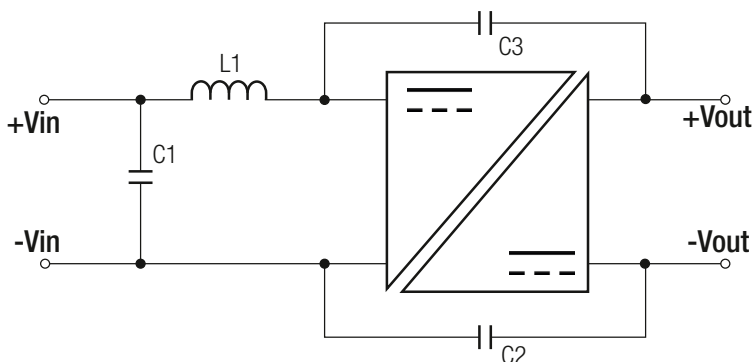

Component List Class A			
C1	L1	C2	C3
6.8µF	-	-	-

Component List Class B		
C1	L1	C2 and C3
10µF	22µH	330pF/1kV

Specifications (measured @ Ta= 25°C, nominal input voltage, full load and after warm-up)

DIMENSION AND PHYSICAL CHARACTERISTICS

Parameter	Type	Value
Material	case potting	non-conductive black plastic (UL94 V-0) epoxy (UL94 V-2)
Package Dimension (LxWxH)		11.5 x 6.0 x 10.0mm
Package Weight		1.4g

Dimension Drawing (mm)

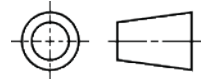
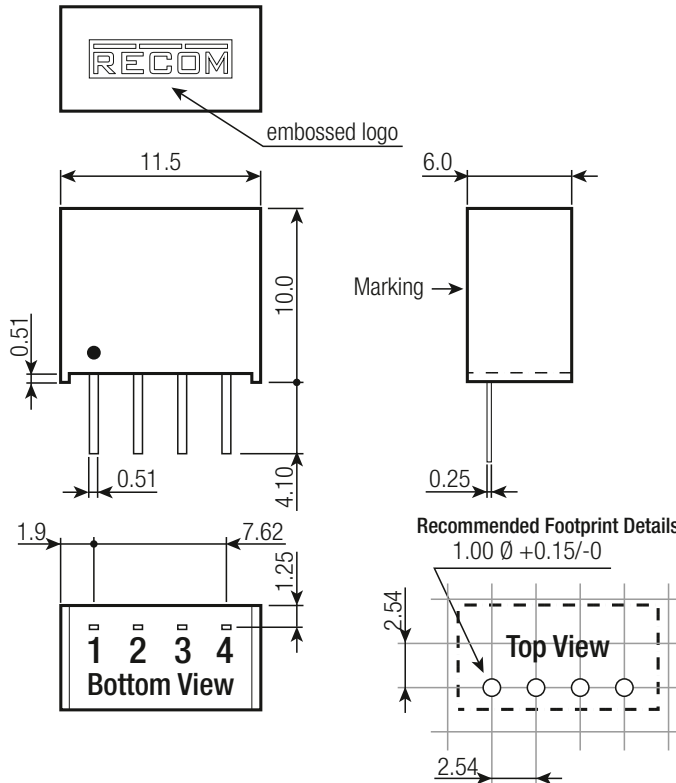

Pin Connections

Pin #	Function
1	-Vin
2	+Vin
3	-Vout
4	+Vout

Tolerance: xx.x= ±0.5mm
xx.xx= ±0.25mm

Pin tolerance:
Thickness: ±0.05mm
Length: +0.25/-0.50mm

PACKAGING INFORMATION

Parameter	Type	Value
Packaging Dimension (LxWxH)	tube	520.0 x 16.0 x 9.0mm
Packaging Quantity		42pcs
Storage Temperature Range		-55°C to +125°C
Storage Humidity		5% - 95%, RH

The product information and specifications may be subject to changes even without prior written notice. The product has been designed for various applications; its suitability lies in the responsibility of each customer. The products are not authorized for use in safety-critical applications without RECOM's explicit written consent. A safety-critical application is an application where a failure may reasonably be expected to endanger or cause loss of life, inflict bodily harm or damage property. The applicant shall indemnify and hold harmless RECOM, its affiliated companies and its representatives against any damage claims in connection with the unauthorized use of RECOM products in such safety-critical applications.