

Fast IGBT in NPT-technology

- 75% lower E_{off} compared to previous generation combined with low conduction losses
- Short circuit withstand time – 10 μ s
- Designed for:
 - Motor controls
 - Inverter
- NPT-Technology for 600V applications offers:
 - very tight parameter distribution
 - high ruggedness, temperature stable behaviour
 - parallel switching capability

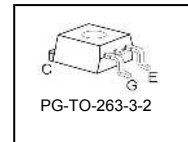
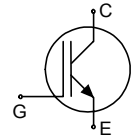

- Qualified according to JEDEC¹ for target applications
- Pb-free lead plating; RoHS compliant

- Complete product spectrum and PSpice Models : <http://www.infineon.com/igbt/>

Type	V_{CE}	I_C	$V_{CE(sat)}$	T_j	Marking	Package
SGB15N60	600V	15A	2.3V	150°C	G15N60	PG-TO-263-3-2

Maximum Ratings

Parameter	Symbol	Value	Unit
Collector-emitter voltage	V_{CE}	600	V
DC collector current	I_C	31	A
$T_C = 25^\circ\text{C}$		15	
$T_C = 100^\circ\text{C}$			
Pulsed collector current, t_p limited by T_{jmax}	I_{Cpuls}	62	
Turn off safe operating area	-	62	
$V_{CE} \leq 600\text{V}, T_j \leq 150^\circ\text{C}$			
Gate-emitter voltage	V_{GE}	± 20	V
Avalanche energy, single pulse	E_{AS}	85	mJ
$I_C = 15\text{ A}, V_{CC} = 50\text{ V}, R_{GE} = 25\ \Omega,$ start at $T_j = 25^\circ\text{C}$			
Short circuit withstand time ²	t_{SC}	10	μ s
$V_{GE} = 15\text{V}, V_{CC} \leq 600\text{V}, T_j \leq 150^\circ\text{C}$			
Power dissipation	P_{tot}	139	W
$T_C = 25^\circ\text{C}$			
Operating junction and storage temperature	T_j, T_{stg}	-55...+150	$^\circ\text{C}$
Soldering temperature (reflow soldering, MSL1)		245	

¹ J-STD-020 and JESD-022

² Allowed number of short circuits: <1000; time between short circuits: >1s.

Thermal Resistance

Parameter	Symbol	Conditions	Max. Value	Unit
Characteristic				
IGBT thermal resistance, junction – case	R_{thJC}		0.9	K/W
Thermal resistance, junction – ambient ¹⁾	R_{thJA}		40	

Electrical Characteristic, at $T_j = 25\text{ }^\circ\text{C}$, unless otherwise specified

Parameter	Symbol	Conditions	Value			Unit	
			min.	Typ.	max.		
Static Characteristic							
Collector-emitter breakdown voltage	$V_{(BR)CES}$	$V_{GE}=0V, I_C=500\mu A$	600	-	-	V	
Collector-emitter saturation voltage	$V_{CE(sat)}$	$V_{GE} = 15V, I_C=15A$	1.7	2	2.4		
		$T_j=150^\circ C$	-	2.3	2.8		
Gate-emitter threshold voltage	$V_{GE(th)}$	$I_C=400\mu A, V_{CE}=V_{GE}$	3	4	5		
Zero gate voltage collector current	I_{CES}	$V_{CE}=600V, V_{GE}=0V$	$T_j=25^\circ C$	-	-	40	μA
			$T_j=150^\circ C$	-	-	2000	
Gate-emitter leakage current	I_{GES}	$V_{CE}=0V, V_{GE}=20V$	-	-	100	nA	
Transconductance	g_{fs}	$V_{CE}=20V, I_C=15A$	3	10.9	-	S	
Dynamic Characteristic							
Input capacitance	C_{iss}	$V_{CE}=25V,$ $V_{GE}=0V,$ $f=1MHz$	-	800	960	pF	
Output capacitance	C_{oss}		-	84	101		
Reverse transfer capacitance	C_{riss}		-	52	62		
Gate charge	Q_{Gate}	$V_{CC}=480V, I_C=15A$ $V_{GE}=15V$	-	76	99	nC	
Internal emitter inductance measured 5mm (0.197 in.) from case	L_E		-	7	-	nH	
Short circuit collector current ²⁾	$I_{C(SC)}$	$V_{GE}=15V, t_{SC}\leq 10\mu s$ $V_{CC}\leq 600V,$ $T_j\leq 150^\circ C$	-	150	-	A	

¹⁾ Device on 50mm*50mm*1.5mm epoxy PCB FR4 with 6cm² (one layer, 70μm thick) copper area for collector connection. PCB is vertical without blown air.

²⁾ Allowed number of short circuits: <1000; time between short circuits: >1s.

Switching Characteristic, Inductive Load, at $T_j=25^\circ\text{C}$

Parameter	Symbol	Conditions	Value			Unit
			min.	typ.	max.	
IGBT Characteristic						
Turn-on delay time	$t_{d(\text{on})}$	$T_j=25^\circ\text{C}$, $V_{CC}=400\text{V}$, $I_C=15\text{A}$, $V_{GE}=0/15\text{V}$, $R_G=21\Omega$, $L_{\sigma}^{1)}=180\text{nH}$, $C_{\sigma}^{1)}=250\text{pF}$ Energy losses include "tail" and diode reverse recovery.	-	32	38	ns
Rise time	t_r		-	23	28	
Turn-off delay time	$t_{d(\text{off})}$		-	234	281	
Fall time	t_f		-	46	55	
Turn-on energy	E_{on}		-	0.30	0.36	mJ
Turn-off energy	E_{off}		-	0.27	0.35	
Total switching energy	E_{ts}		-	0.57	0.71	

Switching Characteristic, Inductive Load, at $T_j=150^\circ\text{C}$

Parameter	Symbol	Conditions	Value			Unit
			min.	typ.	max.	
IGBT Characteristic						
Turn-on delay time	$t_{d(\text{on})}$	$T_j=150^\circ\text{C}$ $V_{CC}=400\text{V}$, $I_C=15\text{A}$, $L_{\sigma}^{1)}=180\text{nH}$, $C_{\sigma}^{1)}=250\text{pF}$ $V_{GE}=0/15\text{V}$, $R_G=21\Omega$ Energy losses include "tail" and diode reverse recovery.	-	31	38	ns
Rise time	t_r		-	23	28	
Turn-off delay time	$t_{d(\text{off})}$		-	261	313	
Fall time	t_f		-	54	65	
Turn-on energy	E_{on}		-	0.45	0.54	mJ
Turn-off energy	E_{off}		-	0.41	0.53	
Total switching energy	E_{ts}		-	0.86	1.07	

¹⁾ Leakage inductance L_{σ} and Stray capacity C_{σ} due to dynamic test circuit in Figure E.

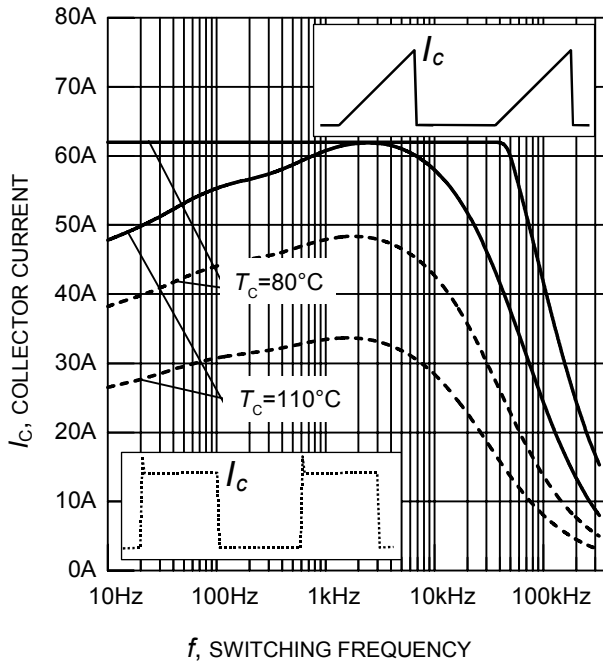

Figure 1. Collector current as a function of switching frequency
 ($T_j \leq 150^\circ\text{C}$, $D = 0.5$, $V_{CE} = 400\text{V}$, $V_{GE} = 0/+15\text{V}$, $R_G = 21\Omega$)

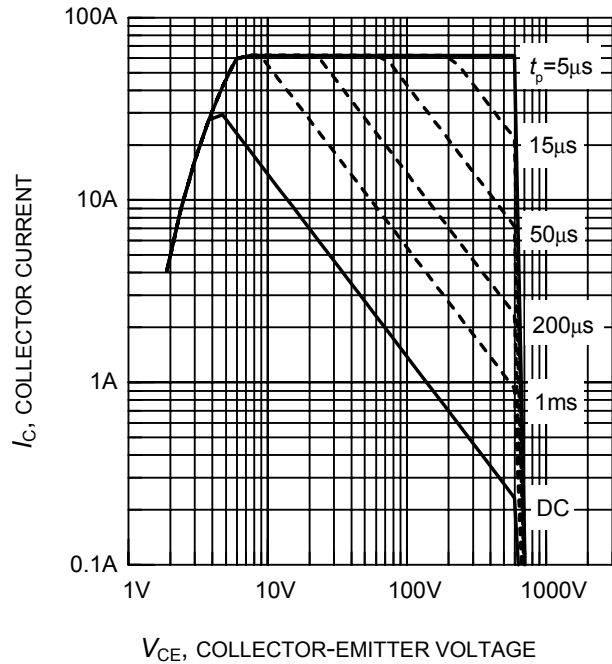

Figure 2. Safe operating area
 ($D = 0$, $T_C = 25^\circ\text{C}$, $T_j \leq 150^\circ\text{C}$)

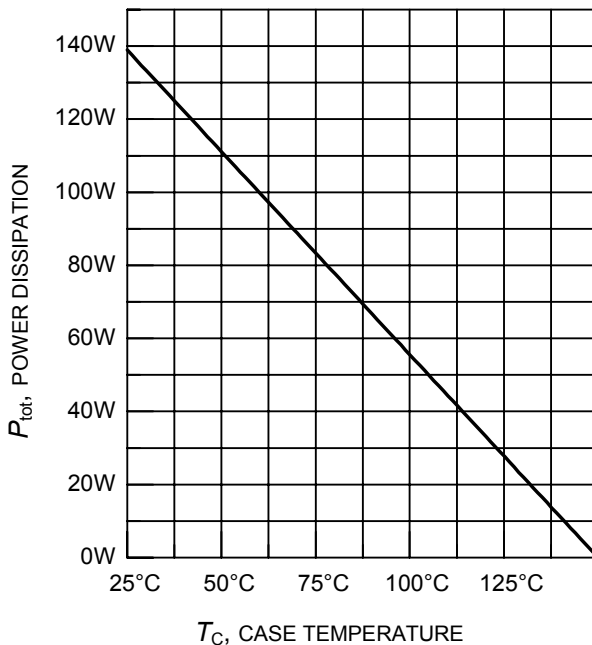

Figure 3. Power dissipation as a function of case temperature
 ($T_j \leq 150^\circ\text{C}$)

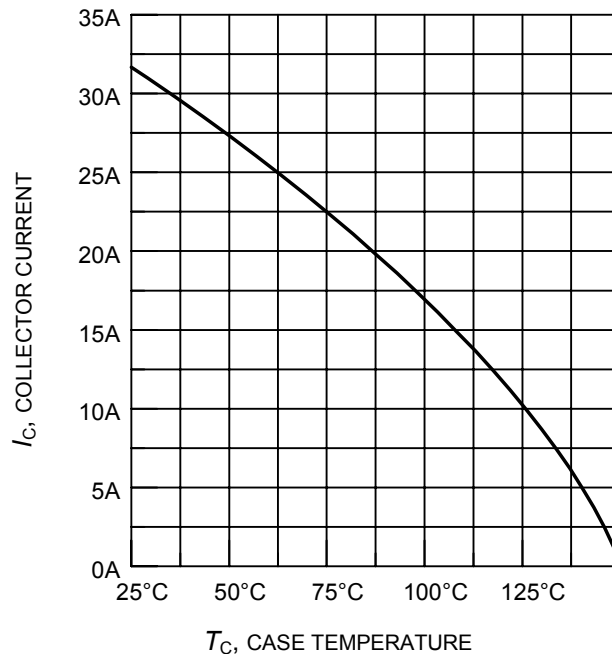

Figure 4. Collector current as a function of case temperature
 ($V_{GE} \leq 15\text{V}$, $T_j \leq 150^\circ\text{C}$)

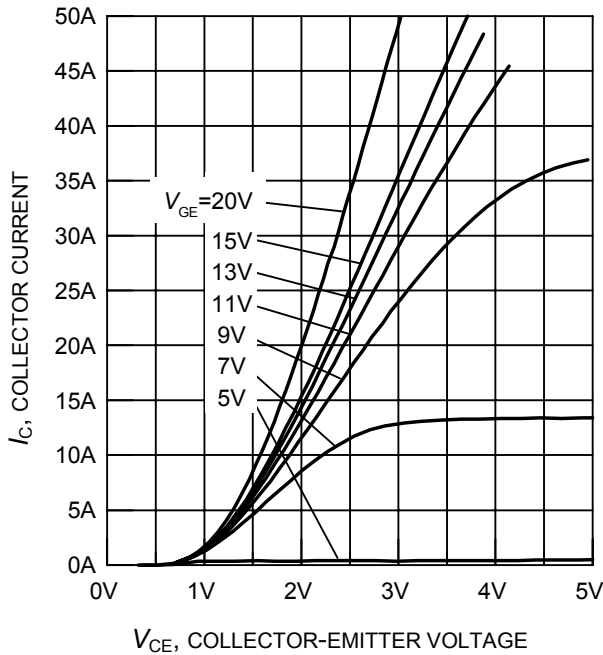

Figure 5. Typical output characteristics
($T_j = 25^\circ\text{C}$)

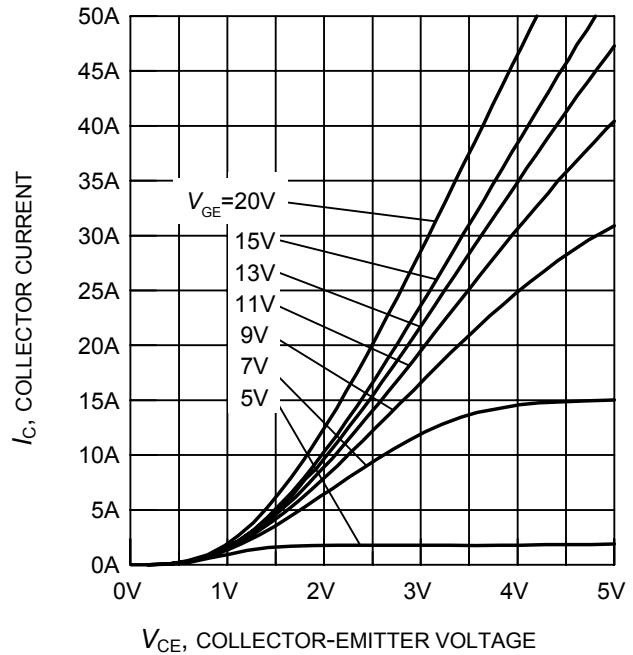

Figure 6. Typical output characteristics
($T_j = 150^\circ\text{C}$)

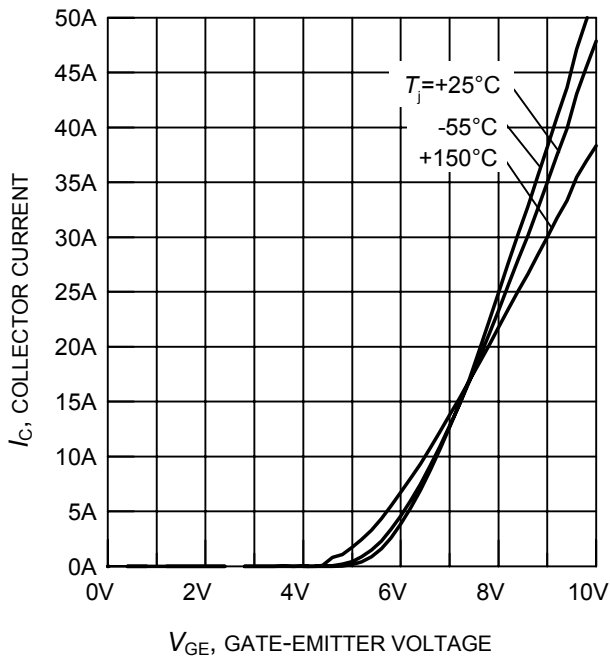

Figure 7. Typical transfer characteristics
($V_{CE} = 10\text{V}$)

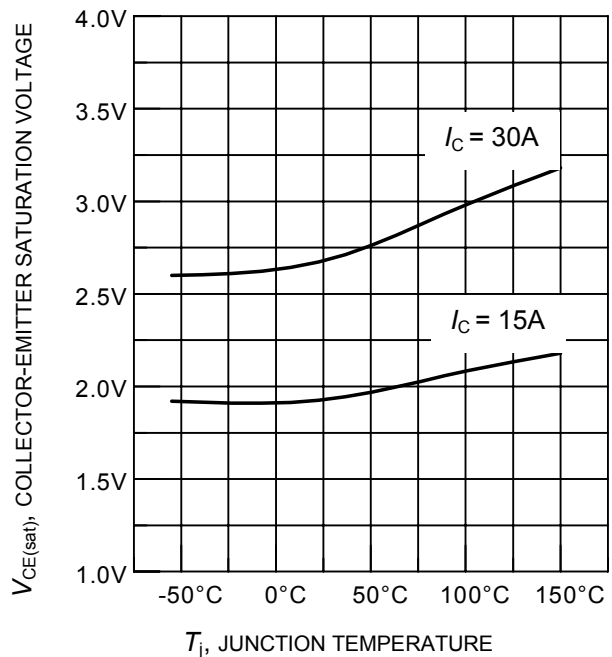

Figure 8. Typical collector-emitter saturation voltage as a function of junction temperature
($V_{GE} = 15\text{V}$)

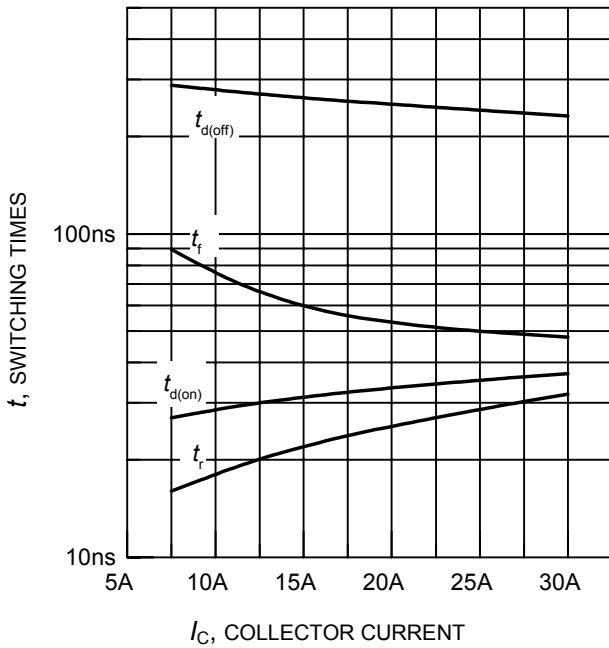

Figure 9. Typical switching times as a function of collector current
 (inductive load, $T_j = 150^\circ\text{C}$, $V_{CE} = 400\text{V}$,
 $V_{GE} = 0/+15\text{V}$, $R_G = 21\Omega$,
 Dynamic test circuit in Figure E)

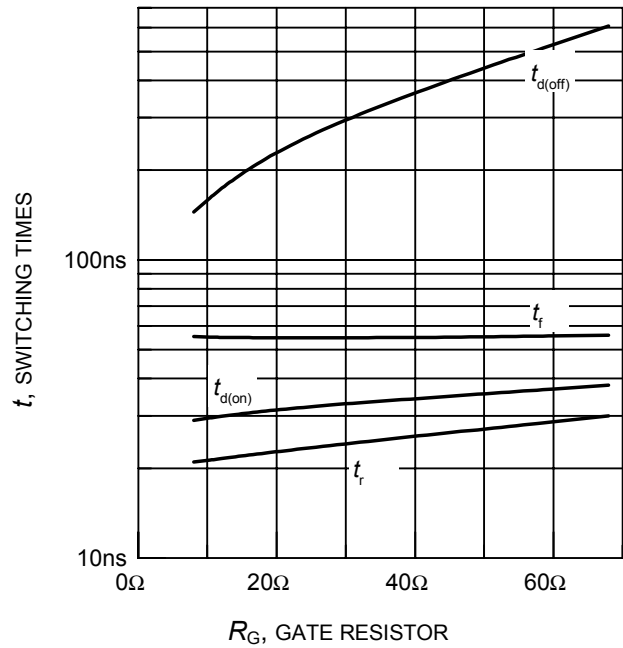

Figure 10. Typical switching times as a function of gate resistor
 (inductive load, $T_j = 150^\circ\text{C}$, $V_{CE} = 400\text{V}$,
 $V_{GE} = 0/+15\text{V}$, $I_C = 15\text{A}$,
 Dynamic test circuit in Figure E)

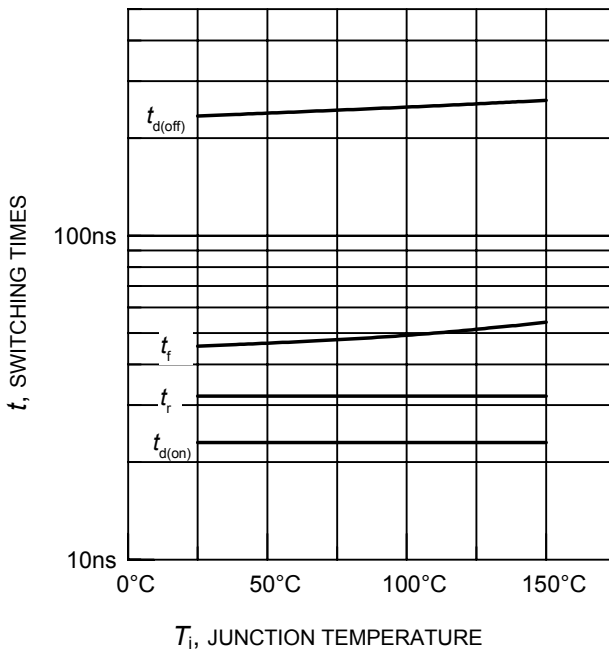

Figure 11. Typical switching times as a function of junction temperature
 (inductive load, $V_{CE} = 400\text{V}$, $V_{GE} = 0/+15\text{V}$,
 $I_C = 15\text{A}$, $R_G = 21\Omega$,
 Dynamic test circuit in Figure E)

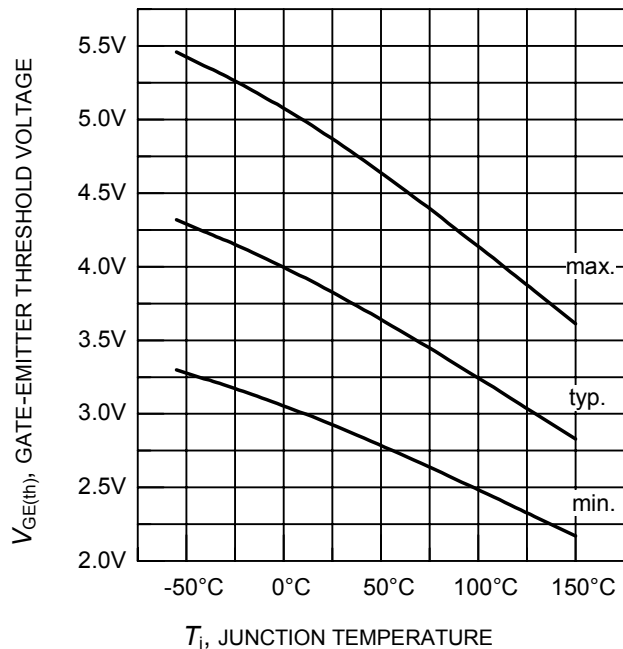

Figure 12. Gate-emitter threshold voltage as a function of junction temperature
 ($I_C = 0.4\text{mA}$)

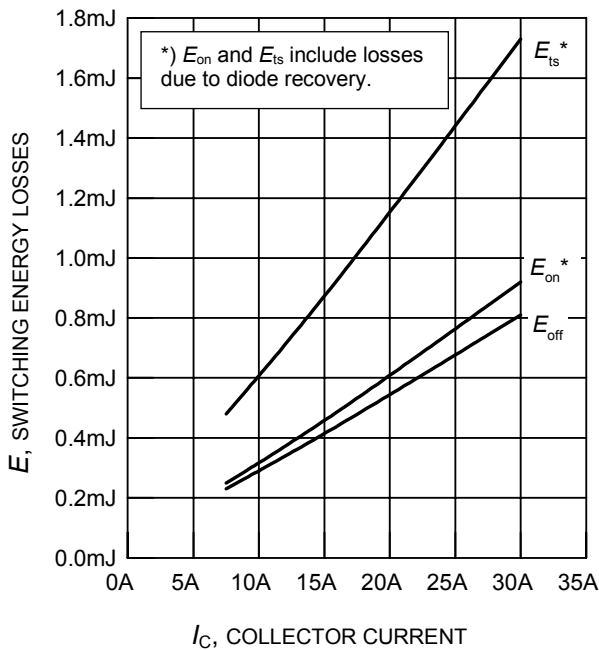

Figure 13. Typical switching energy losses as a function of collector current
 (inductive load, $T_j = 150^\circ\text{C}$, $V_{CE} = 400\text{V}$, $V_{GE} = 0/+15\text{V}$, $R_G = 21\Omega$,
 Dynamic test circuit in Figure E)

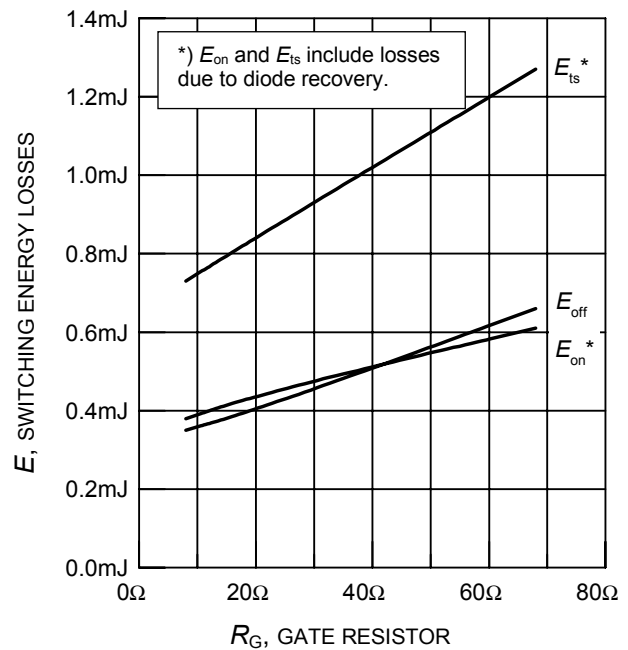

Figure 14. Typical switching energy losses as a function of gate resistor
 (inductive load, $T_j = 150^\circ\text{C}$, $V_{CE} = 400\text{V}$, $V_{GE} = 0/+15\text{V}$, $I_C = 15\text{A}$,
 Dynamic test circuit in Figure E)

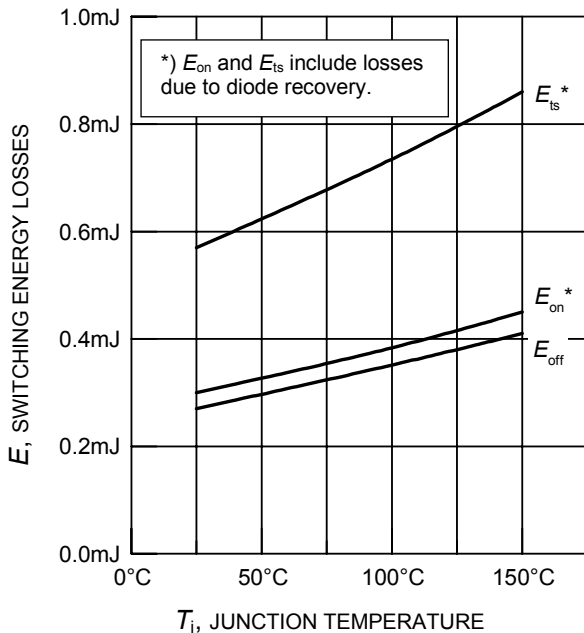

Figure 15. Typical switching energy losses as a function of junction temperature
 (inductive load, $V_{CE} = 400\text{V}$, $V_{GE} = 0/+15\text{V}$, $I_C = 15\text{A}$, $R_G = 21\Omega$,
 Dynamic test circuit in Figure E)

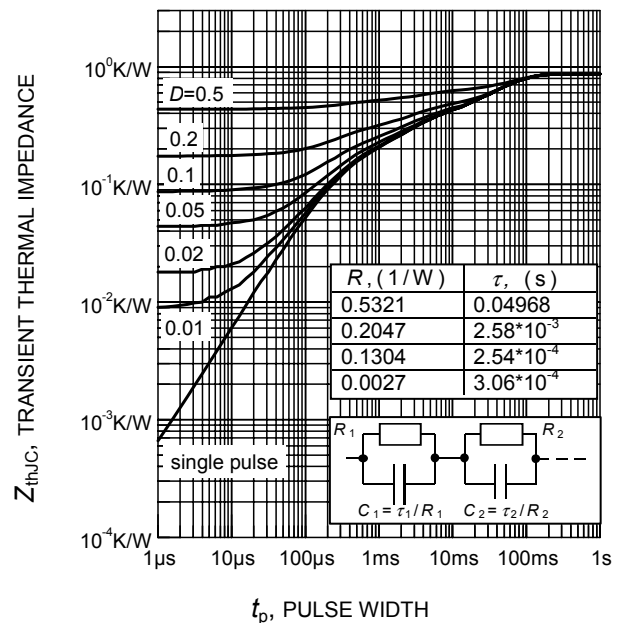

Figure 16. IGBT transient thermal impedance as a function of pulse width
 ($D = t_p / T$)

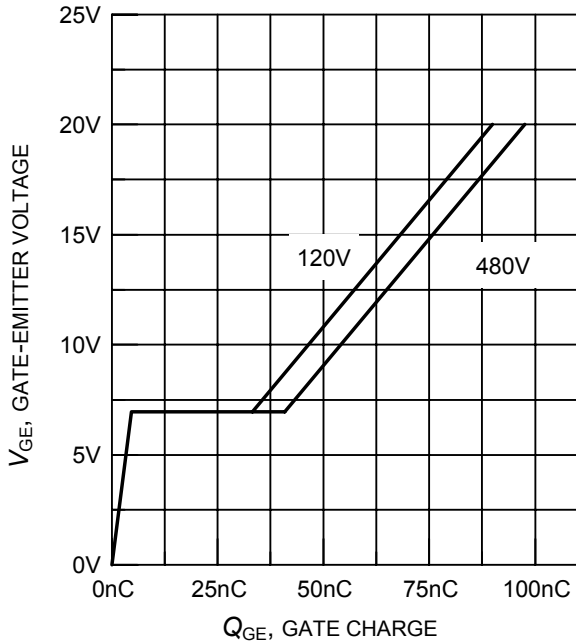

Figure 17. Typical gate charge
($I_C = 15A$)

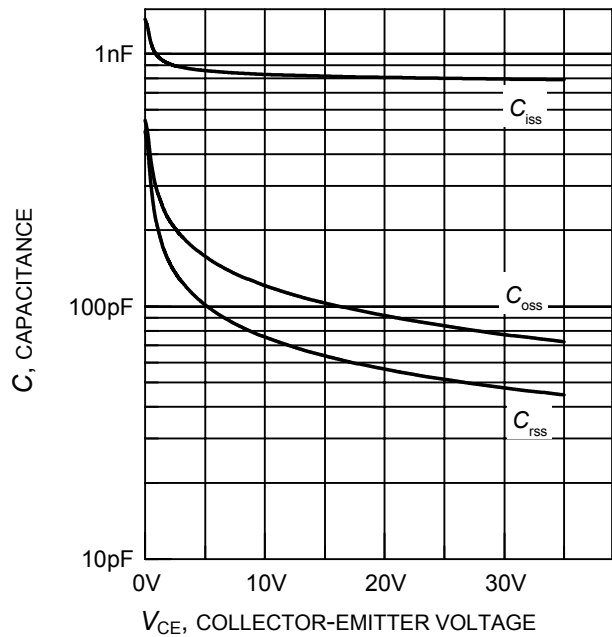

Figure 18. Typical capacitance as a function of collector-emitter voltage
($V_{GE} = 0V, f = 1MHz$)

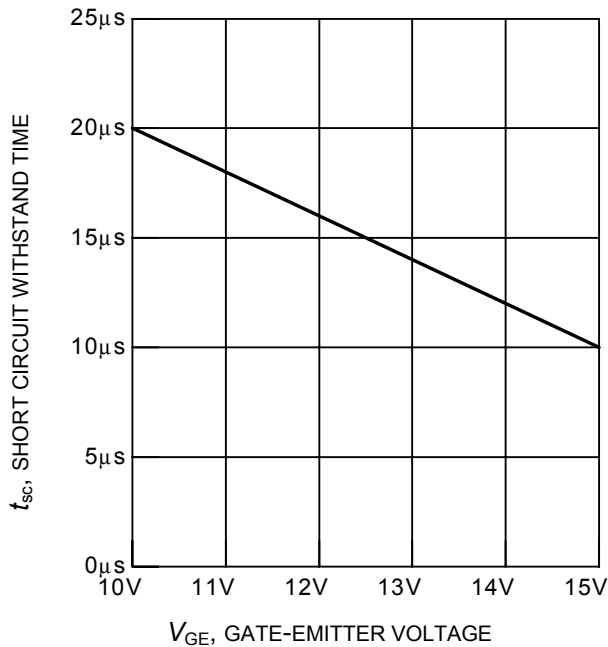

Figure 19. Short circuit withstand time as a function of gate-emitter voltage
($V_{CE} = 600V, \text{start at } T_j = 25^\circ C$)

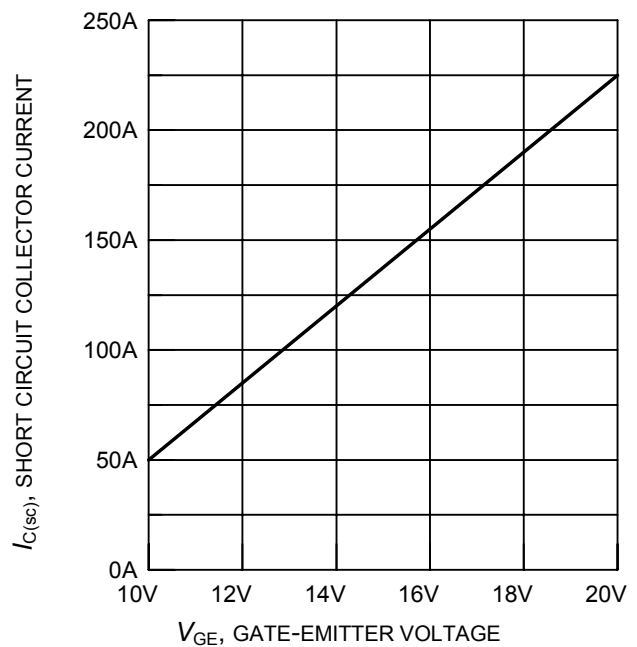
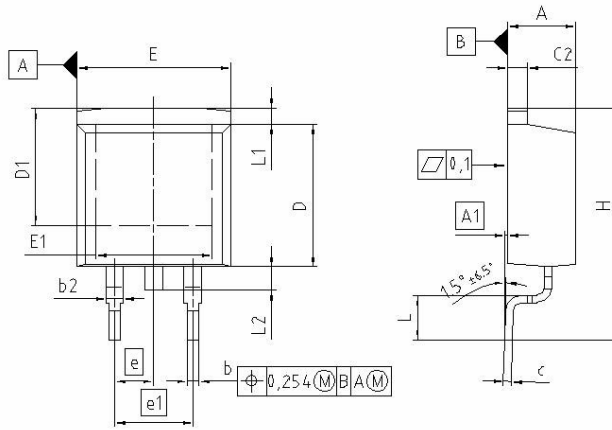
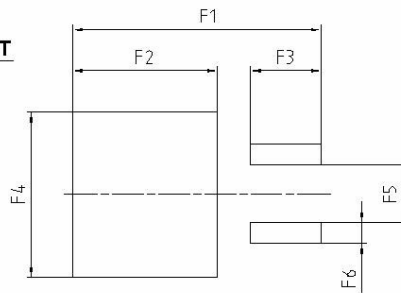

Figure 20. Typical short circuit collector current as a function of gate-emitter voltage
($V_{CE} \leq 600V, T_j = 150^\circ C$)

PG-TO263-3-2



FOOTPRINT



DIM	MILLIMETERS		INCHES	
	MIN	MAX	MIN	MAX
A	4.300	4.572	0.169	0.180
A1	0.000	0.254	0.000	0.010
b	0.850	0.850	0.026	0.033
b2	0.950	1.321	0.037	0.052
c	0.330	0.850	0.013	0.026
c2	0.170	1.400	0.046	0.055
D	8.509	9.450	0.335	0.372
D1	7.100	-	0.280	-
E	9.800	10.312	0.386	0.406
E1	6.500	-	0.256	-
e	2.540		0.100	
e1	5.080		0.200	
N	2		2	
H	14.605	15.875	0.575	0.625
L	2.200	3.000	0.087	0.118
L1	-	1.600	-	0.063
L2	1.000	1.778	0.039	0.070
F1	16.050	16.250	0.632	0.640
F2	9.300	9.500	0.366	0.374
F3	4.500	4.700	0.177	0.185
F4	10.700	10.900	0.421	0.429
F5	3.630	3.830	0.143	0.151
F6	1.100	1.300	0.043	0.051

REFERENCE
JEDEC TO263

SCALE
0 5 5 7.5mm

EUROPEAN PROJECTION

ISSUE DATE
12-02-2006

FILE
TO263_2

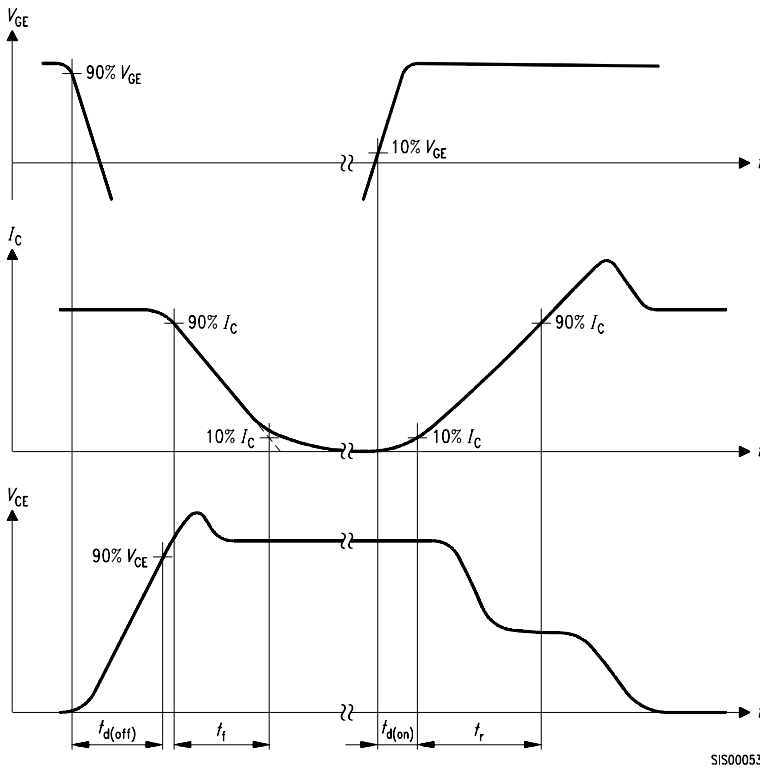

Figure A. Definition of switching times

SIS00053

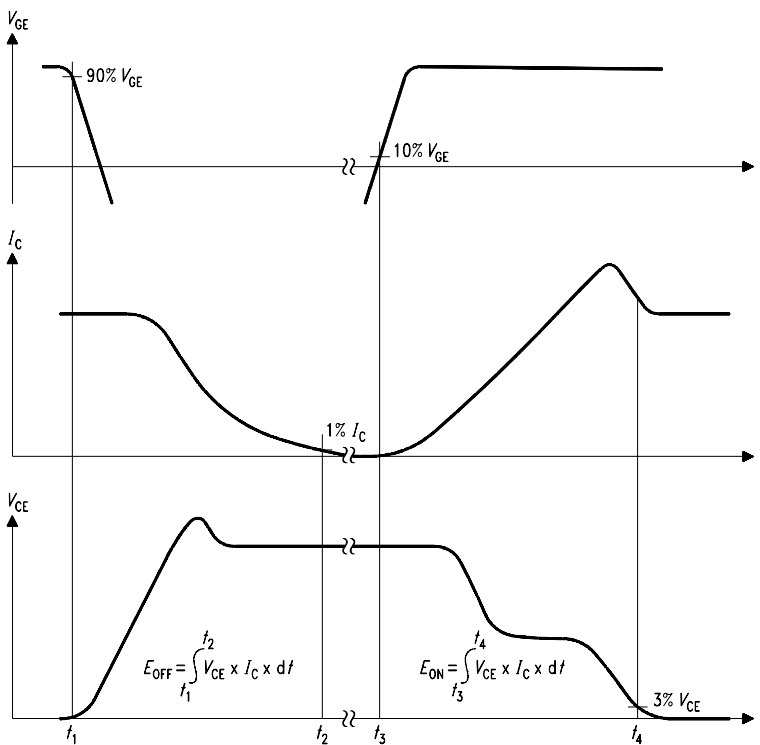

Figure B. Definition of switching losses

SIS00050

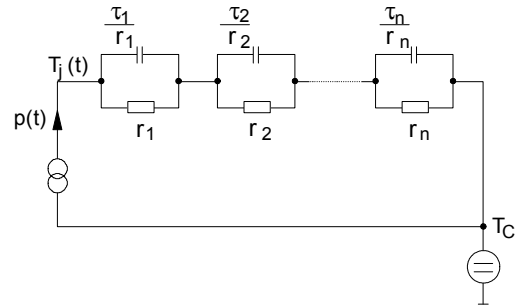

Figure D. Thermal equivalent circuit

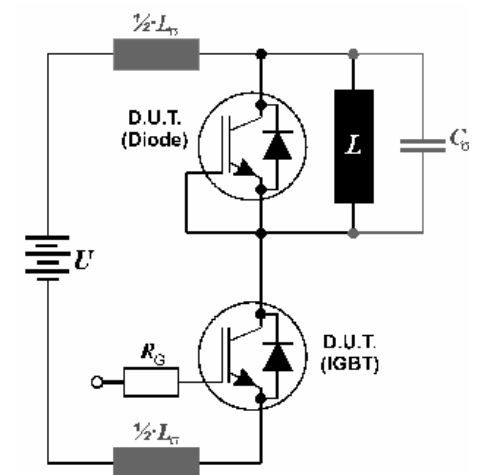

Figure E. Dynamic test circuit
Leakage inductance $L_{\sigma} = 180\text{nH}$
and Stray capacity $C_{\sigma} = 250\text{pF}$.

Edition 2006-01

**Published by
Infineon Technologies AG
81726 München, Germany**

**© Infineon Technologies AG 11/30/06.
All Rights Reserved.**

Attention please!

The information given in this data sheet shall in no event be regarded as a guarantee of conditions or characteristics ("Beschaffheitsgarantie"). With respect to any examples or hints given herein, any typical values stated herein and/or any information regarding the application of the device, Infineon Technologies hereby disclaims any and all warranties and liabilities of any kind, including without limitation warranties of non-infringement of intellectual property rights of any third party.

Information

For further information on technology, delivery terms and conditions and prices please contact your nearest Infineon Technologies Office (www.infineon.com).

Warnings

Due to technical requirements components may contain dangerous substances. For information on the types in question please contact your nearest Infineon Technologies Office.

Infineon Technologies Components may only be used in life-support devices or systems with the express written approval of Infineon Technologies, if a failure of such components can reasonably be expected to cause the failure of that life-support device or system, or to affect the safety or effectiveness of that device or system. Life support devices or systems are intended to be implanted in the human body, or to support and/or maintain and sustain and/or protect human life. If they fail, it is reasonable to assume that the health of the user or other persons may be endangered.