

1-206852-1 ✓ ACTIVE

AMP | AMP CPC

TE Internal #: 1-206852-1

Circular Power Connectors, Connector Assembly, 250 VDC, Wire-to-Board, 9 Position, Printed Circuit Board, Receptacle, Pin, Signal, Black, AMP CPC

[View on TE.com >](#)



Connectors > Power Connectors > Circular Power > Circular Power Connectors > Connectors, CPC Series 2, with Posted Contacts



Connector Product Type: **Connector Assembly**

Operating Voltage: **250 VDC**

Connector System: **Wire-to-Board**

Number of Positions: **9**

Sealable: **No**

[All Connectors, CPC Series 2, with Posted Contacts \(8\)](#)

Features

Product Type Features

Connector Product Type	Connector Assembly
Connector System	Wire-to-Board
Sealable	No
Connector & Contact Terminates To	Printed Circuit Board
Connector & Housing Type	Receptacle
Circular Connector Shell Type	All Plastic

Configuration Features

Number of Positions	9
Number of Power Positions	0
Number of Signal Positions	9

Electrical Characteristics

Operating Voltage	250 VAC
-------------------	---------



Contact Features

Reverse Gender	No
Contact Type	Pin
Contact Current Rating (Max)	7.5 A
Contact Protection	With

Termination Features

Termination Method to Printed Circuit Board	Through Hole - Solder
---	-----------------------

Mechanical Attachment

Mating Alignment Type	Keyed
Mating Alignment	With
Panel Mount Feature Type	Flange with Threaded Inserts
Mating Retention Type	Threaded Coupling
Connector Mounting Type	Panel Mount
Mating Retention	With
Panel Mount Feature	With

Housing Features

Housing Color	Black
Housing Material	Thermoplastic
Circular Connector Shell Size	11

Dimensions

Assembly Length	29.26 mm[1.152 in]
-----------------	--------------------

Usage Conditions

Operating Temperature Range	-55 – 105 °C[-67 – 221 °F]
Fluid Resistance	None

Operation/Application

Circuit Application	Signal
Shielded	No

Industry Standards

UL Flammability Rating	UL 94V-0
------------------------	----------

Packaging Features

Packaging Quantity	27
Packaging Method	Bag



Product Compliance

[For compliance documentation, visit the product page on TE.com>](#)

EU RoHS Directive 2011/65/EU	Compliant
EU ELV Directive 2000/53/EC	Compliant
China RoHS 2 Directive MIIT Order No 32, 2016	No Restricted Materials Above Threshold
EU REACH Regulation (EC) No. 1907/2006	Current ECHA Candidate List: JUNE 2023 (235) Candidate List Declared Against: JUNE 2023 (235) Does not contain REACH SVHC
Halogen Content	BFR/CFR/PVC Free, but Br/Cl >900 ppm in other sources.
Solder Process Capability	Wave solder capable to 265°C

Product Compliance Disclaimer

This information is provided based on reasonable inquiry of our suppliers and represents our current actual knowledge based on the information they provided. This information is subject to change. The part numbers that TE has identified as EU RoHS compliant have a maximum concentration of 0.1% by weight in homogenous materials for lead, hexavalent chromium, mercury, PBB, PBDE, DBP, BBP, DEHP, DIBP, and 0.01% for cadmium, or qualify for an exemption to these limits as defined in the Annexes of Directive 2011/65/EU (RoHS2). Finished electrical and electronic equipment products will be CE marked as required by Directive 2011/65/EU. Components may not be CE marked. Additionally, the part numbers that TE has identified as EU ELV compliant have a maximum concentration of 0.1% by weight in homogenous materials for lead, hexavalent chromium, and mercury, and 0.01% for cadmium, or qualify for an exemption to these limits as defined in the Annexes of Directive 2000/53/EC (ELV). Regarding the REACH Regulation, the information TE provides on SVHC in articles for this part number is based on the latest European Chemicals Agency (ECHA) 'Guidance on requirements for substances in articles' posted at this URL: <https://echa.europa.eu/guidance-documents/guidance-on-reach>

Compatible Parts

			
<p>TE Part # CAT-AM71-C83998B CPC Cable Clamps</p>	<p>TE Part # 206485-1 CPC PLUG ASSEMBLY SIZE 11-9</p>	<p>TE Part # 207489-1 FLEXIBLE CABLE BOOT, SIZE 11</p>	<p>TE Part # 207490-1 CABLE GRIPPER, SIZE 11</p>



Also in the Series | AMP CPC

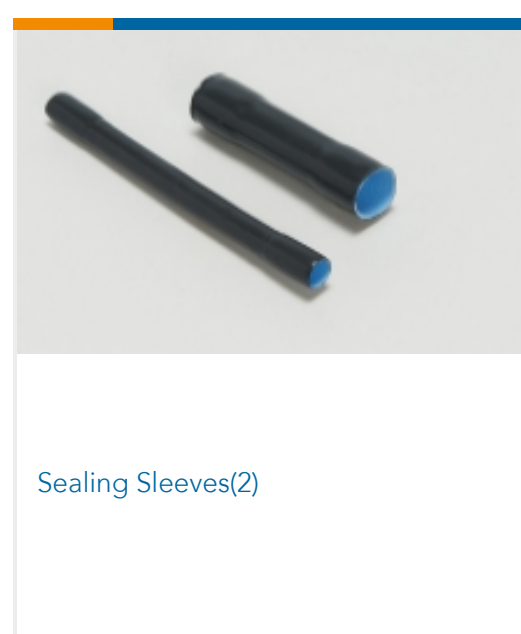
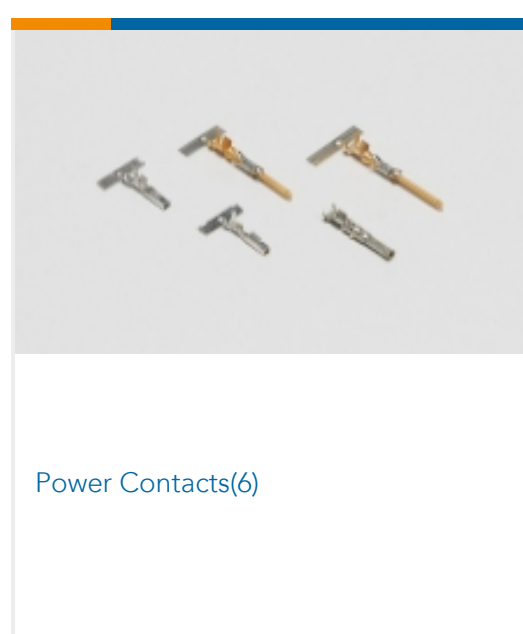
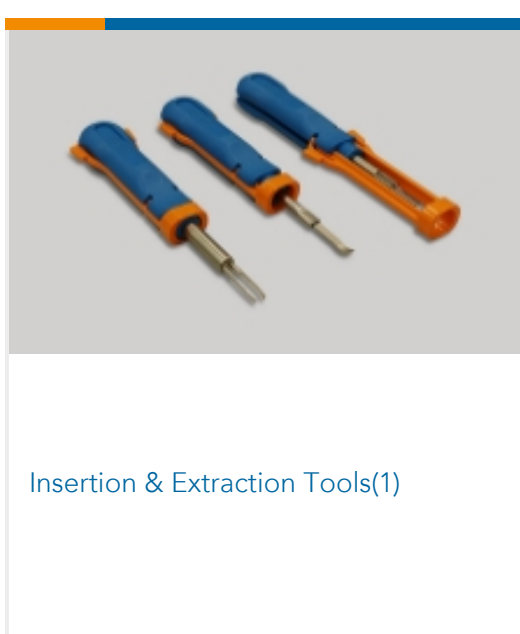
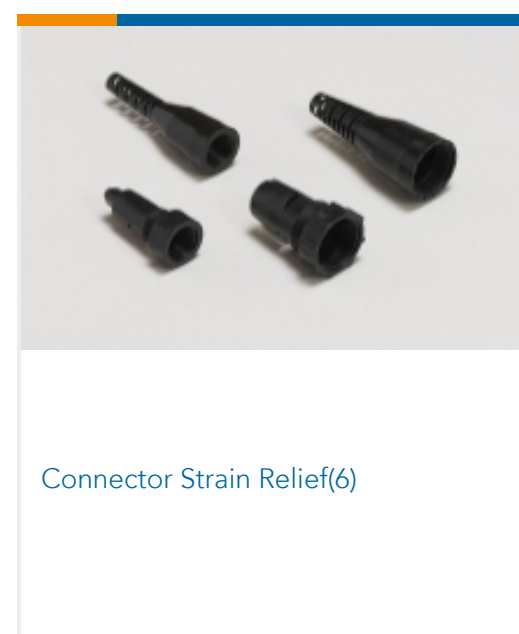
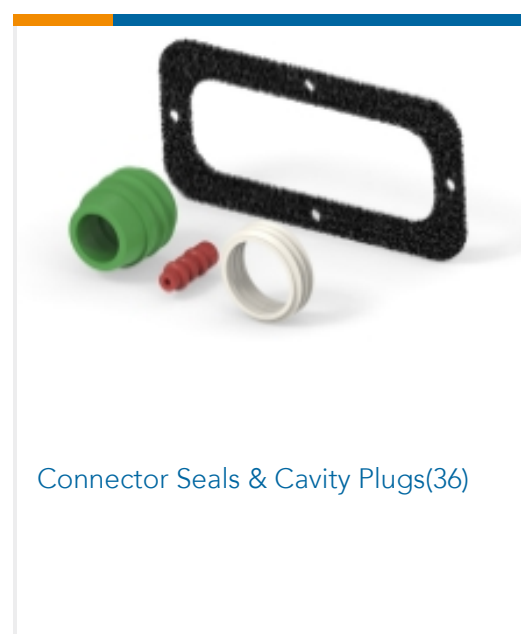
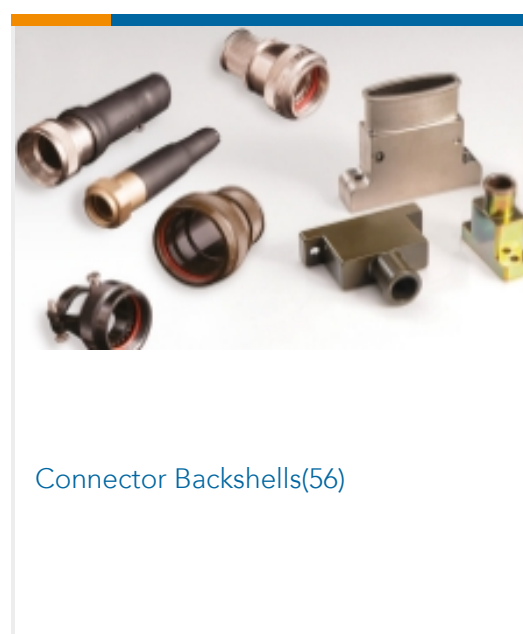
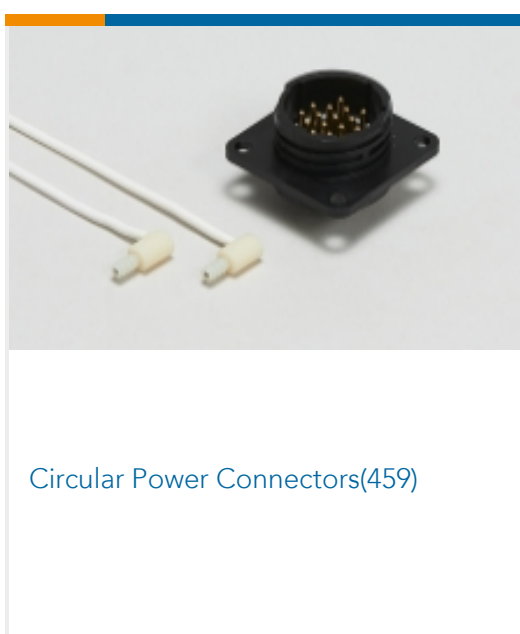
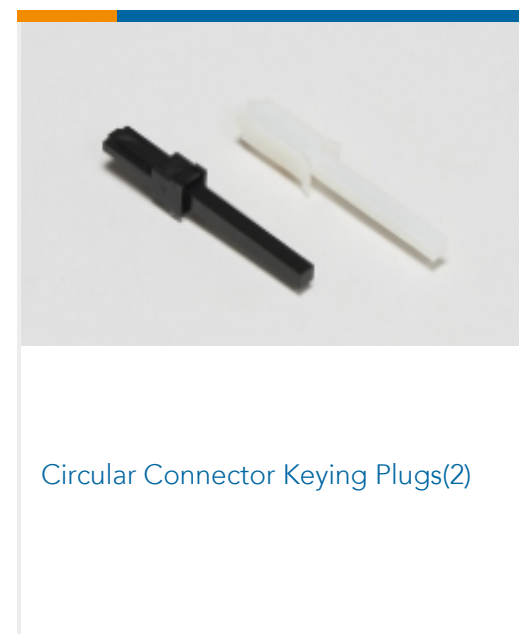
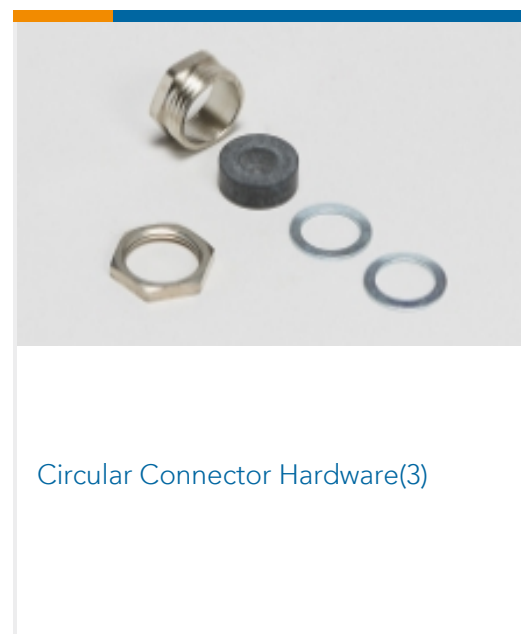
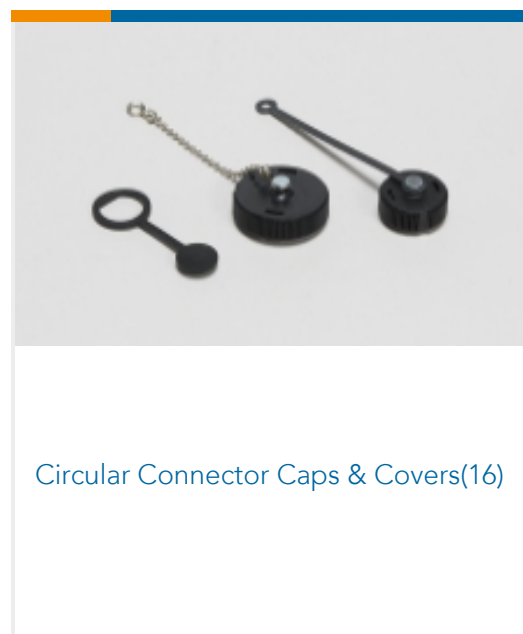
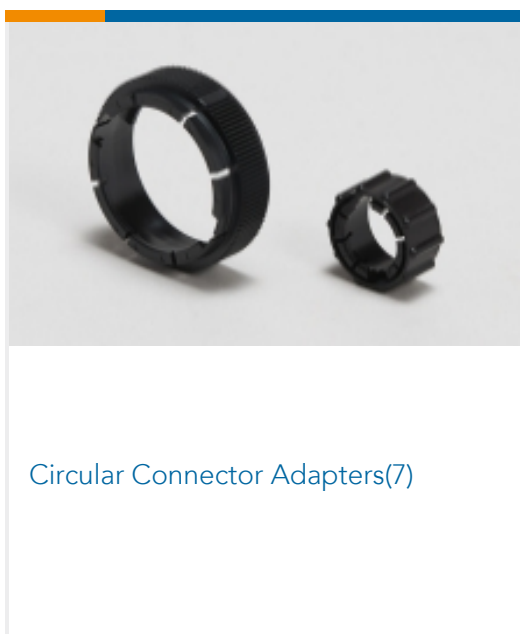

Customers Also Bought



TE Part #5745967-8
25 RCPT SP/FMS INSRT

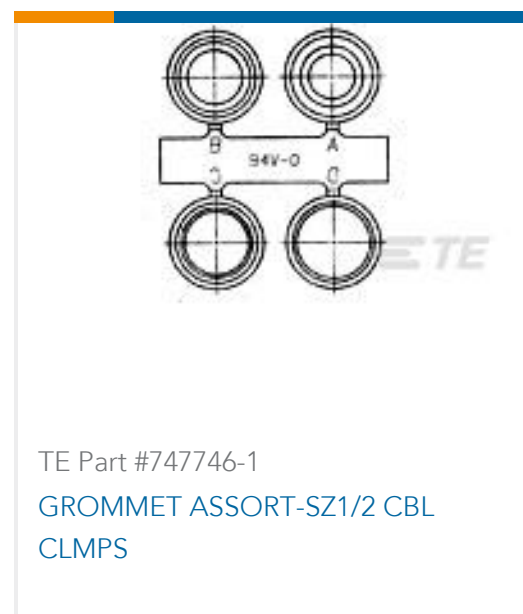

TE Part #747746-1
GROMMET ASSORT-SZ1/2 CBL
CLMPS



TE Part #1-640388-0
10P MTA156 HDR ASSY RN STR F/L



TE Part #2-327043-1
PG SPD 22-16 COMM 22-18 MIL 6



TE Part #1393143-1
27E043=SOCKET,KU,11,SLG,NYL,N

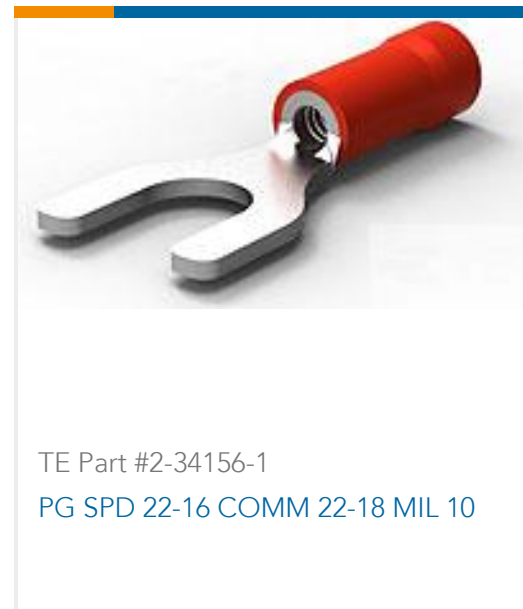

TE Part #2-34156-1
PG SPD 22-16 COMM 22-18 MIL 10



TE Part #5-146128-4
06 MODII HDR SR SFMNT B/A .100



TE Part #5-146282-4
04 MODII HDR SRST B/A .100CL



TE Part #200389-2
GUIDE PIN KIT



TE Part #2-34176-1
TERMINAL,PG SPD 12-10 10

Documents

Product Drawings

CPC RECEPT ASSEMBLY SIZE 11-9

English

CAD Files

3D PDF

3D

Customer View Model

[ENG_CVM_CVM_1-206852-1_AL.2d_dxf.zip](#)

English

Customer View Model

[ENG_CVM_CVM_1-206852-1_AL.3d_igs.zip](#)

English

Customer View Model

[ENG_CVM_CVM_1-206852-1_AL.3d_stp.zip](#)

English

By downloading the CAD file I accept and agree to the [Terms and Conditions](#) of use.

Datasheets & Catalog Pages



AMP Circular Connectors for Commercial Signal & Power Applications

English

Product Specifications

Connector, Circular Plastic

English

Product Specification

English

Product Environmental Compliance

Product Compliance

English

Product Compliance

English