

RTKA-SEMITECRTCRTDEVZ

User's Manual: Evaluation Board

Industrial and Analog Power

All information contained in these materials, including products and product specifications, represents information on the product at the time of publication and is subject to change by Renesas Electronics Corp. without notice. Please review the latest information published by Renesas Electronics Corp. through various means, including the Renesas Electronics Corp. website (<http://www.renesas.com>).

RTKA-SEMITECRTDEVZ

Evaluation Board

This reference design shows the operation of the Renesas precision products in a temperature sensor application. The application uses the Renesas Data Acquisition (DAQ) on a Stick reference design that has been modified to work with a Semitec 103AP-2 RTD temperature sensor. The system operates across the temperature range of -60°C to $+150^{\circ}\text{C}$. It has an accuracy of $\pm 1^{\circ}\text{C}$ or better.

The reference design is a self-contained demo showing a complete signal chain solution from the Semitec sensor, to the signal conditioning components consisting of a Vishay precision resistor and Renesas' precision parts, a Renesas G1C microcontroller and a Graphical User Interface (GUI). [Figure 1](#) shows the DAQ on a Stick connected to the external Semitec temperature sensor.



Figure 1. DAQ on a Stick with Semitec RTD Temperature Sensor

The complete reference design is conveniently housed in a USB stick form factor with plug-in connection for the temperature sensor. This compact design draws power through the USB port and uses a GUI to display the real time temperature readings from the temperature sensor onto the computer. [Figure 3 on page 4](#) shows the GUI interface.

[Figure 2 on page 2](#) shows a simplified block diagram of the temperature sensor design. The design uses the Semitec 103AP-2 thermistor, a Vishay Precision Group $500\Omega \pm 0.1\%$ precision resistor, the Renesas ISL28634 instrumentation amplifier, ISL21090 2.5V precision voltage reference, ISL21010 3.3V and 4.096V precision voltage references, ISL26104 24-bit delta sigma converter, and the R5F10JBC microcontroller.

Ordering Information

Part Number	Description
RTKA-SEMITECRTDEVZ	Semitec 103AP-2 RTD temperature sensor DAQ on a Stick evaluation board

Related Literature

For a full list of related documents, visit our website:

- [ISL28634](#), [ISL26104](#), [ISL21010](#), [ISL21090](#), [ISL22316](#), [ISL23328](#) device pages
- See Semitec [AP Thermistors](#) for the 103AP-2 datasheet

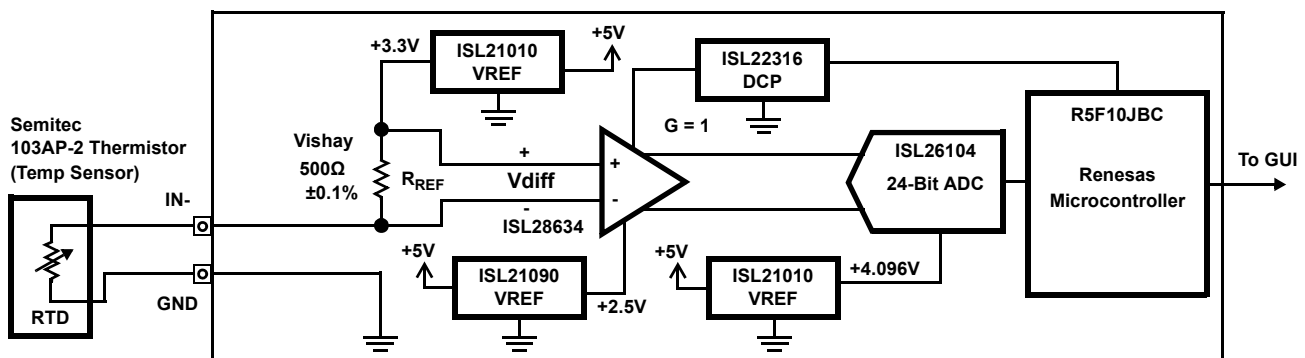

Figure 2. Simplified Reference Design Block Diagram

1. Functional Description

Power for the system is provided by the 5V VBus voltage from the USB port of the computer and is applied to the system when the DAQ on a Stick is plugged into the computer USB connector.

The resistance of the Semitec 103AP-2 thermistor changes as the temperature changes at the thermistor. It has a temperature range of -60°C to +150°C. At -60°C the typical resistance is 600.6kΩ and at +150°C the typical resistance is 308.7Ω. At +25°C it is 10kΩ. The thermistor temperature to resistance variation is not linear. Semitec provided a lookup table of the “Temperature vs Resistance” across the temperature range of -60°C to +150°C in 0.1°C increments.

A bias current is established in the temperature sensor by connecting one side of the sensor to ground and the other side in series with a 500Ω precision resistor (R_{REF}) that is connected to a 3.3V ISL21010 voltage reference (see [Figure 2 on page 2](#)). For best accuracy, a precision resistor of ±0.1% is used for R_{REF} and a precision voltage reference of ±0.2% is used for the 3.3V supply.

As the resistance of the thermistor changes with temperature, the current through the bias circuit changes, which results in a changing differential voltage as shown in [Equation 1](#).

$$(EQ. 1) \quad V_{diff} = 3.3V \left[1 - \frac{RTD}{RTD + R_{REF}} \right]$$

where:

V_{diff} = the voltage differential across the R_{REF} resistor

RTD = the thermistor resistance (varies with temperature)

R_{REF} = 500Ω ±0.1%

This equation converts the Semitec “Temperature vs Resistance” lookup table to a “Temperature vs V_{diff} ” lookup table. The lookup table converts the digitized voltage reading from the sensor to a temperature for display. Because the temperature to voltage relationship is not linear, using a lookup table approach provides the most accurate readings.

An instrumentation amplifier connected across the R_{REF} resistor reads the V_{diff} voltage and sends it to the ADC. With a 500Ω resistor for R_{REF} , the V_{diff} voltage range is from 2.74mV at -60°C to 2.04V at 150°C. The amplifier gain is set to 1V/V because the V_{diff} max voltage is at the maximum positive dynamic range of the ADC. A 2.5V voltage reference is connected to the REF pin of the instrumentation amplifier to bias the signal to the ADC for proper operation.

The ADC is setup to run in continuous mode and it sends an interrupt flag to the microcontroller every time a new data conversion sample is ready to be read. When the interrupt is received by the microcontroller, it initiates an SPI serial communication sequence that reads and stores the digitized 24-bit two’s complement data word into the memory of the microcontroller. It clears the interrupt flag to get ready to receive another sample from the ADC. In addition, it takes the stored sample and sends it to the computer GUI over the USB connection.

The GUI takes this digitized two’s complement 24-bit sample and converts it into its voltage value. It looks up the voltage value in the lookup table to find the corresponding temperature value. When the temperature value is found, it displays it on the GUI screen ([Figure 3 on page 4](#)) and plots the value on the graph. It also stores the value in a list (array), that allows you to generate a picture of the graph or export the temperature data, voltage data, and ADC output hex values to an excel file.

2. Measurement Display Screen

Click **Start** on the Startup Screen to go to the **Measurement Display Screen** (Figure 3). From this screen you can do the following:

- Start and stop data collection
- Adjust the scaling of the X and Y axes (Automatic or Manual)

Additional functionality is provided in the Menu items at the top of the Measurement Screen in the menu bar.

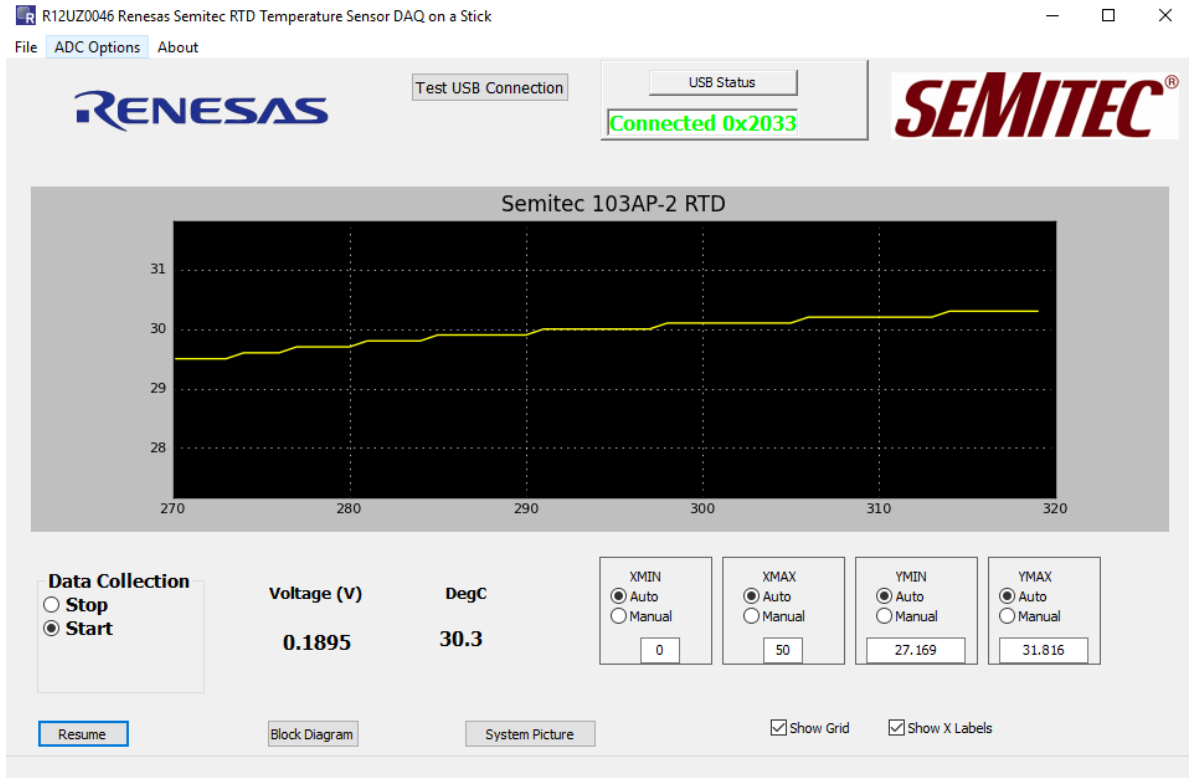

Figure 3. GUI Measurement Screen

2.1 Data Collection Radio Box

The Data Collection radio box is one of the most actively used controls.

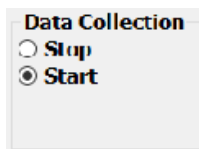

Figure 4. Data Collection Radio Box

- **Start** begins data collection and graphing in real time of the measured ADC values
- **Stop** halts data collection

2.2 Graphing X and Y Axis Control

The X and Y axis control windows enable control of the graph area horizontal (XMIN, XMAX) and vertical (YMIN, YMAX) axes.

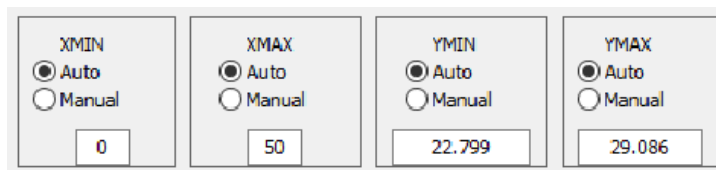

Figure 5. X and Y Axis Control

With **Auto** selected, the last 50 measurements are displayed as data collection runs, which produces a horizontal scrolling of the data.

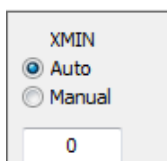

Figure 6. XMIN with Auto Selected

To see the history of the sensor reading from the beginning, pin the X axis to 0 by clicking **Manual** in the XMIN box and enter 0 in the selection window.

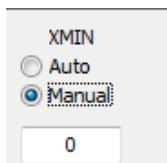

Figure 7. XMIN with Manual Selected

Typing in another value in the selection window jumps to that location.

The Y axis is automatically adjusted as data is collected. However, when graphing “flat line” waveforms, you can select **Manual** while data collection is running and zoom the Y axis in to see further detail.

During initialization, the controls are set to **Auto**. When started, you can select **Manual** and change the Y axis.

Note: The axis controls affect the graph display area only. During data export, all data collected, regardless of graph scaling, is sent to the .csv file.

2.3 Grid and X Labels Check Boxes

The **Show Grid** and **Show X Labels** boxes are graphing display options. Disable (deselect) **Show Grid** or **Show X Labels** to speed up real-time graphing display. These options can be enabled and disabled at any time.



Figure 8. Grid and X Labels Check Boxes

2.4 Block Diagram and System Picture

Click the **Block Diagram** button to see the simplified reference design block diagram shown in [Figure 2 on page 2](#), and click the **System Picture** button to see the DAQ on a Stick with Semitec RTD Temperature Sensor shown in [Figure 1 on page 2](#).

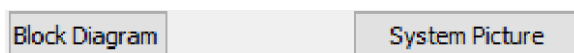

Figure 9. Block Diagram and System Picture

2.5 Measurement Display Menu Options

The Measurement Display has a Menu bar at the top.



Figure 10. Measurement Display Menu Options

- **File** exports collected data to a .csv file and captures a picture of the graph display
- **ADC Options** sets the ADC sample rate and the ADC channel and enables/disables “flushing” during real-time data collection (flushing is always disabled when using Batch mode data collection).
- **About** shows the schematic of the DAQ on a Stick and offers another way for you to read the firmware version

These items are discussed in more detail in the following sections.

2.5.1 File

In the **File** menu, click **Save Chart** to save an image of the Graph or click **Export Data** to export the collected data to a .csv file to import it into other applications.

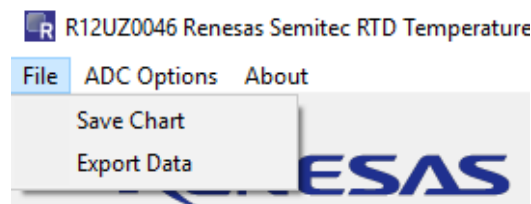

Figure 11. File Drop-Down Menu

2.5.2 About

The **About** menu provides information about the firmware version, a system picture, and a block diagram of the circuit.

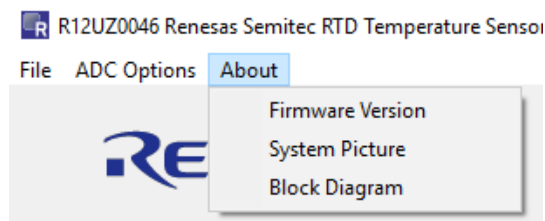

Figure 12. About Drop-Down Menu

2.5.3 ADC Options

The **ADC Options** menu has two sections that are made up of radio box selections.

- **ADC Word Rate** programs the ISL26104 ADC samples per second. See the [ISL26104](#) datasheet for more information about sampling rates
- **Run Option** enables Flush and No Flush buffer operation.

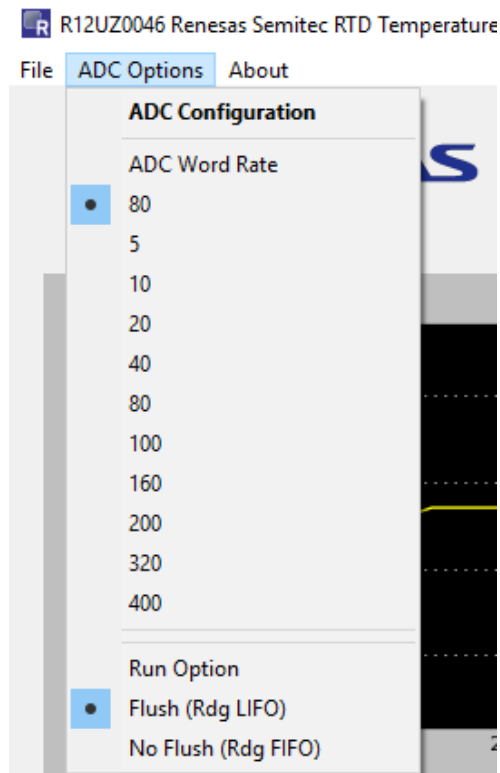

Figure 13. ADC Options Menu

3. Software Information

The GUI is written in “Python”. The firmware is written in “C” code and loaded into the microprocessor using IAR IDE work bench for Renesas RL78 1.30. The DAQ on a Stick is programmed as an HID device so no special drivers are required on the computer for USB communication.

The GUI executable, information concerning the software and information about the Renesas components used in this reference design can be obtained by contacting Renesas [Reference Designs](#).

4. Design Considerations

4.1 ISL28634 Instrumentation Amplifier

The ISL28634 is an ideal choice for the input amplifier for a temperature RTD design. The 5V Zero-Drift Rail-to-Rail Input/Output programmable gain Instrumentation Amplifier has the following features:

- Low offset
- Low noise
- Low gain error
- High CMRR

The zero drift circuitry achieves low offset and gain error drifting. The logic interface allows up to nine selectable gain settings. The differential output amplifier includes a reference pin to set the common-mode output voltage to interface with differential input ADC.

4.2 ISL26104 24-Bit ADC

The ISL26104 is a complete analog front-end with quad differential multiplexed inputs for high resolution measurements. The ISL26104 features a third order modulator providing up to 21.4-bit noise-free performance (10Sps). The 24-bit delta-sigma analog-to-digital converter includes a very low-noise amplifier with programmable gain. Although this application demo uses an input buffer amplifier (ISL28634), the high input impedance of the ISL26104 allows direct connection of sensors, to ensure the specified measurement accuracy without a buffer amplifier.

To initiate a correct power-up reset, diode D_6 , resistor R_{15} , and capacitor C_{25} implement a simple RC delay to ensure the \overline{PDWN} transitions from low-to-high after both power supplies have settled to specified levels.

4.3 ISL21090 (2.5V) Voltage Reference

The ISL21090BFB825Z is a ultra low noise, high DC accuracy precision 2.5V band-gap voltage reference with wide input voltage range. It provides a $\pm 0.02\%$ accurate reference. The ISL21090 provides up to 20mA output current sourcing. It is ideal for high-end instrumentation, data acquisition, and processing applications requiring high DC precision where low noise performance is critical.

4.4 ISL21010 (3.3V) Voltage Reference

The ISL21010CFH333 is a precision 3.3V, low dropout micropower band-gap voltage reference, which provides a $\pm 0.2\%$ accurate reference. The ISL21010 provides up to 25mA output current sourcing with low 150mV dropout voltage. The low supply current and low dropout voltage combined with high accuracy make the ISL21010 ideal for precision low powered applications.

4.5 ISL21010 (4.096V) Voltage Reference

The ISL21010CFH341 is a precision 4.096V, low dropout micropower band-gap voltage reference, which provides a $\pm 0.2\%$ accurate reference. The ISL21010 provides up to 25mA output current sourcing with low 150mV dropout voltage. The low supply current and low dropout voltage combined with high accuracy make the ISL21010 ideal for precision low powered applications.

4.6 ISL22316 DCP

The ISL22316 is a low noise, Low Power I²C bus, 128 tap DCP. The DCP can be used as a three-terminal potentiometer or as a two-terminal variable resistor in a wide variety of applications including control, parameter adjustments, and signal processing.

4.7 ISL23328 Volatile, 128 Tap, I²C Digital Potentiometer (Not Used in this Design)

The ISL23328 has a VLOGIC pin allowing operation down to 1.2V on the bus, independent from the VCC, which allows for low logic levels to be connected directly to the ISL23328 without passing through a voltage level shifter.

4.8 Bill of Materials DAQ on a Stick + RTD Temperature Sensor

Qty	Reference Designator	Description	Manufacturer	Manufacturer Part
1	C7	CAP, SMD, 0805, 4.7 μ F, 16V, 10%, X7R, ROHS	Murata	GRM21BR71C475KA73L
2	C9, C13	CAP, SMD, 0402, 10pF, 50V, 10%, NP0, ROHS	Venkel	C0402C0G500-100KNE
3	C1, C6, C25	CAP, SMD, 0402, 0.01 μ F, 16V, 10%, X7R, ROHS	TDK	C1005X7R1C103K
16	C2, C5, C14, C16, C17-C20, C22, C23, C27-C32	CAP, SMD, 0402, 0.1 μ F, 16V, 10%, X7R, ROHS	Venkel	C0402X7R160-104KNE
4	C3, C11, C12, C26	CAP, SMD, 0603, 1 μ F, 16V, 10%, X5R, ROHS	Murata	GRM188R61C105KA12D
1	C15	CAP, SMD, 0603, 0.33 μ F, 50V, 10%, X7R, ROHS	TDK	C1608X7R1H334K
1	C21	CAP, SMD, 0805, 10 μ F, 10V, 10%, X5R, ROHS	Murata	GRM21BR61A106KE19L (Pb-Free)
1	C8	CAP, SMD, 0805, 2.2 μ F, 16V, 10%, X7R, ROHS	Venkel	C0805X7R160-225KNE
1	C4	CAP, SMD, 1206, 10 μ F, 16V, 10%, X5R, ROHS	Venkel	C1206X5R160-106KNE (Pb-Free)
1	J1	CONN-USB PLUG, A TYPE, SMD, 4POS, R/A, ROHS	Molex	48037-1000
1	J2	CONN-SOCKET, TH, 12P, 2X6, INSULATED, R/A, 2.54mm, ROHS	Sullins	PPPC062LJBN-RC
1	D1	DIODE-SCHOTTKY, SMD, SOT23, 3P, 30V, 200mA, SINGLE DIODE	Fairchild	BAT54
4	D2, D4, D5, D6	DIODE-SWITCHING, SMD, 2P, SOD-123, 100V, 200mA, ROHS	On Semiconductor	MMSD4148T1G
1	D3	LED, SMD, 1206, GREEN, 75mW, 3mcd, 567nm, ROHS	Dialight	597-3311-407NF
1	L1	FERRITE BEAD-CHIP, SMD, 1206, 1k, 25%, 100MHz, 1A, ROHS	Fair-rite	2512061027Y1
1	U9	IC-3.3V LDO VOLTAGE REFERENCE, 3P, SOT23, ROHS	Renesas	ISL21010CFH333Z-TK
1	U2	IC-4.096V LDO VOLTAGE REFERENCE, 3P, SOT23, ROHS	Renesas	ISL21010CFH341Z-TK
1	U6	IC-PREC.VOLTAGE REFERENCE, 8P, SOIC, 2.5VOUT, ROHS	Renesas	ISL21090BFB825Z-TK
1	U1	IC-LO VOLT.DIGITAL POTENTIOMETER, 16P, uTQFN, ROHS	Renesas	ISL23328TFRUZ-TK
1	U10	IC-PRECISION ADC, 28P, TSSOP, ROHS	Renesas	ISL26104AVZ
1	U3	IC-DUAL RRIO OP AMP, 8P, DFN, 3x3, ROHS	Renesas	ISL28233FRZ
1	U4	IC-5V INSTRUMENTATION OP AMP, 14P, TSSOP, ROHS	Renesas	ISL28634FVZ
1	U5	IC-DUAL MULTIPLEXER ANALOG SWITCH, 20P, QFN, 4X4, ROHS	Renesas	ISL43840IRZ
1	U11	IC-SINGLE SPST ANALOG SWITCH, 6P, uTDFN, 1.2x1.0, ROHS	Renesas	ISL54054IRUZ-T
1	U7	IC-16-BIT USB MCU, PROGRAM HID2033, 32P, WFQFN, 24MHz, ROHS	Renesas Technology	R5F10JBCANA#U0
1	U8	IC-USB DUAL ESD PROTECTION, 6P, TSOP, ROHS	Nxp Semiconductor	IP4220CZ6, 125

Qty	Reference Designator	Description	Manufacturer	Manufacturer Part
1	Y1	OSC-CRYSTAL, SMD, 5X3.2, 12MHz, 120Ω, 8pF, 50ppm, ROHS	Ndk Crystals	NX5032GA-12.000000MHZ-LN-CD-1
3	R18, R23, R26	RES, SMD, 0805, 100Ω, 1/10W, 0.1%, MF, ROHS	Panasonic	ERA-3YEB101V
3	R16, R22, R25	RES, SMD, 0805, 249Ω, 1/8W, 0.1%, 25ppm, ROHS	Panasonic	ERA-6AEB2490V
1	R21	RES, SMD, 0805, 499Ω, 1/10W, 0.1%, 25ppm, MF, ROHS	Venkel	TFCR0805-10W-E-4990BT
4	R1, R6, R11, R30	RES, SMD, 0402, 0Ω, 1/16W, 5%, TF, ROHS	Venkel	CR0402-16W-00T
2	R2, R7	RES, SMD, 0402, 100Ω, 1/16W, 1%, TF, ROHS	Venkel	CR0402-16W-1000FT
1	R3	RES, SMD, 0402, 1k, 1/16W, 1%, TF, ROHS	Venkel	CR0402-16W-1001FT
4	R8, R9, R28, R29	RES, SMD, 0402, 10k, 1/16W, 1%, TF, ROHS	Panasonic	ERJ-2RKF1002X
1	R10	RES, SMD, 0402, 221Ω, 1/16W, 1%, TF, ROHS	Venkel	CR0402-16W-2210FT
7	R12, R13, R20, RC16, RC18	RES, SMD, 0402, 4.99k, 1/16W, 1%, TF, ROHS	KDA	RK73H1E4991F
2	R4, R5, R14, R15	RES, SMD, 0402, 49.9Ω, 1/16W, 1%, TF, ROHS	Panasonic	ERJ-2RKF49R9X
1	R17	RES, SMD, 0603, 3k, 1/10W, 1%, TF, ROHS	Yageo	RC0603FR-073KL
3	R19, R24, R27	RES, SMD, 0805, 1Ω, 1/8W, 1%, TF, ROHS	Venkel	CR0805-8W-1R00FT
0	P1, P2	DO NOT POPULATE OR PURCHASE		

4.9 RTKA-BDGSTKEV1Z Evaluation Board Layout

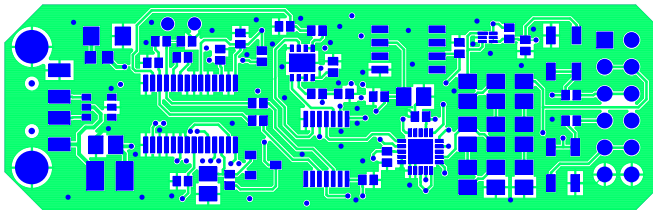

Figure 14. Top Layer

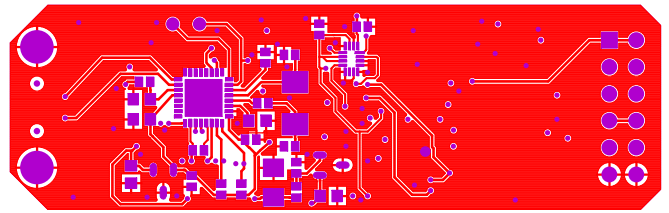

Figure 15. Bottom Layer

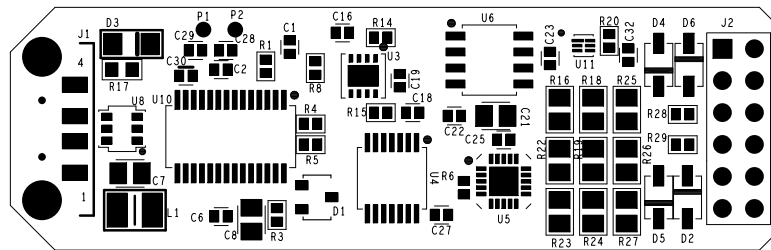

Figure 16. Top Assembly Drawing

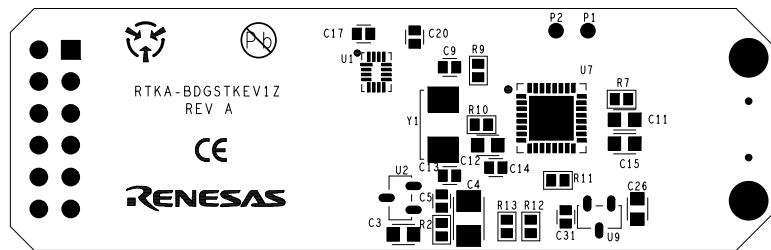

Figure 17. Bottom Assembly Drawing

4.10 Reference Design Schematics

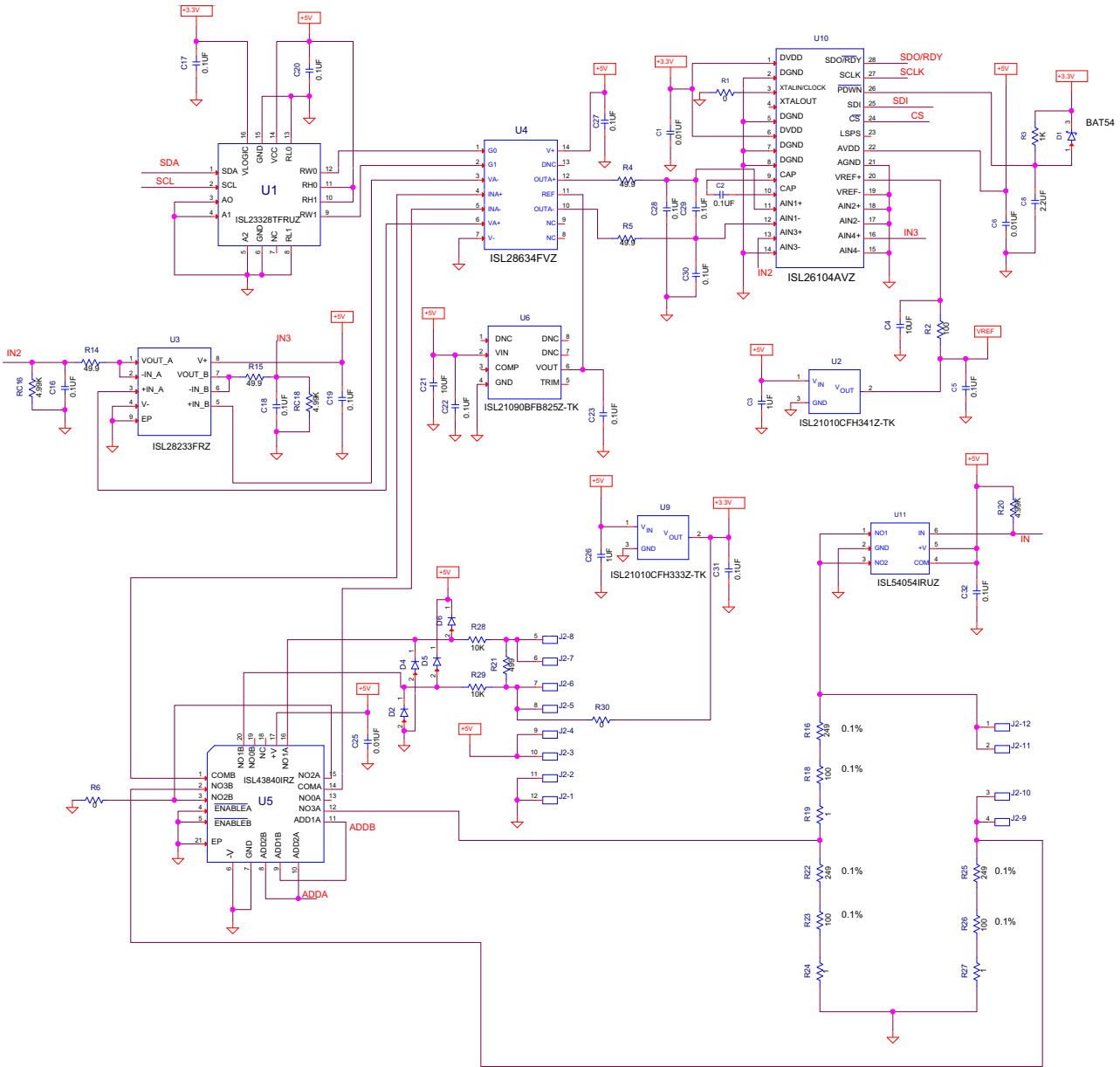

Figure 18. RTKA-SEMITECRTDEVZ Temperature Sensor Schematic

5. Revision History

Rev.	Date	Description
1.02	Jun.27.19	Updated links. Updated BOM
1.01	May.20.19	Changed RTKA-SEMITECRTDEVAZ to: RTKA-SEMITECRTDEVZ.
1.00	Apr.8.19	Initial release

Notice

1. Descriptions of circuits, software and other related information in this document are provided only to illustrate the operation of semiconductor products and application examples. You are fully responsible for the incorporation or any other use of the circuits, software, and information in the design of your product or system. Renesas Electronics disclaims any and all liability for any losses and damages incurred by you or third parties arising from the use of these circuits, software, or information.
2. Renesas Electronics hereby expressly disclaims any warranties against and liability for infringement or any other claims involving patents, copyrights, or other intellectual property rights of third parties, by or arising from the use of Renesas Electronics products or technical information described in this document, including but not limited to, the product data, drawings, charts, programs, algorithms, and application examples.
3. No license, express, implied or otherwise, is granted hereby under any patents, copyrights or other intellectual property rights of Renesas Electronics or others.
4. You shall not alter, modify, copy, or reverse engineer any Renesas Electronics product, whether in whole or in part. Renesas Electronics disclaims any and all liability for any losses or damages incurred by you or third parties arising from such alteration, modification, copying or reverse engineering.
5. Renesas Electronics products are classified according to the following two quality grades: "Standard" and "High Quality". The intended applications for each Renesas Electronics product depends on the product's quality grade, as indicated below.
 - "Standard": Computers; office equipment; communications equipment; test and measurement equipment; audio and visual equipment; home electronic appliances; machine tools; personal electronic equipment; industrial robots; etc.
 - "High Quality": Transportation equipment (automobiles, trains, ships, etc.); traffic control (traffic lights); large-scale communication equipment; key financial terminal systems; safety control equipment; etc.Unless expressly designated as a high reliability product or a product for harsh environments in a Renesas Electronics data sheet or other Renesas Electronics document, Renesas Electronics products are not intended or authorized for use in products or systems that may pose a direct threat to human life or bodily injury (artificial life support devices or systems; surgical implantations; etc.), or may cause serious property damage (space system; undersea repeaters; nuclear power control systems; aircraft control systems; key plant systems; military equipment; etc.). Renesas Electronics disclaims any and all liability for any damages or losses incurred by you or any third parties arising from the use of any Renesas Electronics product that is inconsistent with any Renesas Electronics data sheet, user's manual or other Renesas Electronics document.
6. When using Renesas Electronics products, refer to the latest product information (data sheets, user's manuals, application notes, "General Notes for Handling and Using Semiconductor Devices" in the reliability handbook, etc.), and ensure that usage conditions are within the ranges specified by Renesas Electronics with respect to maximum ratings, operating power supply voltage range, heat dissipation characteristics, installation, etc. Renesas Electronics disclaims any and all liability for any malfunctions, failure or accident arising out of the use of Renesas Electronics products outside of such specified ranges.
7. Although Renesas Electronics endeavors to improve the quality and reliability of Renesas Electronics products, semiconductor products have specific characteristics, such as the occurrence of failure at a certain rate and malfunctions under certain use conditions. Unless designated as a high reliability product or a product for harsh environments in a Renesas Electronics data sheet or other Renesas Electronics document, Renesas Electronics products are not subject to radiation resistance design. You are responsible for implementing safety measures to guard against the possibility of bodily injury, injury or damage caused by fire, and/or danger to the public in the event of a failure or malfunction of Renesas Electronics products, such as safety design for hardware and software, including but not limited to redundancy, fire control and malfunction prevention, appropriate treatment for aging degradation or any other appropriate measures. Because the evaluation of microcomputer software alone is very difficult and impractical, you are responsible for evaluating the safety of the final products or systems manufactured by you.
8. Please contact a Renesas Electronics sales office for details as to environmental matters such as the environmental compatibility of each Renesas Electronics product. You are responsible for carefully and sufficiently investigating applicable laws and regulations that regulate the inclusion or use of controlled substances, including without limitation, the EU RoHS Directive, and using Renesas Electronics products in compliance with all these applicable laws and regulations. Renesas Electronics disclaims any and all liability for damages or losses occurring as a result of your noncompliance with applicable laws and regulations.
9. Renesas Electronics products and technologies shall not be used for or incorporated into any products or systems whose manufacture, use, or sale is prohibited under any applicable domestic or foreign laws or regulations. You shall comply with any applicable export control laws and regulations promulgated and administered by the governments of any countries asserting jurisdiction over the parties or transactions.
10. It is the responsibility of the buyer or distributor of Renesas Electronics products, or any other party who distributes, disposes of, or otherwise sells or transfers the product to a third party, to notify such third party in advance of the contents and conditions set forth in this document.
11. This document shall not be reprinted, reproduced or duplicated in any form, in whole or in part, without prior written consent of Renesas Electronics.
12. Please contact a Renesas Electronics sales office if you have any questions regarding the information contained in this document or Renesas Electronics products.

(Note1) "Renesas Electronics" as used in this document means Renesas Electronics Corporation and also includes its directly or indirectly controlled subsidiaries.

(Note2) "Renesas Electronics product(s)" means any product developed or manufactured by or for Renesas Electronics.

(Rev.4.0-1 November 2017)

Corporate Headquarters

TOYOSU FORESIA, 3-2-24 Toyosu,
Koto-ku, Tokyo 135-0061, Japan
www.renesas.com

Trademarks

Renesas and the Renesas logo are trademarks of Renesas Electronics Corporation. All trademarks and registered trademarks are the property of their respective owners.

Contact Information

For further information on a product, technology, the most up-to-date version of a document, or your nearest sales office, please visit:
www.renesas.com/contact/

RTKA-SEMITECRTCRTDEVZ