



LED Display Product Data Sheet LTS-5001AWC

Spec No.: DS-30-96-166

Effective Date: 02/13/2008

Revision: A

LITE-ON DCC

RELEASE

BNS-OD-FC001/A4

LED DISPLAY**LTS-5001AWC**
DATASHEET

<u>Rev</u>	<u>Description</u>	<u>By</u>
01	ORIGINAL (Refer to contour drawing Revision (-))	<u>KOKO HSU</u> <u>04/19/2000</u>
(Above data for PD and Customer tracking only)		
-	NPPR Received and Upload on OPNC	<u>KOKO HSU</u> <u>04/19/2000</u>
A	Change spec pin length from 3.76mm to 5.00 mm	<u>KITTISAK</u> <u>01/25/2008</u>

SPEC. NO.: **DS-30-96-166**DATE : **01/25/2008**REV. NO. : **A**PAGE NO. : **0 OF 5**

FEATURES

- * 0.56 inch (14.22 mm) DIGIT HEIGHT.
- * CONTINUOUS UNIFORM SEGMENTS
- * LOW POWER REQUIREMENT.
- * EXCELLENT CHARACTERS APPEARANCE.
- * HIGH BRIGHTNESS & HIGH CONTRAST.
- * WIDE VIEWING ANGLE.
- * SOLID STATE RELIABILITY.
- * CATEGORIZED FOR LUMINOUS INTENSITY.

DESCRIPTION

The LTS-5001AWC is a 0.56 inch (14.22 mm) digit height single digit low current seven-segment display. This device utilizes AlGaAs red LED chips, which are made from AlGaAs on a non-transparent GaAs substrate, and has a gray face and white segments.

This low current seven-segment display is designed to perform under low power consumption. It is tested and selected for its excellent low current characteristics. It can be driven in low current condition and the segments are matched. This driving current as low as 1mA per segment is applicable.

DEVICE

PART NO.	DESCRIPTION
AlGaAs RED	COMMON ANODE
LTS-5001AWC	RT. HAND DECIMAL

PACKAGE DIMENSIONS

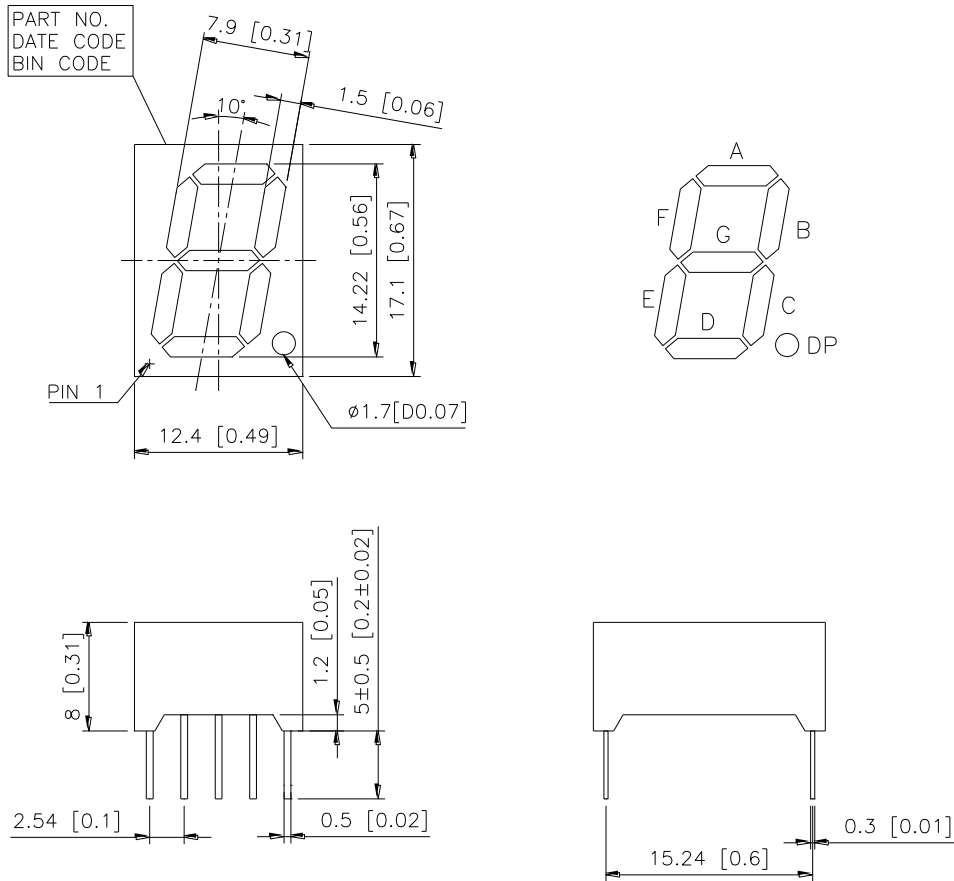

NOTES: All dimensions are in millimeters. Tolerance is ± 0.25 mm (0.01") unless otherwise noted.

INTERNAL CIRCUIT DIAGRAM

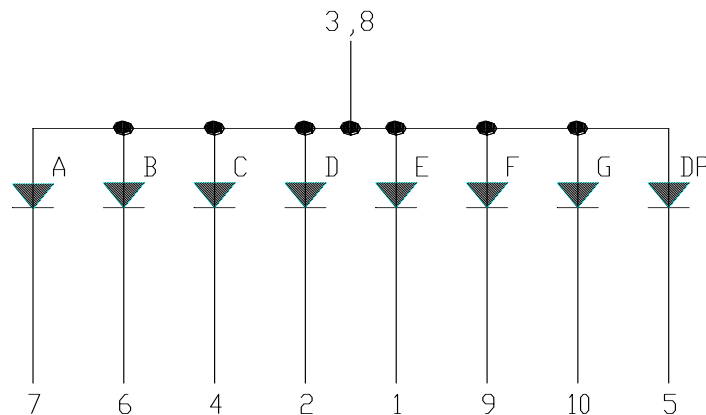

PIN CONNECTION

NO	CONNECTION
1	CATHODE E
2	CATHODE D
3	COMMON ANODE *1
4	CATHODE C
5	CATHODE D.P.
6	CATHODE B
7	CATHODE A
8	COMMON ANODE *1
9	CATHODE F
10	CATHODE G

NOTE : 1. PIN 3 & 8 ARE INTERNALLY CONNECTED.

ABSOLUTE MAXIMUM RATING AT Ta=25°C

PARAMETER	MAXIMUM RATING	UNIT
Power Dissipation Per Segment	75	mW
Peak Forward Current Per Segment (1/10 Duty Cycle, 0.1ms Pulse Width)	125	mA
Continuous Forward Current Per Segment	30	mA
Derating Linear From 25°C Per Segment	0.4	mA/°C
Reverse Voltage Per Segment	5	V
Operating Temperature Range	-35°C to +85°C	
Storage Temperature Range	-35°C to +85°C	
Solder Temperature: max 260°C for max 3sec at 1.6mm[1/16inch] below seating plane.		

ELECTRICAL / OPTICAL CHARACTERISTICS AT Ta=25°C

PARAMETER	SYMBOL	MIN.	TYP.	MAX.	UNIT	TEST CONDITION
Average Luminous Intensity	I _v	320	700		μcd	I _F =1mA
			3750		μcd	I _F =5mA
Peak Emission Wavelength	λ _p		660		nm	I _F =20mA
Spectral Line Half-Width	Δλ		35		nm	I _F =20mA
Dominant Wavelength	λ _d		638		nm	I _F =20mA
Forward Voltage Per Segment	V _F		1.6	2.4	V	I _F =1mA
			1.7			I _F =5mA
			1.8			I _F =20mA
Reverse Current Per Segment	I _R			100	μA	V _R =5V
Luminous Intensity Matching Ratio	I _v -m			2:1		I _F =10mA

Note: Luminous intensity is measured with a light sensor and filter combination that approximates the CIE (Commision International De L'Eclairage) eye-response curve.

TYPICAL ELECTRICAL / OPTICAL CHARACTERISTIC CURVES

(25°C Ambient Temperature Unless Otherwise Noted)

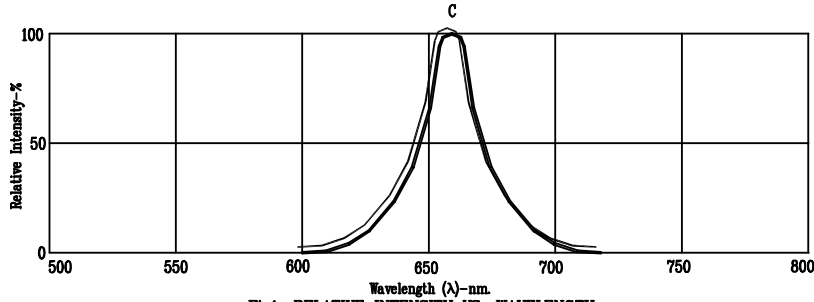

Fig1. RELATIVE INTENSITY VS. WAVELENGTH

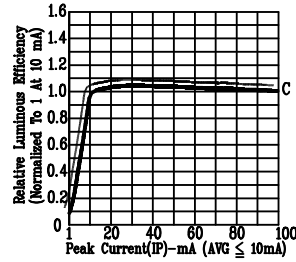

Fig2. RELATIVE LUMINOUS EFFICIENCY (LUMINOUS INTENSITY PER UNIT CURRENT) VS. PEAK CURRENT (REFRESH RATE 1KHz)

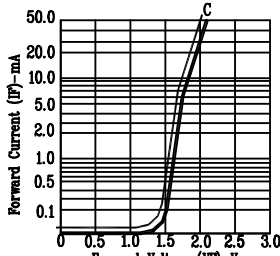

Fig3. FORWARD CURRENT VS. FORWARD VOLTAGE

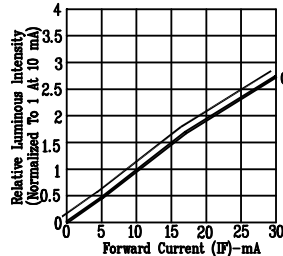

Fig4. RELATIVE LUMINOUS INTENSITY VS. FORWARD CURRENT

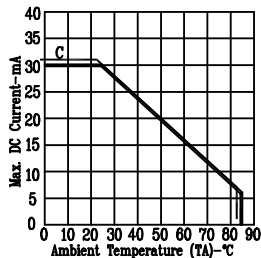

Fig5. MAX. ALLOWABLE DC CURRENT VS. AMBIENT TEMPERATURE.

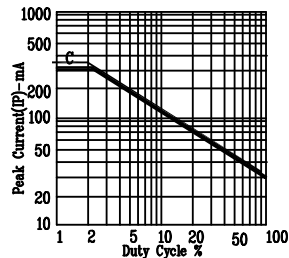

Fig6. MAX. PEAK CURRENT VS. DUTY CYCLE % (REFRESH RATE 1KHz)

NOTE: C=AlGaAs RED