

PRODUCT NUMBER SEE SHEET 2

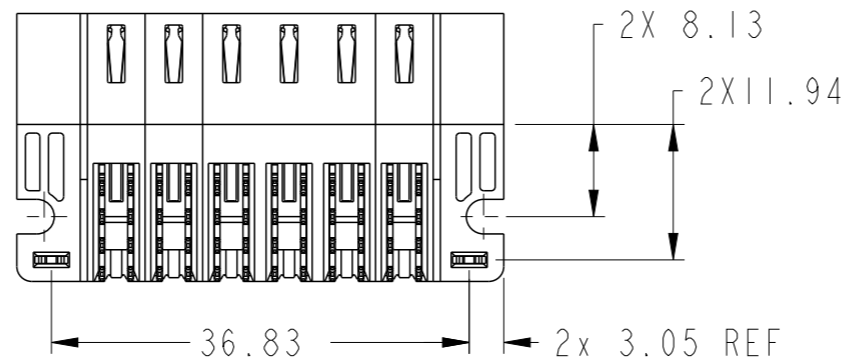
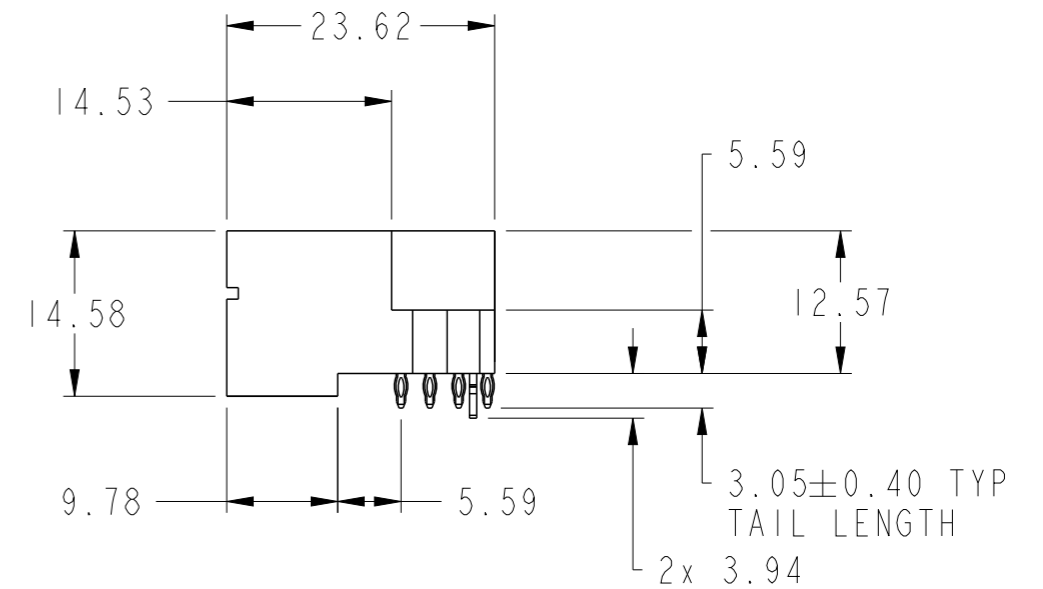
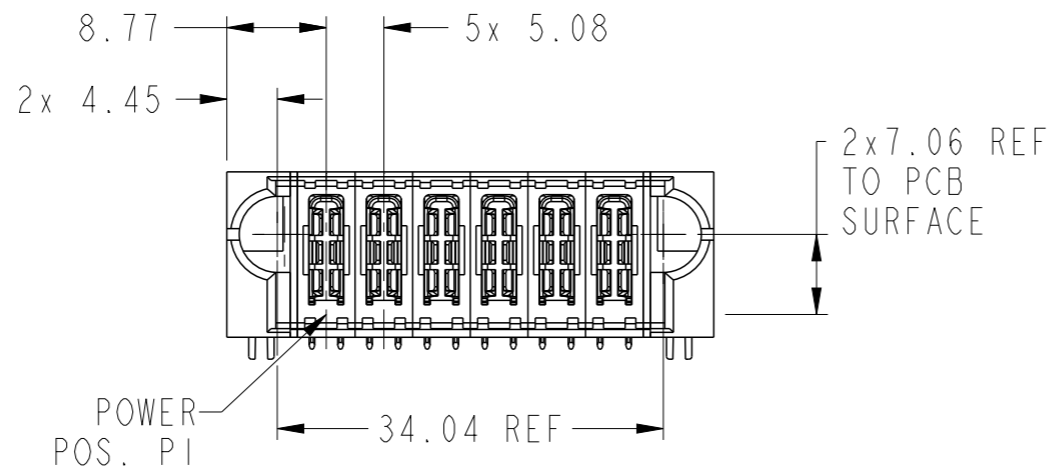
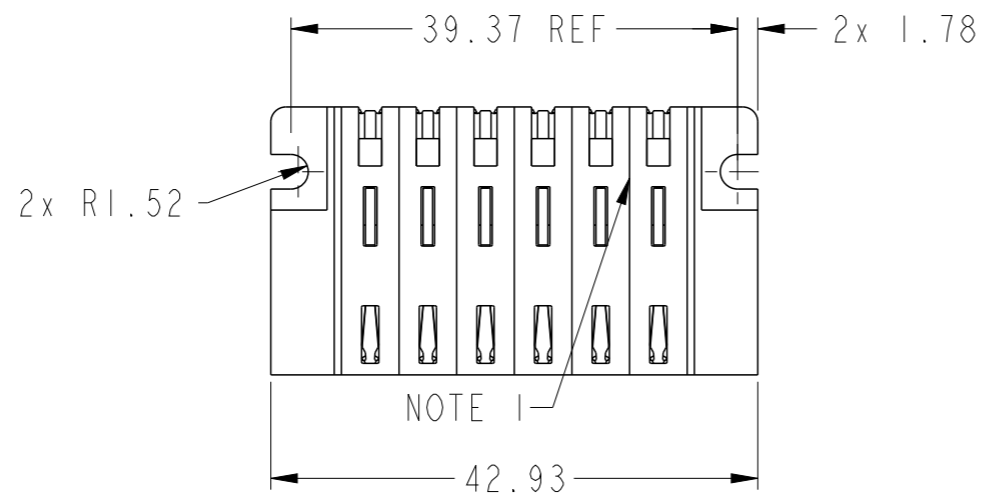

spec ref	*	dr	Jes Wu	2014/07/17	projection	MM	size	A3	scale	3:2
tolerance std	ASME Y14.5	eng	Rainbow Zhan	2014/08/15			ecn no		-	
TOLERANCES UNLESS OTHERWISE SPECIFIED		chr	Li-He	2014/08/14			rel level		Released	
surface	<input checked="" type="checkbox"/> linear <input type="checkbox"/> angular	appr	Pei-Ming Zheng	2014/08/15	product family		PwrBlade+		rel level	
ASME Y14.5	linear 0.X ±0.5 0.XX ±0.25 0.XXX ±0.10 angular 0° ±2°			title 6HDP RA PF HEADER		dwg no 10106133-6000001		rev A		
www.fci.com		cat. no.		Product - Customer Drw			sheet 1 of 3			

1

2

3

4

PRODUCT NO. 10106133-6000001LF	ROWS DCBA	HIGH POWER						E2	
		E1	P1	P2	P3	P4	P5		P6
		HA	HE	HE	HE	HE	HE	HE	HA

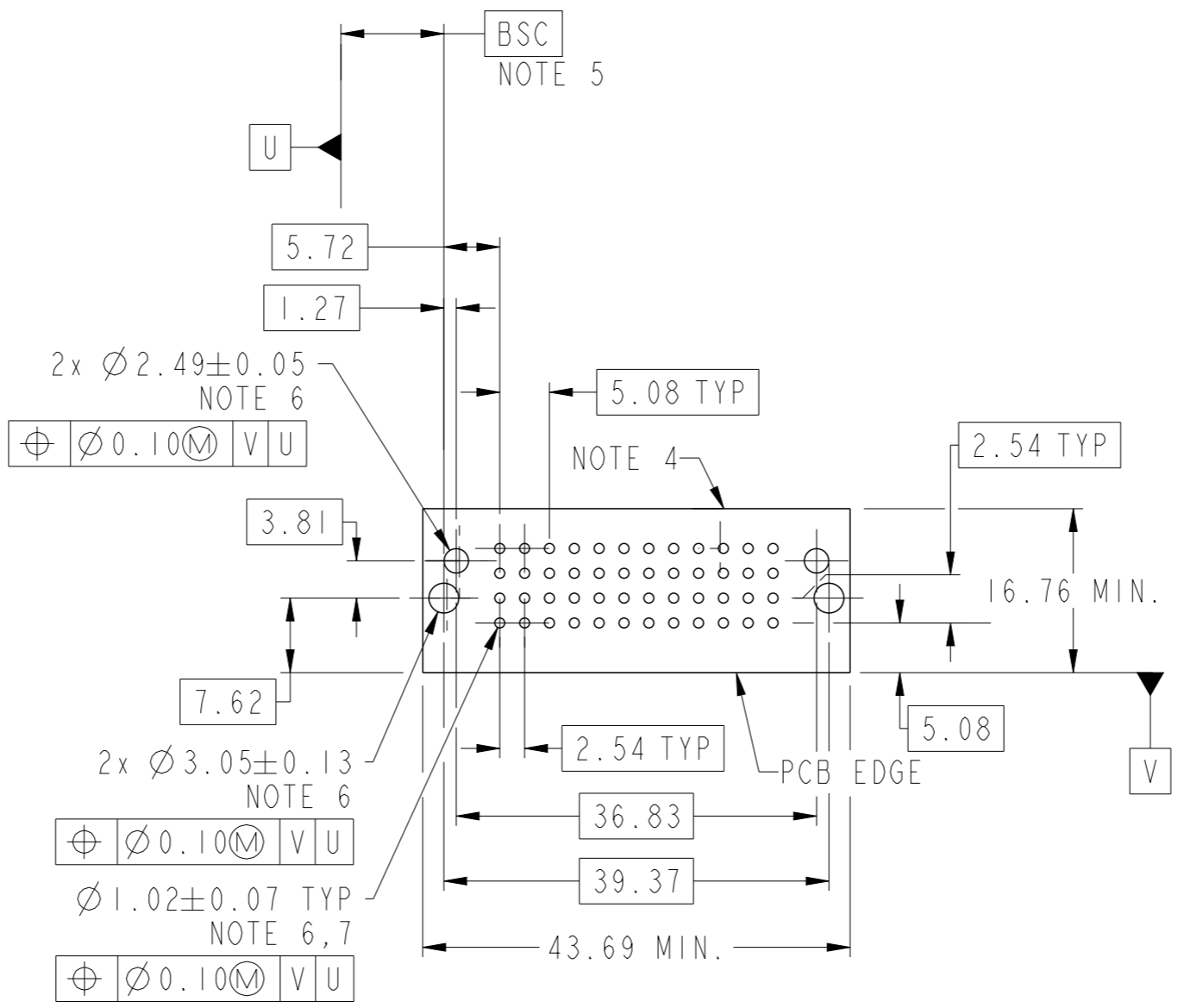

Copyright FCI.

CODE	DESCRIPTION
HA	METAL HOLD DOWN
HE	STD HIGH POWER CONTACT (3.05)

dr	Jes Wu	2014/07/17	projection 	MM	size	A3	scale	3:2
eng	Rainbow Zhan	2014/08/15			ecn no	-		
chr	Li-He	2014/08/14			rel level	Released		
appr	Pei-Ming Zheng	2014/08/15			product family	PwrBlade+		



	title	6HDP RA PF HEADER	dwg no	10106133-6000001	rev	A
	www.fci.com	cat. no.	Product - Customer Drw		sheet 2 of 3	

NOTES:

- 1) "FCI", PART NUMBER AND DATE CODE TO BE MARKED ON THIS SURFACE.
THE MARK CAN BE OMITTED IF THERE IS NOT ENOUGH SPACE ON THIS SURFACE.
- 2) MATERIALS:
-HOUSING - GLASS FILLED WITH HIGH TEMP THERMOPLASTIC, UL94V-0.
-SIGNAL CONTACT - COPPER ALLOY.
-POWER CONTACT - HIGH CONDUCTIVITY COPPER ALLOY.
- 3) PLATING SPECIFICATION REFER TO FCI 10116351
- 4) DENOTES CONNECTOR KEEP OUT ZONE.
- 5) DATUM AND BASIC DIMENSIONS WERE ESTABLISHED BY CUSTOMER.
- 6) ALL HOLE DIAMETERS ARE FINISHED HOLE SIZES.
- 7) 1.15±0.025MM DRILLED HOLE PLATED WITH 0.00762MM MIN Sn
OVER 0.0254-0.0762MM Cu PLATING TO ACHIEVE A 1.02±0.07MM HOLE.
- 8) PRODUCT SPECIFICATION REFER TO FCI GS-12-658.
APPLICATION SPECIFICATION REFER TO FCI GS-20-141.
PRODUCT PACKAGED IN TRAYS, REFER TO FCI GS-14-1502.

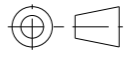
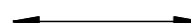

Copyright FCI.

dr	Jes Wu	2014/07/17	projection 	MM 	size	A3	scale	3:2
eng	Rainbow Zhan	2014/08/15			ecn no	-		
chr	Li-He	2014/08/14			product family	PwrBlade+	rel level	Released
appr	Pei-Ming Zheng	2014/08/15				title 6HDP RA PF HEADER	dwg no 10106133-6000001	rev A
www.fci.com			cat. no.	Product - Customer Drw		sheet 3 of 3		