



HB3AC Model Shown

FEATURES

- 1,224W continuous total output power
- 96% efficiency at 50% Load, 80 Plus® certified Titanium
- IEC 60320 C14¹ Input connector
- 12V main output
- 12V and 3.3/5V selectable standby models
- Low-profile 1U package
- 54.5mm x 228.6mm (2.15" x 9.0")
- >40 Watts per cubic inch density
- N+1 redundant, hot swap capable
- Active current sharing on 12V main output; Integral ORing/isolation is provided for both outputs
- Integral variable speed cooling fan
- Output voltage, current and temperature Protected
- PMBus™ 1.2 with LED status indicators
- Rapid-On Cold Redundant Capability
- RoHS compliant
- Two-year warranty

¹Back-Front airflow models (-Hx4TAC) use C16 input voltage sockets

PRODUCT OVERVIEW

D1U54T-W-1200-12-HxxxAC is a series of 1224W, 80 PLUS® Certified Titanium front-end power supplies that provide a 12Vdc Main and a Standby Output. Features include active current sharing, status indicator LEDs, hardware logic signals, comprehensive PMBus™ 1.2 compliant serial digital communications capability and robust fault protection. The low profile, >40W/cubic inch packaging make this series ideal for delivering reliable power to servers, workstations, storage systems and other applications requiring 12V distributed power architectures.

ORDERING GUIDE

Part Number	Output Power, Vin Nominal ¹		Main Output	Standby Output	Airflow Direction	Input connector
	100Vac	110-240Vac / 240Vdc				
D1U54T-W-1200-12-HB3AC	1100W	1,224W ³	12Vdc	12Vdc	F→B	C14
D1U54T-W-1200-12-HB4TAC					B→F	C16
D1U54T-W-1200-12-HU3AC				3.3/5Vdc ²	F→B	C14
D1U54T-W-1200-12-HU4TAC					B→F	C16

¹ 50°C Ambient temperature, refer to [derating](#) curves for additional details

² user [selectable](#)

³ Includes standby power

INPUT CHARACTERISTICS

Parameter	Conditions	Min.	Nom.	Max.	Units
AC Input Voltage Operating Range		90	100-240	264	Vac
DC Input Voltage Operating Range ¹		192	240	280	Vdc
AC Input Source Frequency		47	50/60	63	Hz
AC Turn-on Input Voltage	Ramp up	74		84	Vac
AC Turn-off Input Voltage	Ramp down	70		80	Vac
DC Turn-on Input Voltage	Ramp up	175		185	Vdc
DC Turn-off Input Voltage	Ramp down	160		170	Vdc
Maximum current at Vin = 100Vac	1224W			12	Arms
Inrush Current	Cold-start, 90-264Vac			30	Apk
80PLUS® Titanium Requirements²					
Efficiency, 80 Plus® Titanium Certification (Pending)	Loading, % full-load	Efficiency, Min.		PF, Min. (W/VA)	
	10%	90%		-	
	20%	94%		0.95	
	50%	96%			
	100%	91%			

¹ Only for China

² 230Vac; 25°C ambient; excludes fan power

OUTPUT VOLTAGE CHARACTERISTICS

Voltage	Parameter	Conditions	Min.	Nom.	Max.	Units
12V Main	Output Set Point	50% load; Tamb = 25°C		12.00		Vdc
	Output Set Point Accuracy		-0.5		+5	%
	Line and Load Regulation	Setpoint; temperature; line and load	-1.0		+1.0	%
	Ripple Voltage & Noise ^{1,2}	20MHz Bandwidth			120	mV p-p
	Output Current Range	110-240Vac nominal and 240Vdc	0		100	A
		100Vac Nominal	0		91.67	A
	Load Capacitance		1,000		30,000	µF
12VSB	Output Set Point	50% load; Tamb = 25°C		12.00		Vdc
	Line and Load Regulation	Setpoint; temperature; line and load	11.7		12.3	Vdc
	Ripple Voltage & Noise ^{1,2,3}	20MHz Bandwidth			120	mV p-p
	Output Current		0		2	A
3.3VSB	Load Capacitance				1,000	µF
	Output Set Point	50% load; Tamb = 25°C		3.3		Vdc
	Line and Load Regulation	Setpoint; temperature; line and load	3.14		3.46	Vdc
	Ripple Voltage & Noise ^{1,2}	20MHz Bandwidth			120	mV p-p
	Output Current		0		3	A
5VSB	Load Capacitance				3,000	µF
	Output Set Point	50% load; Tamb = 25°C		5.0		Vdc
	Line and Load Regulation	Setpoint; temperature; line and load	4.76		5.24	Vdc
	Ripple Voltage & Noise ^{1,2}	20MHz Bandwidth			120	mV p-p
	Output Current		0		3	A
	Load Capacitance				3,000	µF

¹ Ripple and noise are measured with 0.1µF of ceramic capacitance and 10 µF of tantalum capacitance on each of the power supply outputs. A short coaxial cable to the measurement scope input, is used.

² 2A minimum 12V main load is required to comply with these limits.

³ 470µF minimum capacitance required to comply with these limits.

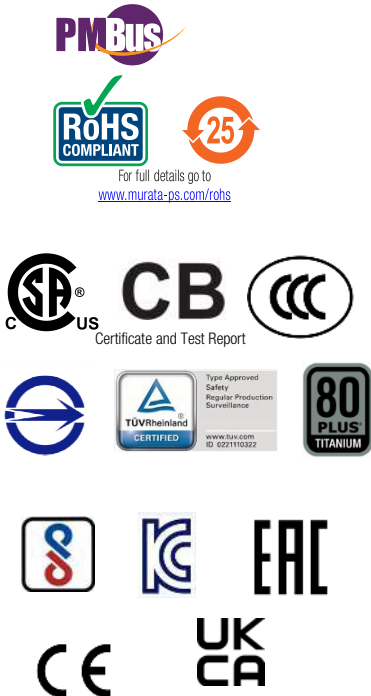

OUTPUT CHARACTERISTICS

Parameter	Conditions	Min.	Typ.	Max.	Units
Start-up time	AC ramp up			3	s
Transient Response, Main 12V and Vsb	50% load step, 1A/μs di/dt from, >10% maximum load			±5	%
				500	μs
Current sharing accuracy (Main 12V output)	>10% load; (* percentage of full load)			±5*	%
Hot Swap Transients				±5	%
Holdup Time	Full input source range; 100% load	10			ms
	Full input source range; 50% load	20			

ENVIRONMENTAL CHARACTERISTICS

Parameter	Conditions	Min.	Typ.	Max.	Units
Storage Temperature Range		-40		70	°C
¹ Operating Temperature Range	At sea-level; de-rate at 1°C /305m of altitude	-5		55	°C
Operating Humidity	Non-condensing	5		92	%
Storage Humidity		5		95	
Altitude (no derating up to 40°C) ^{1,2}				3000	m
Shock	30G non-operating				
Operational Vibration	Sine sweep; 5-200Hz, 2G; random vibration, 5-500Hz, 1.11G				
MTBF(Target)	Per Telcordia SR-332 M1C1 @40°C		400K		hrs
Safety Approvals	CAN/CSA-C22.2 No. 60950-1-07, Amendment 1:2011, Amendment 2:2014 (MOD) [CSA] ANSI/UL Std. No. 60950-1-2014 - Information Technology Equipment – Safety – Part 1: General Requirements [CSA] IEC 60950-1:2005, IEC 60950-1:2005/AMD1:2009, IEC 60950-1:2005/AMD2:2013 [CSA] EN 60950-1:2006+A11:2009+A1:2010+A12:2011+A2:2013 [TÜV Rheinland] CAN/CSA-C22.2 No. 62368-1:14 UL 62368-1 2nd Ed. IEC 62368-1:2014 EN 62368-1:2014 GB17625.1-2012, GB4943.1-2011, GB/T9254-2008 IS 13252(Part 1):2010/ IEC 60950-1 : 2005 K60950-1(2011-12) CNS13438 (095/06/01), CNS14336-1 (099/09/30), CNS 15663 [BSMI] EAC IRAM				
Input Fuse	Power Supply contains a single 250V 16A fast acting fuse				
Weight	0.912KG				

¹ Based on stand-alone free air testing; performance may vary due to back-pressure imposed by end user system; refer to the [derating curves](#) for additional details.

² Meets China safety compliance requirements to 5,000M

AIRFLOW CHARACTERISTICS – P-Q CURVES

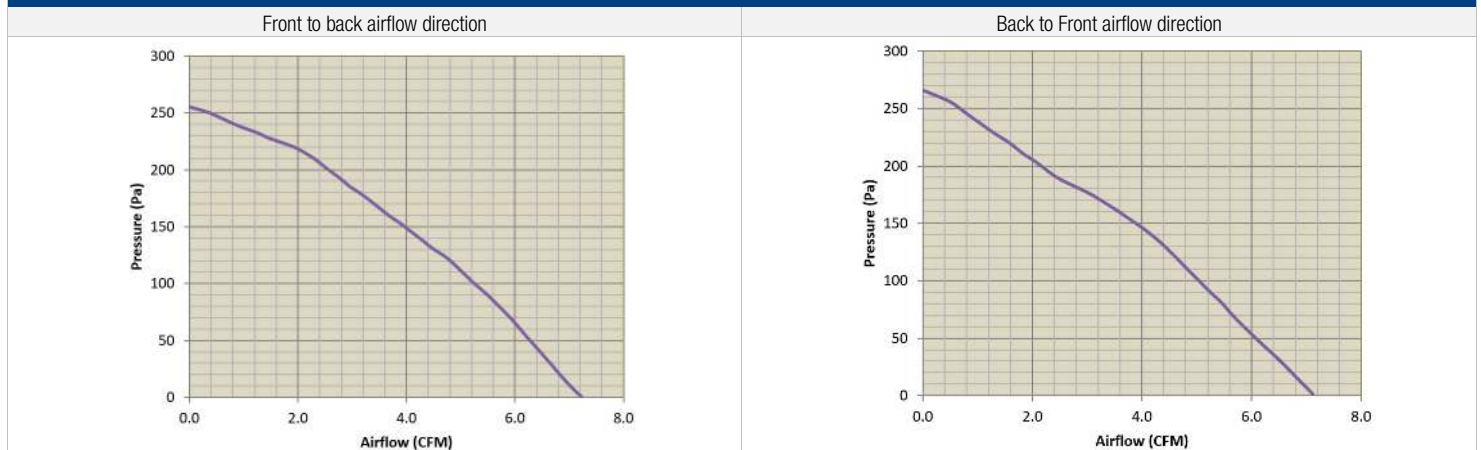

TEMPERATURE POWER DERATING CURVES^{1,2}

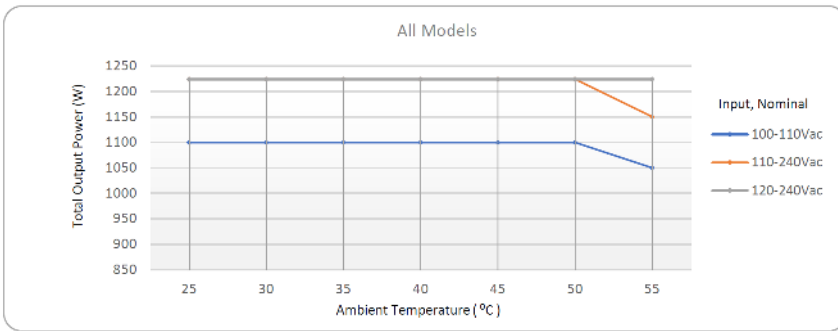

¹ Derating curve are based tests conducted at sea level as a stand-alone component, in a free-air environment. Performance characteristics when installed in an actual system/host may be impacted by backpressure imposed by the system design.
² The power supply module is designed to shut down safely upon detection of in overtemperature condition by internal hotspot temperature sensors. Refer to PMBus™ ACAN for fault limits, response and other temperature reading commands.

PROTECTION CHARACTERISTICS

Output	Parameter	Conditions	Min.	Max.	Units
	Overtemperature (intake) ^{1,2,3}	Auto restart with 4°C hysteresis for recovery (warning issued at 70°C)	70	80	°C
12V Main	Overvoltage	Latching	13.0	16.0	V
	Overcurrent	The output latches off after 5 automatic retries (1Sec interval between retries). Latch is cleared by toggling PS_ON signal or by recycling the incoming voltage source	110	120	A
			98	102	A
12VSB	Overvoltage	Latching	13.0	14.5	V
	Overcurrent	Hiccup, approximate 2 seconds between retries while fault condition persists.	2.1	2.6	A
3.3VSB	Overvoltage	Latching	3.6	4.0	V
	Overcurrent	Hiccup	3.3	4.0	A
5VSB	Overvoltage	Latching	5.4	6.0	A
	Overcurrent	Hiccup	3.3	4.0	A

¹ Warning indication (PMBus status register bits and Amber LED status) occurs at approx.. 70°C nominal and recovers at approx. 65°C nominal; fault indication and shutdown engages at approx.. 75°C nominal and recovers at 70°C nominal.

² Operating the power supply above the maximum operating temperature (see "ENVIRONMENTAL CHARACTERISTICS") is considered an abnormal condition, may negatively impact power supply life and is not recommended.

³ As reported by the intake temperature sensor. Refer to PMBus ACAN-113 for additional details

ISOLATION CHARACTERISTICS

Parameter	Conditions	Min.	Typ.	Max.	Units
Insulation Safety Rating / Test Voltage	Input to Output - Reinforced	4242			Vdc
	Input to Chassis - Basic	2121			Vdc
Output to Chassis Isolation (non-safety)		500			Vdc

EMISSIONS AND IMMUNITY

Characteristic	Standard	Compliance
Input Current Harmonics	IEC/EN 61000-3-2	Complies
Voltage Fluctuation and Flicker	IEC/EN 61000-3-3	Complies
Conducted Emissions	FCC 47 CFR Part 15 CISPR 22/EN55022	Class A with 6dB margin
ESD Immunity	IEC/EN 61000-4-2	Level 4 criteria A
Radiated Field Immunity	IEC/EN 61000-4-3	Level 3 criteria A
Electrical Fast Transients/Burst Immunity	IEC/EN 61000-4-4	Level 3 criteria A
Surge Immunity	IEC/EN 61000-4-5	1) EN61000-4-5, Lev. 3 (Com. Mode: 2kV, 12Ω, Diff. Mode: 1kV, 2Ω), criteria A 2) GR-1089-CORE (NEBS) Level 1 Table 4-30 (Com/Diff. Mode: 2kV, 2Ω)
RF Conducted Immunity	IEC/EN 61000-4-6	Level 3 criteria A
Voltage Dips, Interruptions	IEC/EN 61000-4-11	230Vin, 80% load, Phase 0°, Dip 100% Duration 10ms (A) 230Vin, 50% load, Phase 0°, Dip 100% Duration 20ms (VSB:A, V1:B) 230Vin, 100% load, Phase 0°, Dip 100% Duration > 20ms (VSB, V1:B)

LED STATUS INDICATORS¹ (Qty 2)

LED Name	LED Mode	LED state/operation	Description
Input LED (Green)	OK	Solid Green	Input voltage operating within normal specified range
	OV/UV WARNING	Blinking Green	Input voltage operating in: 1) overvoltage warning range, or 2) undervoltage warning range
	OFF OR FAULT CONDITION	Off	Input voltage operating: 1) above overvoltage range, or 2) below undervoltage range, or 3) not present
Output LED (Green/amber)	POWER GOOD	Solid Green	Both outputs operating normally; no warnings or faults
	STANDBY	Blinking Green	Main output disabled via PS_ON signal; standby output operating normally (no warnings or faults)
	WARNING	Blinking Amber	Power supply warning detected as per PMBus™ STATUS_X reporting bytes
	FAULT	Solid Amber	Power supply fault detected as per PMBus™ STATUS_X reporting bytes

¹ LED status reflects the PMBus™ status bit flags however while the bit flags are "sticky", the LED state returns to normal as soon as fault or warning condition clears.

STATUS AND CONTROL SIGNALS

Signal	I/O	Description	Interface details
INPUT_OK	In	The signal output is driven high when input source is available and within acceptable limits. The output is driven low to indicate loss of input power. There is a minimum of 2ms pre-warning time before the signal is driven low prior to the PWR_OK signal going low.	Pulled up internally via 10K to 3.3Vdc. A logic high >2.0Vdc A logic low <0.8Vdc Driven low by internal CMOS buffer (open drain output).
SB_SELECT	In	Selects the standby voltage for the HUXTC & HuxC models as follows: Left Open (no pull down)= 3.3Vdc is selected Pulled down to VSB Return = 5.0Vdc Once set and Power Supply Module operating, changing the setting will requires recycling of the input voltage to be activated.	Pulled up internally via 10K to VCC
PW_OK	Out	Asserted (or driven high), by the power supply to indicate that both the main and standby outputs are valid. If any of the outputs fail then this output will be hi-Z or driven low. The output is driven low to indicate that an output is outside of lower limit of regulation.	Pulled up internally to 10K to VDD ¹ A logic high >2.0Vdc A logic low <0.8Vdc Driven low by internal CMOS buffer (open drain output).
PS_KILL	In	This signal is used during hot swap to disable the main output during hot swap extraction. The input is pulled up internally to the internal housekeeping supply (within the power supply). The signal is provided on a short (lagging pin) and should be connected to +VSB_Return within host/system	Pulled up internally via 10K to 3.3Vdc. A logic high >2.0Vdc A logic low <0.8Vdc Input is via CMOS Schmitt trigger buffer.
SMBALERT#	Out	SMBALERT# is driven low to alert the system that the power supply has detected a fault condition(s) as defined in the PMBus ACAN, supported STATUS_XX Register fault bits. This alert asserts when any of the supported STATUS_XX register fault bits are set. This signal is driven high to indicate normal operation. SMBALERT# is reset (fault indication cleared) by either of the following, provided the fault condition is removed: 1) recycling input power 2) Issuing "CLEAR_FAULTS" PMBus command 3) toggling the PS_ON signal The LED fault indication reflects the SMBALERT# status This product supports SMBALERT_MASK command which can be used to prevent a fault or warning condition from asserting the SMBALERT# signal. Refer to PMBus ACAN for additional details.	Pulled up internally via 10K to VDD ¹ . A logic high >2.0Vdc A logic low <0.8Vdc Driven low by internal CMOS buffer (open drain output).
PRESENT_L (Power Supply Absent)	Out	The signal is used to detect the presence (installed) of a Power Supply Module by the host system. The signal is connected to Power Supply Module logic SGND within the Power Supply Module.	Passive connection to +VSB_Return. A logic low <0.8Vdc
PS_ON (Power Supply Module main output on/off control)	In	This signal is pulled up internally to the internal housekeeping supply (within the power supply). The power supply main 12Vdc output will be enabled when this signal is pulled low to +12V main or VSB_Return. In the low state the signal input shall not source more than 1mA of current. The 12Vdc output will be disabled (<0.1VDC) when the input is driven higher than 2.4V, or open circuited. Cycling this signal shall clear latched fault conditions.	Pulled up internally via 10K to VDD ¹ . A logic high >2.0Vdc A logic low <0.8Vdc Input is via CMOS Schmitt trigger buffer.
ADDR (Address Select)	In	An analog input that is used to set the address of the internal slave devices (EEPROM and microprocessor) used for PMBus™ digital communications. Connection of a suitable resistor to +VSB_Return, in conjunction with an internal resistor divider chain, will configure the required address. Refer to Address Selection Table below	DC voltage between the limits of 0 and +VDD
SCL (Serial Clock)	Both	Serial clock line compatible with PMBus Power Systems Management Protocol Part 1 – General Requirements Rev 1.1. No additional internal capacitance is added that would affect the speed of the bus. The signal is provided with a series isolator device to disconnect the internal power supply bus in the event that the Power Supply Module is unpowered.	VIL is 0.8V maximum VOL is 0.4V maximum when sinking 3mA VIH is 2.1V minimum

(Continued)
STATUS AND CONTROL SIGNALS

Signal	I/O	Description	Interface details
SDA (Serial Data)	Both	Serial data line compatible with PMBus Power Systems Management Protocol Part 1 – General Requirements Rev 1.2. The signal is provided with a series isolator device to disconnect the internal power supply bus in the event that the Power Supply Module is unpowered.	VIL is 0.8V maximum VOL is 0.4V maximum when sinking 3mA VIH is 2.1V minimum
V1_SENSE & V1SENSE_RTN	In	Remote sense connections intended to be connected at and sense the voltage at the point of load. The voltage sense will interact with the internal module regulation loop to compensate for voltage drops due to connection resistance between the output connector and the load. If remote sense compensation is not required then the voltage can be configured for local sense by: 1. V1_SENSE directly connected to power blades 6 to 10 (inclusive) 2. V1_SENSE_RTN directly connected to power blades 1 to 5 (inclusive)	Compensation for up to 0.12Vdc total connection drop (output and return connections).
ISHARE	Both	The current sharing signal is connected between sharing units (forming an ISHARE bus). It is an input and/or an output (bi-directional analog bus) as the voltage on the line controls the current share between sharing units. A power supply will respond to a change in this voltage but a power supply can also change the voltage depending on the load drawn from it. On a single unit the voltage on the pin (and the common ISHARE bus would read 8VDC at 100% load (module capability). For two identical units sharing the same 100% load this would read 4VDC for perfect current sharing (i.e. 50% module load capability per unit).	Analogue voltage: +8V maximum; 10K to +12V_RTN
RAPID_ON Additional details:	Both	RAPID_ON is compliant with Intel CRPS (cold redundant feature) and is a two state analog signal that forms the cold redundant bus. In order to operate in Cold redundant mode, the RAPID_ON signals of up to four (4) installed redundant power supply modules need to be tied together within the host/system, forming a common bus. Apart from being tied to a common point at the system end, there should be no system loading or interaction with this bus which is utilized by the Power Supply Modules for cold redundant mode operation. Activation of colder redundant operation requires configuration via PMBus™. Refer to the application notes for further details. Rapid_ON functions: <ul style="list-style-type: none"> ■ Pull-up bus voltage: Bus pull-up is provided by the single Power Supply Module or the first Power Supply Module assigned the roll of “ACTIVE & MASTER” aka “COLD_REDUNDANT ACTIVE”. More than one Power Supply Module can be assigned as “ACTIVE” only the first Power Supply Module assigned this roll provides the pull-up path and is why this Power Supply Module is referred to as the “Master”. ■ Each bus connected Power Supply Module drives the Rapid_ON bus low when any fault is detected. ■ Each bus connected Power Supply Module powers on its main output rapidly within 100µS after detection of LOW state. 	RAPID_ON: Tri-State, driven high (3.3VDC) = Cold_Red, Open or High Z = Standard_Red Driven low = Active_Cold_Red

ADDRESS SELECTION TABLE PMBus SLAVE DEVICES

ADDR pin (A3) resistor to GND (K-ohm, 1%)	Power Supply Main Controller (Serial Communications Slave Address)	Power Supply External EEPROM (Serial Communications Slave Address)
0.82	0xB0	0xA0
2.7	0xB2	0xA2
5.6	0xB4	0xA4
8.2	0xB6	0xA6
15	0xB8	0xA8
27	0xBA	0xAA
56	0xBC	0xAC
180	0xBE	0xAE

Back to [ADDR signal description](#)

TIMING SPECIFICATIONS

Turn-On Delay & Output Rise Time

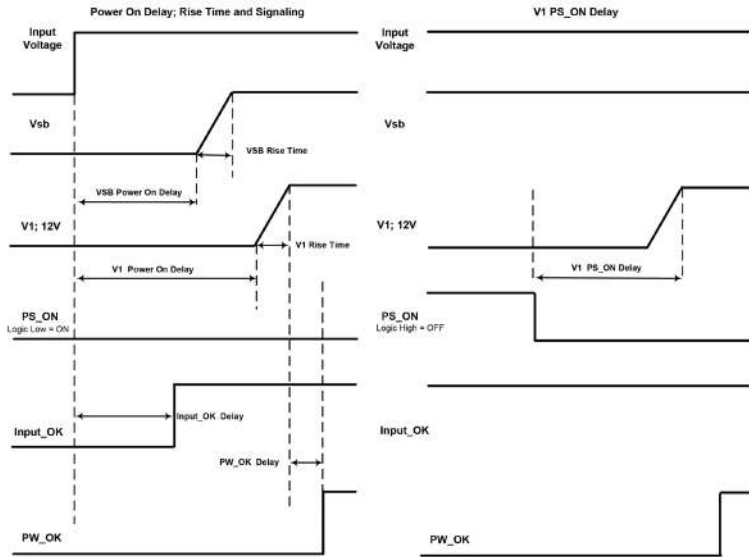

Time	Min	Max
Vsb Rise time ¹	50ms	200ms
V1 Rise time ¹	1ms	120ms
Vsb Power-on-delay		2700ms
V1 Power-on-delay		3000ms
V1 PS_ON delay	50ms	150ms
V1 PWOK delay	100ms	300ms
INPUT_OK detect	100ms	600ms

¹ from 10% to 90% Nominal output VDC

1. The turn-on delay after application of AC input within the operating range shall as defined in the following tables.
2. The output rise times shall be measured from 10% of the nominal output to the lower limit of the regulation band as defined in the following tables.

TIMING SPECIFICATIONS CONTINUED

Turn-Off (Shutdown by PS_ON)

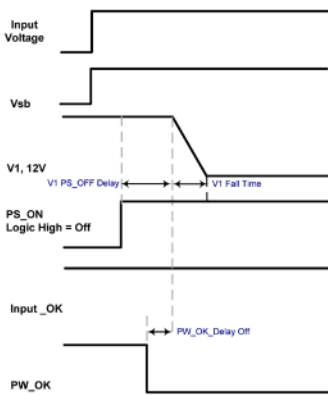

Time	Min	Max	Notes
V1 Fall time	-	-	Must be monotonic
V1 PS_OFF delay	0ms	5ms	
PW_OK delay off	0.5ms		

This characteristic is applicable for the main 12Vdc output shutdown from PS_ON pulled high.

TIMING SPECIFICATIONS CONTINUED

Power Removal Holdup

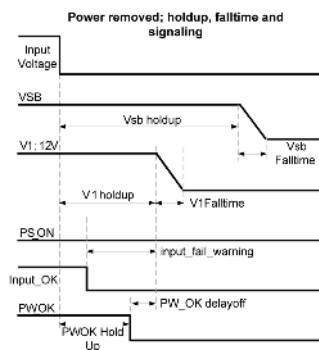

Power Removal Timing	Min	Max	Notes
Vsb holdup	40ms	-	
V1 holdup	10ms	-	100% load
INPUT fail detect	3.0ms	8.0ms	
PWOK delay off	0.5ms		

OUTPUT CONNECTOR SPECIFICATION

PART NUMBER	ROWS	SIGNALS					POWERS									
		1	2	3	4	5	1	2	3	4	5	6	7	8	9	10
1926734-2	TH Q W X	2	2	2	2	1	2	2	2	2	2	2	2	2	2	2

255 X 10P

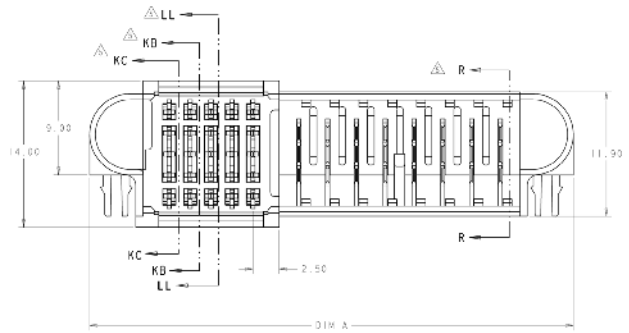

Note: "2" refers to the longest signal pin/power blade & "1" is the "shortest" signal pin such that the "shortest" is the "last to make, first to break" in the mating sequence.

Mfg. and Part Numbers:

TE Connectivity 1926734-2 (Power Supply)
FCI 10108888-R10253SLF (Mating connector)
TE Connectivity PN 2-1926739-5 (Mating Connector)

OUTPUT CONNECTOR PIN ASSIGNMENTS

Pin	Signal Name	Comments	Pin	Signal Name	Comments
6,7,8,9,10	V1 (+12VOUT)	+12V Main Output	C3	SDA	I2C Serial Data Line
1, 2, 3, 4, 5	+12V RTN/PGND	+12V Main Output Return	D3	V1_SENSE_R	-VE Remote Sense Return
A1	+VSB	Standby Output	E3	V1_SENSE	+VE Remote Sense
B1	+VSB	Standby Output	A4	SCL	I2C Serial Clock Line
C1	+VSB	Standby Output	B4	PS_ON_L	Remote On/Off (Enable/Disable)
D1	+VSB	Standby Output	C4	SMBALERT#	Alert signal to host system
E1	+VSB	Standby Output	D4	Unused	No End User Connection
A2	+VSB_Return	Standby Output Return	E4	INPUT_OK	Input Source voltage Present & "OK"
B2	+VSB_Return	Standby Output Return	A5	PS_KILL	Power Supply "kill"; short pin
C2	Rapid_ON	No End User Connection	B5	ISHARE	Active Current Share Bus
D2	Unused	No End User Connection	C5	PW_OK	Power "OK"; short pin
E2	Unused	No End User Connection	D5	SB_SELECT	Standby voltage select pin
A3	ADDR	I2C Address Protocol Selection; (Select address by appropriate pull down resistor See table for details)	E5	PRESENT_L	Power Module Present; short pin
B3	Unused	No End User Connection			

1+1 WIRING DIAGRAM EXAMPLE

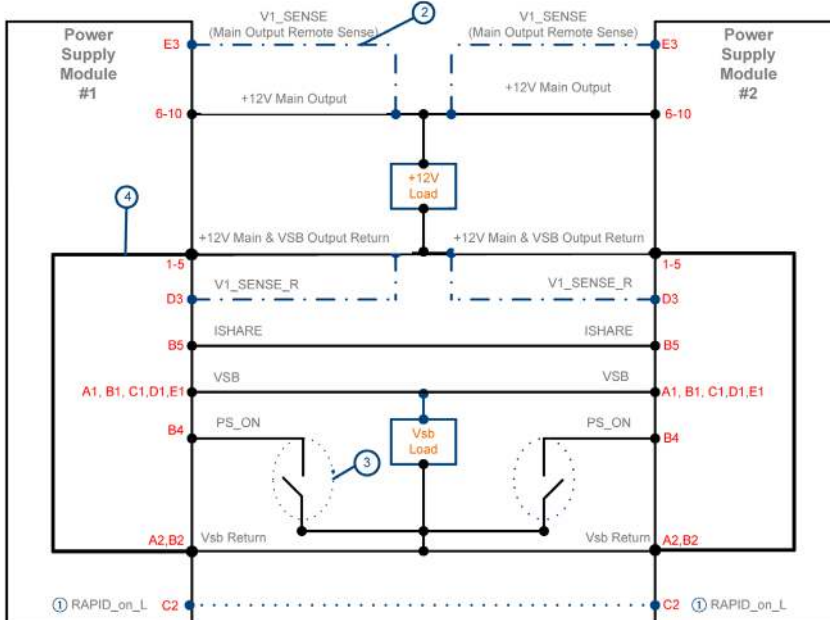

Current Sharing Notes:

1. Main Output current sharing is achieved using the active current share method.
2. Current sharing functions with or without connection of the remote V_SENSE to the common load.
3. +VSB Outputs can be tied together for redundancy however combined output power must not exceed the rated standby power of a single unit. The +VSB output has an internal ORING MOSFET for additional redundancy/internal short protection.
4. Main Output power of units sharing output power must not exceed the rated output power of a single unit during power up. Load can be increased after the PW_OK signal changes to logic "high" state indicating steady state operation.
5. ISHARE pin B5 is connected between sharing units (forming an ISHARE bus). It is an input and/or an output (bi-directional analog bus) as the voltage on the line controls the current share between sharing units. A power supply will respond to a change in this voltage but a power supply can also change the voltage depending on the load drawn from it. On a single unit the voltage on the pin (and the common ISHARE bus would read approximately 8VDC at 100% load. For two units sharing the same load this would read approximately 4VDC for perfect current sharing (i.e. 50% load per unit). This bus is utilized by the Power Supply Module as method of detecting when to change redundancy status when operating in cold redundant mode.

① Pin C2 shown here configured for "RAPID_On" (Cold Redundant bus). For applications requiring an INPUT_OK signal (default setting), refer to "Status and Control Signals" table for details
 ② Dotted lines show optional remote sense connections. Optional remote sense lines can be attached to a load that is a distance away from the power supply to improve regulation at the load.
 ③ FET, BJT, wire or switch (debounced) to turn on +12V Main Output
 ④ Vsb Return is internally connected to main 12V output return within the power supply module

MECHANICAL OUTLINES

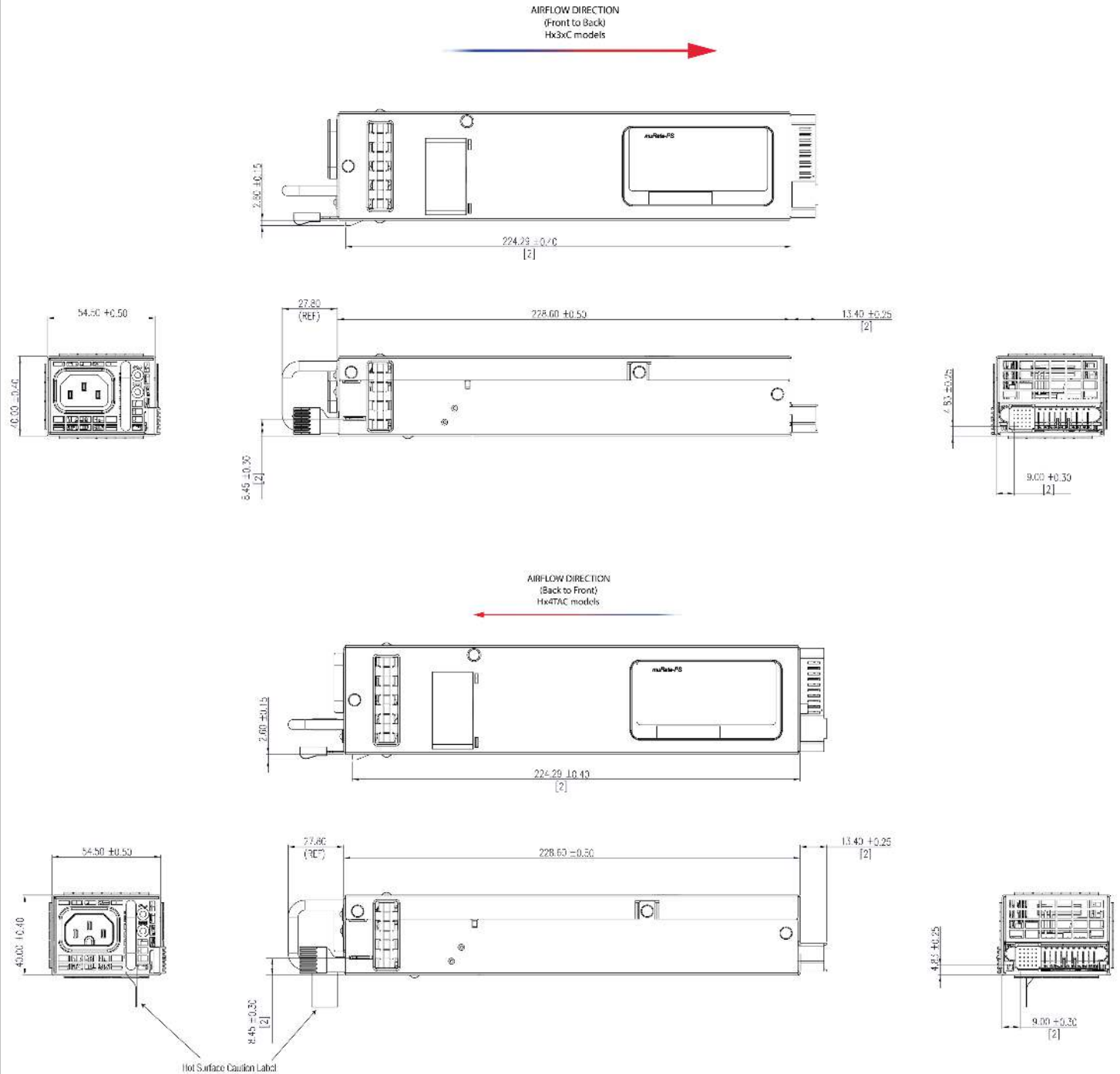

Notes:

- 1) Not all fine details of actual product are shown and the features of the actual product may vary in appearance. This is only a graphical representation intended to facilitate system design. Internal but visible part features such as screw head patterns (Phillips and TORX may be used interchangeably), plastic part details may differ as well, such as logos, molding marks and features for items that may be visible but inside the envelop such as the fan, connector, handle and latch. For purposes of incoming QA inspection, It is recommended a golden sample be retained for comparison.
- 2) Drawing NTS
- 3) Front-Back Airflow models equipped with IEC 60320-C14 input socket; Back-Front Airflow models are equipped with IEC 60320-C16 input socket

OPTIONAL ACCESSORIES

Description	Part Number
12V D1U54P Output Connector Card	D1U54P-12-CONC

APPLICATION NOTES

Document Number	Description	Link
ACAN-64	D1U54P Output Connector Card	URL Link: click to open document
ACAN-113	PMBus Protocol	URL Link: click to open document
ACAN-112	Cold Redundancy Application Notes	URL Link: click to open document

Murata Power Solutions, Inc.
129 Flanders Rd. Westborough,
Ma 01581, USA.
ISO 9001 REGISTERED



This product is subject to the following operating requirements and the Life and Safety Critical Application Sales Policy. Refer to: <https://www.murata-ps.com/requirements/>

Murata Power Solutions, Inc. ("Murata") makes no representation that the use of its products in the circuits described herein, or the use of other technical information contained herein, will not infringe upon existing or future patent rights. The descriptions contained herein do not imply the granting of licenses to make, use, or sell equipment constructed in accordance therewith. Buyer represents and agrees that it has all the necessary expertise to create and implement safeguards that anticipate dangerous consequences of failures, monitor failures and their consequences, lessen the likelihood of failures that might cause harm, and take appropriate remedial actions. Buyer will fully indemnify Murata, its affiliated companies, and its representatives against any damages arising out of the use of any Murata products in safety-critical applications. Specifications are subject to change without notice.

© 2021 Murata Power Solutions, Inc.