



3RHP Series AC Control

- 100K-cycle UL508 Endurance Rating for Enhanced Reliability
- 40 and 50A output
- Voltage ratings to 600 VAC
- Lifetime 2 million operations at full load
- LED input status indicator
- Wire, lug or quick connect termination
- Industry Standard DP contactor mounting

PRODUCT SELECTION (by control voltage and output rating)

Control Voltage	40A 280 VAC	50A 280 VAC	40A 600 VAC	50A 600 VAC
20-26 VAC	3RHP2840E	3RHP2850E	3RHP6040E	3RHP6050E
100-130 VAC	3RHP2840F	3RHP2850F	3RHP6040F	3RHP6050F
208-240 VAC	3RHP2840G	3RHP2850G	3RHP6040G	3RHP6050G

OUTPUT SPECIFICATIONS (voltage)

Description	280 VAC	600 VAC
Operating Voltage (47-63Hz) [Vrms]	24-280	48-600
Maximum Off-State Leakage Current per channel	0.05 mA @ 240 VAC	0.06 mA @ 480 VAC

OUTPUT SPECIFICATIONS (current)

Description	25 A	50 A
Maximum Load Current per phase @ 40°C [Arms] (1)	40A Resistive	50A Resistive
Power terminals	1/4" Quick Connect and 10x32 binder head screws	1/4" Quick Connect and box lugs
Wire Size	8-14 AWG	6-14 AWG

INPUT SPECIFICATIONS

Description	SUFFIX E	SUFFIX F	SUFFIX G
Coil Voltage [50/60 Hz]	20-26 VAC	100-130 VAC	208-240 VAC
Min. Turn-On Voltage	20 VAC	100 VAC	208 VAC
Min. Turn-Off Voltage	12 VAC	24 VAC	48 VAC
Coil Power Consumption, inrush.	56 VA @ 24 VAC	56 VA @ 120 VAC	56 VA @ 220 VAC
Coil Power Consumption, sealed.	6.6 VA @ 24 VAC	6.6 VA @ 120 VAC	6.6 VA @ 220 VAC

GENERAL SPECIFICATIONS

Description	Parameters
Dielectric Strength, Input to Output	4000 Vrms
Dielectric Strength, Input/Output to ground	2500 Vrms
Contacts (2)	Three Normally Open
Ambient Operating Temperature Range (3)	-20 to 65 °C
Ambient Storage Temperature Range	-40 to 100 °C
Max. Turn-On Time 50/60 Hz	20 ms / 16.6 ms
Max. Turn-On Time 50/60 Hz	40 ms / 32 ms
Maximum Number of Operations	30 per Minute
Lifetime Number of Operations @ Rated Current (4)	>2 Million
Weight (typical)	1.19 lbs (540 g)
Screw Torque (input/output) 40A	4.4-5 in lb (0.5-0.6 Nm) / 15-18 in lb (1.7-2.1 Nm)
Screw Torque (input/output) 50A	4.4-5 in lb (0.5-0.6 Nm) / 20-25 in lb (2.2-2.9 Nm)

GENERAL NOTES

- (1) See Derating curves for additional operating conditions.
- (2) The RHP includes a Solid State Relay, therefore electrical isolation is not provided.
- (3) The RHP includes over temperature protection for the solid state relay
- (4) 40°C ambient temperature, 30 operations/min, maximum voltage control.

MECHANICAL SPECIFICATIONS

Tolerances: ±0.02 in / 0.5 mm
All dimensions are in: inches [millimeters]

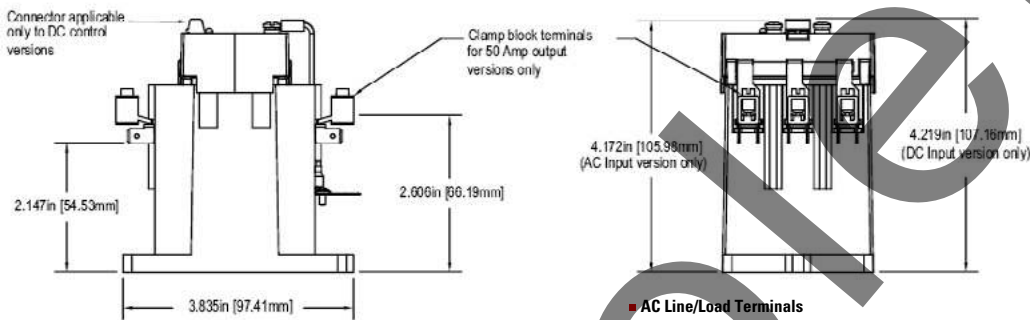
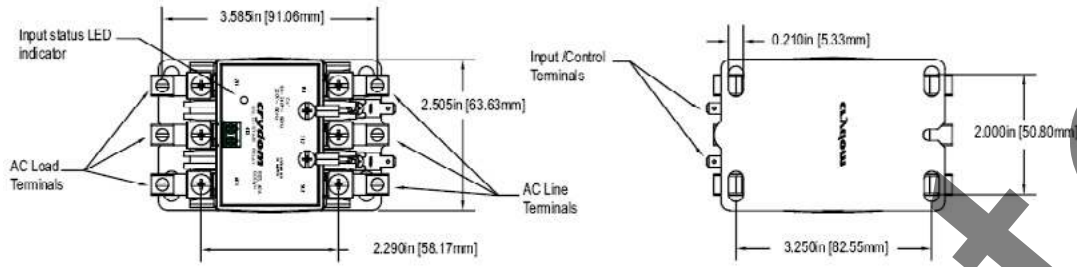

- **AC Line/Load Terminals**
#10-32 screw or .25in x .032in Dual Fast-On
(Box lugs available on 50 Amps version only)
- **Input/Control Terminals**
#8-32 screw or .25in x .032in Fast-On

MECHANICAL SPECIFICATIONS

3RHPXX40XX

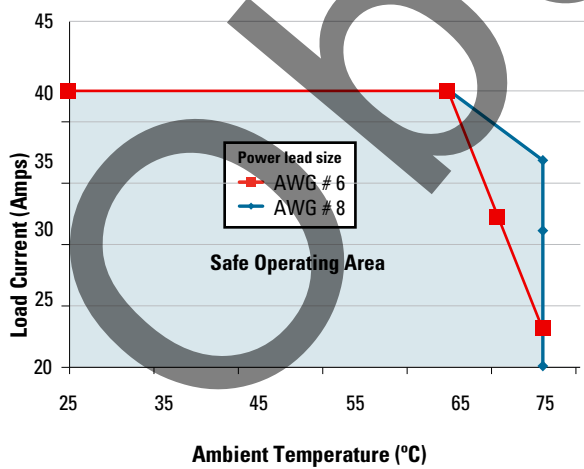

3RHPXX50XX

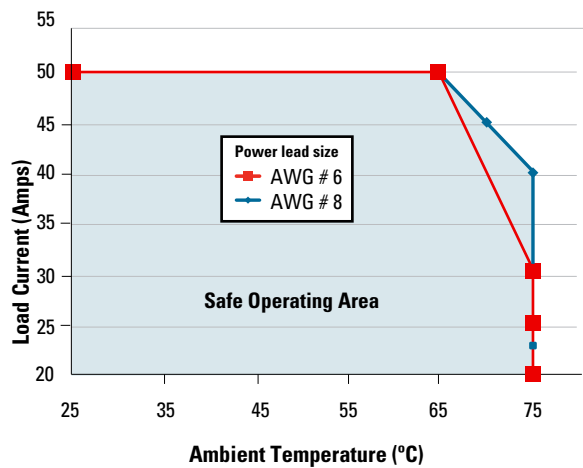

TYPICAL ELECTRICAL CONNECTIONS

Typical Electrical Connection for 3 Phase Applications ①

(For output voltage options 24, 28, 60)

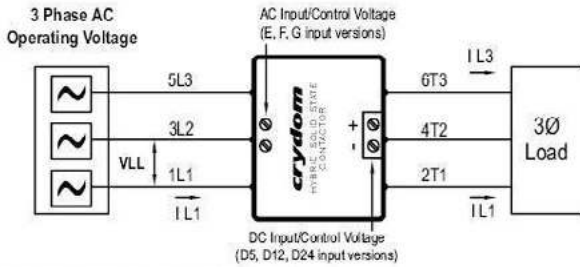

DO NOT apply any AC voltage to DC contactor coil connections

Optional Electrical Connections for Single Phase Applications ②

(For output voltage options 12, 24, 28, 60)

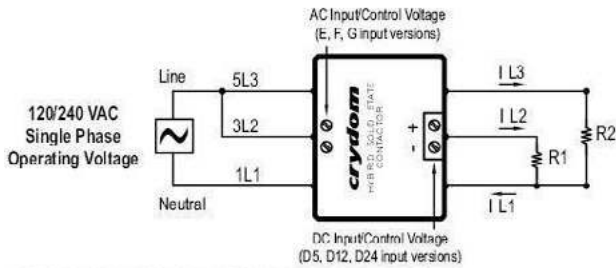

DO NOT apply any AC voltage to DC contactor coil connections

$$I_{L1} = (I_{L2} + I_{L3}) \leq \text{Rated current}$$

- ① Match VLL to voltage suffixes 28 & 60 for options E, F & G and 12 & 24 for options D, X.
- ② The single phase supply voltage must be wired to terminal 1L1 and 3L2 for proper single phase operation.
- ③ In applications switching two single phase loads (R1 and R2) where the combined load current exceeds the contactor's rating (40 or 50 Amps) the return/neutral lead must not be wired through the contactor (see above drawing).

Caution: Risk of overheating. Do not allow any single phase connection to exceed the current rating of the relay. Failure to follow these instructions may result in equipment damage.

Optional Electrical Connections for Single Phase Applications ③

(For output voltage options 12, 24, 28, 60)

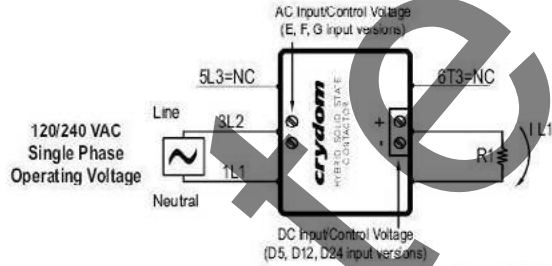

DO NOT apply any AC voltage to DC contactor coil connections

$$I_{L1} \leq \text{Rated current}$$

Optional Electrical Connections for Single Phase Applications ④

(For output voltage options 12, 24, 28, 60)

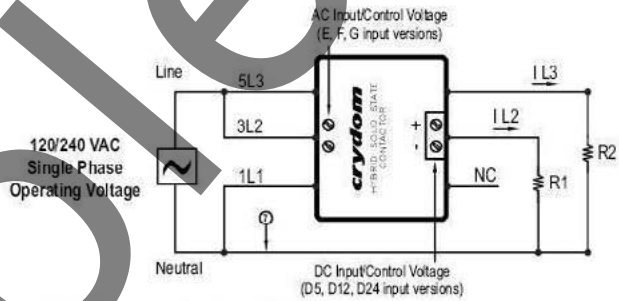

DO NOT apply any AC voltage to DC contactor coil connections

$$I_{L2} \leq \text{Rated current}$$

$$I_{L3} \leq \text{Rated current}$$

$$I_{L2} + I_{L3} > \text{Rated current}$$

AGENCY APPROVALS

AGENCY APPROVALS

UL/cUL UL5 E08, 116950

CE EN60950-1-2006

ACCESSORIES

Accessories



DIN rail bracket

Part Number DMB3

Description DIN Rail mounting adaptor kit



Auxiliary contact

HAC1

Includes one normally open & one normally closed contact, each rated @ 5 Amps rms, 600 VAC, 50/60 Hz 2.5 in Quick Connect

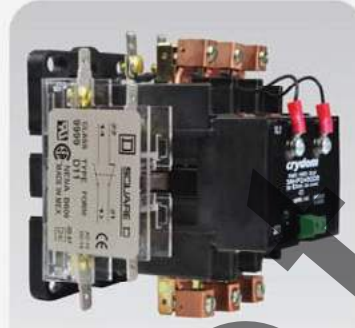

Mounted auxiliary contact

Note: 3RHP accommodates one or two HAC1 auxiliary contacts



Mounted DIN rail bracket

Obsole

⚠ DANGER / PELIGRO / DANGER /GEFAHR / PERICOLO / 危險

<p>HAZARD OF ELECTRIC SHOCK, EXPLOSION, OR ARC FLASH.</p> <ul style="list-style-type: none"> • Disconnect all power before installing or working with this equipment. • Verify all connections and replace all covers before turning on power. <p>Failure to follow these instructions will result in death or serious injury.</p>	<p>RIESGO DE DESCARGA ELECTRICA O EXPLOSION.</p> <ul style="list-style-type: none"> • Desconectar todos los suministros de energia a este equipo antes de trabajar con este equipo. • Verificar todas las conexiones y colocar todas las tapas antes de energizar el equipo. <p>El incumplimiento de estas instrucciones puede provocar la muerte o lesiones serias.</p>	<p>RISQUE DE DESCARGE ELECTRIQUE OU EXPLOSION</p> <ul style="list-style-type: none"> • Eteindre toutes les sources d'énergie de cet appareil avant de travailler dessus de cet appareil • Vérifier tous connections, et remettre tous couverts en place avant de mettre sous <p>De non-suivi de ces instructions provoquera la mort ou des lésions sérieuses.</p>	<p>GEFAHR EINES ELEKTRISCHE N SCHLAGES ODER EINER EXPLOSION.</p> <ul style="list-style-type: none"> • Stellen Sie jeglichen Strom ab, der dieses Gerät versorgt, bevor Sie an dem Gerät Arbeiten durchführen • Vor dem Drehen auf Energie alle Anschlüsse überprüfen und alle Abdeckungen ersetzen. <p>Unterlassung dieser Anweisungen können zum Tode oder zu schweren Verletzungen führen.</p>	<p>RISCHIO DI SCOSSA ELETTRICA O DELL'ESPLOSIONE.</p> <ul style="list-style-type: none"> • Spenga tutta l'alimentazione che fornisce questa apparecchiatura prima di lavorare a questa apparecchiatura • Verificare tutti i collegamenti e sostituire tutte le coperture prima dell'accensione <p>L'omissione di queste istruzioni provocherà la morte o lesioni serie</p>	<p>存在电击、爆炸或电弧闪烁危险</p> <ul style="list-style-type: none"> • 在操作此设备之前请先关闭电源。 <p>若不遵守这些说明，可能会导致严重的人身伤害甚至死亡。</p>
--	--	---	--	--	---

⚠ WARNING / AVERTISSEMENT / WARNUNG / ADVERTENCIA / AVVERTENZA / 警告

<p>RISK OF MATERIAL DAMAGE AND HOT ENCLOSURE</p> <ul style="list-style-type: none"> • The product's side panels may be hot, allow the product to cool before touching. • Follow proper mounting instructions including torque values. • Do not allow liquids or foreign objects to enter this product. <p>Failure to follow these instructions can result in serious injury, or equipment damage.</p>	<p>RISQUE DE DOMMAGE MATERIEL ET DE SURCHAUFFE DU BOITIER</p> <ul style="list-style-type: none"> • Les panneaux latéraux du produit peuvent être chauds. Laisser le produit refroidir avant de le toucher. • Respecter les consignes de montage, et notamment les couples de serrage. • Ne pas laisser pénétrer de liquide ni de corps étrangers à l'intérieur du produit. <p>Le non-respect de cette directive peut entraîner, des lésions corporelles graves ou des dommages matériels.</p>	<p>GEFAHR VON MATERIALSCHÄDEN UND GEHÄUSEERHITZUNG</p> <ul style="list-style-type: none"> • Die Seitenwände können heiß sein. Lassen Sie das Produkt abkühlen, bevor Sie es berühren. • Beachten Sie die Montageanweisungen, • Führen Sie keine Flüssigkeiten oder Fremdkörper in das Produkt ein. <p>Die Nichtbeachtung dieser Anweisung kann Körperverletzung oder Materialschäden zur Folge haben.</p>
<p>RIESGO DE DAÑOS MATERIALES Y DE SOBRECIENTAMIENTO DE LA UNIDAD</p> <ul style="list-style-type: none"> • Los paneles laterales del producto pueden estar calientes. Esperar que el producto se enfríe antes de tocarlo. • Respetar las instrucciones de montaje, y en particular los pares de apretado. • No dejar que penetren líquidos o cuerpos extraños en el producto. <p>Si no se respetan estas precauciones pueden producirse graves lesiones, daños materiales.</p>	<p>RISCHIO DI DANNI MATERIALI E D'INVOLUCRO CALDO</p> <ul style="list-style-type: none"> • I pannelli laterali dell'apparecchio possono scottare; lasciar quindi raffreddare il prodotto prima di toccarlo. • Seguire le istruzioni di montaggio corrette. • Non far entrare liquidi o oggetti estranei in questo apparecchio. <p>La mancata osservanza di questa precauzione può causare gravi rischi per l'incolumità personale o danni alle apparecchiature.</p>	<p>材料损坏和高温外壳的危险性</p> <ul style="list-style-type: none"> • 产品的一侧面板可能很热，在其冷却前请不要触碰。 • 遵照正确的安装说明，包括扭矩值。 • 请勿让液体及其他异物进入本产品。 <p>如不能正确执行这些操作说明，极有可能造成严重人体伤害或者设备的损坏。</p>

ANNEX - ENVIROMENTAL INFORMATION

The environmental information disclosed in this annex including the EIP Pollution logo are in compliance with People’s Republic of China Electronic Industry Standard SJ/T11364 – 2006, Marking for Control of Pollution Caused by Electronic Information Products.

Part Name	Toxic or hazardous Substance and Elements					
	Lead (Pb)	Mercury (Hg)	Cadmium (Cd)	Hexavalent Chromium (Cr (VI))	Polybrominated biphenyls (PBB)	Polybrominated diphenyl ethers (PBDE)
Semiconductor die	X	○	○	○	○	○
Solder	X	○	○	○	○	○

附件 - 环保信息

此附件所标示的包括电子信息产品污染图标的环保信息符合中华人民共和国电子行业标准 SJ/T11364 - 2006, 电子信息产品污染控制标识要求。

部件名称	有毒有害物质或元素					
	铅 (Pb)	汞 (Hg)	镉 (Cd)	六价铬 (Cr (VI))	多溴联苯 (PBB)	多溴二苯醚 (PBDE)
半导体芯片	X	○	○	○	○	○
焊接点	X	○	○	○	○	○

