



# EV3437-RP-00A

## High Efficiency, Fully-Integrated Synchronous Boost Converter EV Board

### DESCRIPTION

EV3437-RP-00A Evaluation Board is designed to demonstrate the capability of MP3437. It is a 600kHz fixed frequency, wide input range, highly integrated boost converter. It starts from an input voltage as low as 2.7V, and supports up to 20W load power from 1-cell battery.

MP3437 adopts constant-off-time (COT) control topology providing fast transient response. QFN package has MODE pin which can support mode selection of PSM, FCCM and USM in light load condition. And the integrated low-side and high-side MOSFET simplify the design and save BOM cost.

The MP3437 supports auto-pass-through mode when  $V_{IN}$  is higher than  $V_{OUT-SET}$  in PSM mode. It also features with programmable input under-voltage lockout (UVLO) and over temperature protection.

The MP3437 is available in QFN-10 (2mmx2.5mm) and TSOT23-8 package. This board is available in QFN-10 package.

### ELECTRICAL SPECIFICATION

Parameter	Symbol	Value	Units
Input Voltage	$V_{IN}$	2.7-16	V
Output Voltage	$V_{OUT}$	8	V
Output Current	$I_{OUT}$	2.5	A

### FEATURES

- 2.7V-to-16V Startup Voltage<sup>(1)</sup>
- 0.8V-to-16V Operation Voltage
- Up to 16V Output Voltage
- Support 20W Power Load from 3.3V
- 9.5A Internal Switch Current Limit
- Integrated 14mΩ & 21mΩ Power MOSFET
- >90% Efficiency for 3.3V VIN to 8V/2.5A
- Auto Pass-Through Function in PSM Mode
- 600kHz Fixed Switching Frequency
- Adaptive COT for Fast Transient Response
- Internal Soft Start and Compensation
- Programmable UVLO and Hysteresis
- 150°C Over Temperature Protection
- Over Voltage Protection
- QFN-10 Package on This Board

### APPLICATIONS

- Notebook
- AI Speaker
- Bluetooth Speaker
- Portable POS System

All MPS parts are lead-free, halogen free, and adhere to the RoHS directive. For MPS green status, please visit MPS website under Quality Assurance. "MPS" and "The Future of Analog IC Technology" are Registered Trademarks of Monolithic Power Systems, Inc.

**Note:**

(1) During input power on, the inrush current through high-side MOSFET body diode should be limited less than 30A. And the continuous current should be avoided to flow through high-side MOSFET body diode. Refer to "Input Power-up Inrush Current Control" section in MP3437 datasheet for detail.

### EV3437-RP-00A EVALUATION BOARD



(L x W x H) 6.4cm x 6.4cm x 0.6cm

Board Number	MPS IC Number
EV3437-RP-00A	MP3437GRP

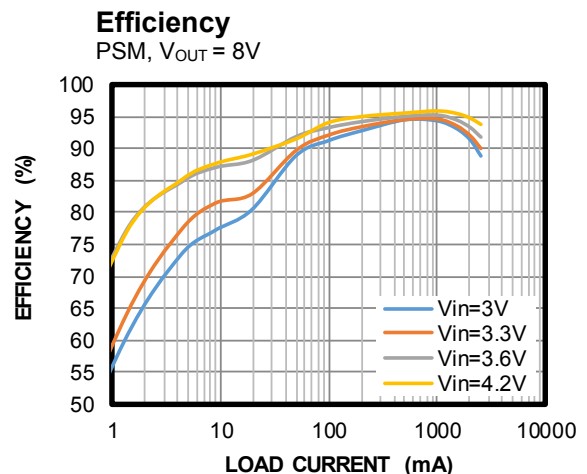

### EVALUATION BOARD SCHEMATIC

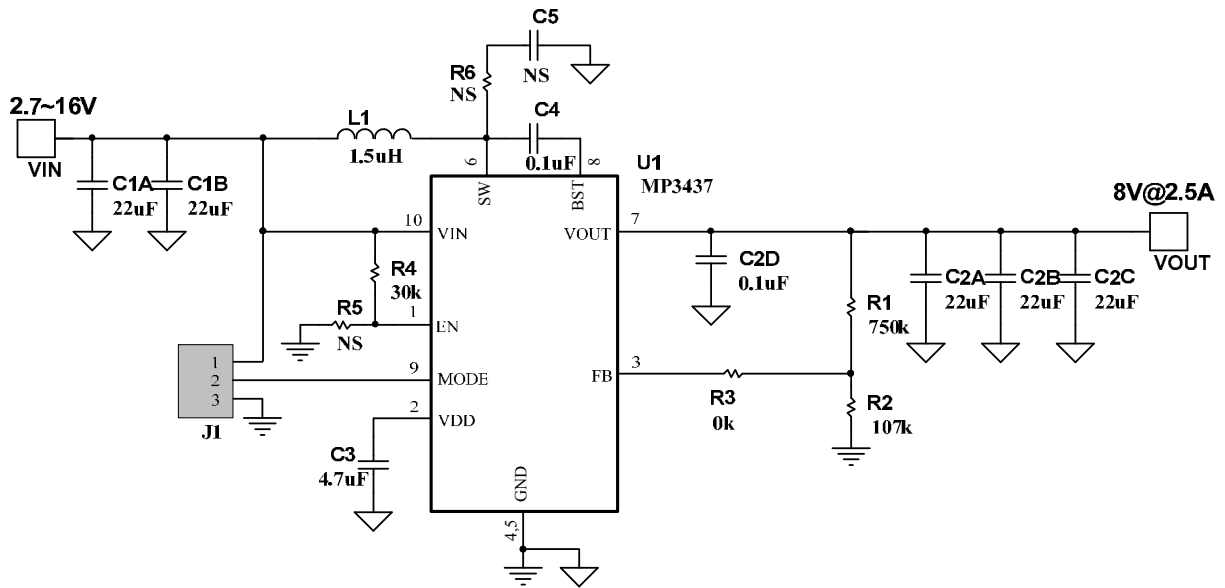

**EV3437-RP-00A BILL OF MATERIALS**

Qty	Ref	Value	Description	Package	Manufacturer	Manufacturer P/N
5	C1A,C1B C2A,C2B, C2C	22µF	Ceramic Cap.,25V,X7R	1210	Murata	GRM32ER71E226KE 20L
1	C2D	100nF	Ceramic Cap.,25V,X7R	0805	Murata	GRM21BR71E104KA 01L
1	C3	4.7µF	Ceramic Cap.,16V,X7R	0603	Murata	GRM188Z71C475KE 21D
1	C4	100nF	Ceramic Cap.,25V,X7R	0402	Murata	GRM155R71E104KA 88D
1	R1	750K	Film Res,1%	0603	YAGEO	RC0603FR-07750KL
1	R2	107K	Film Res,1%	0603	YAGEO	RC0603FR-07107KL
1	R3	0R	Film Res,1%	0603	YAGEO	RC0603FR-070RL
1	R4	30K	Film Res,1%	0603	YAGEO	RC0603FR-0730KL
0	R5, R6, C5	NS				
1	L1	1.5µH	Inductor, RDC=8.6mOhm, Isat=14.5A	SMD	Wruth	74437349015
1	J1	JUMPER	Jumper,1*3Pins	DIP	WE	60900213421
1	U1	MP3437	16V/9.5A Boost	QFN-10	MPS	MP3437GRP

### EVB TEST RESULTS

$V_{IN} = 3.3V$ ,  $V_{OUT} = 8V$ ,  $L = 1.5\mu H$ ,  $I_{OUT} = 2.5A$ , PSM,  $T_A = 25^\circ C$ , unless otherwise noted.

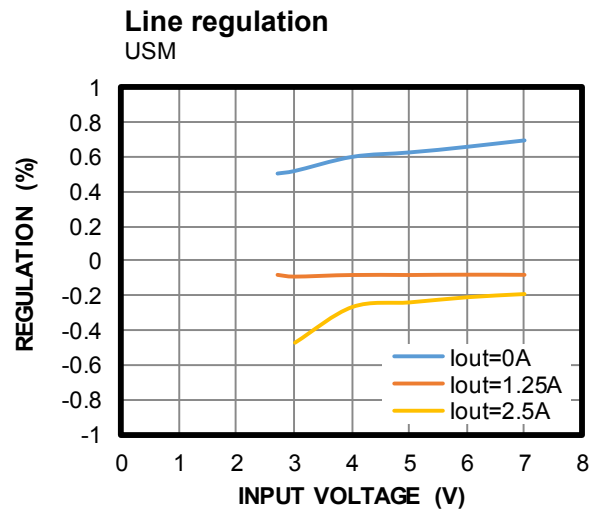
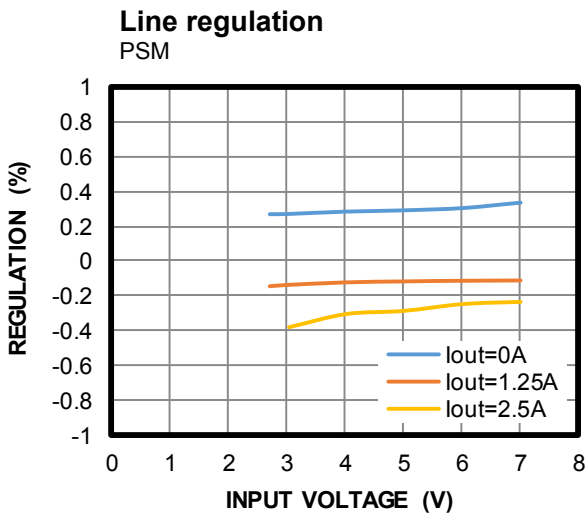
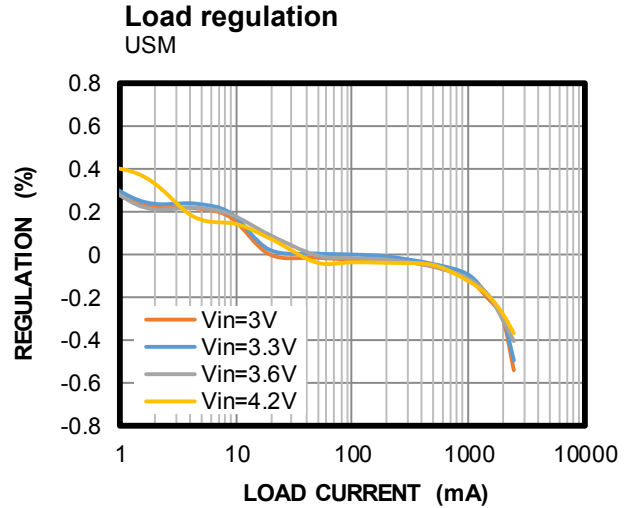
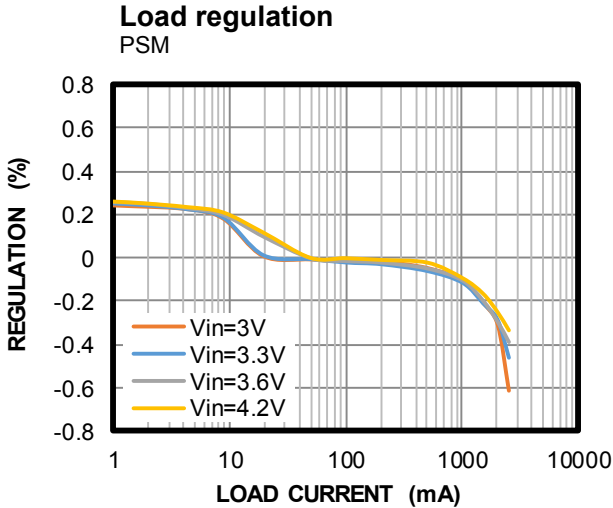
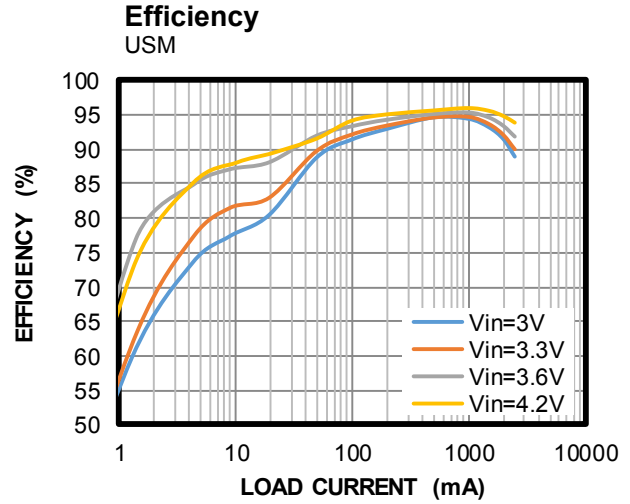
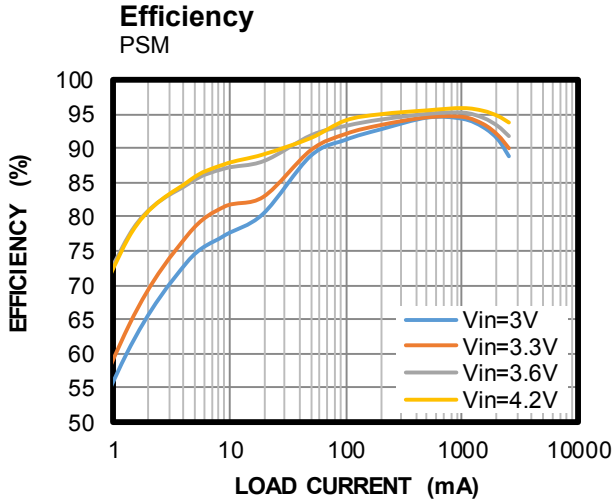

**EVB TEST RESULTS (continued)**

$V_{IN} = 3.3V$ ,  $V_{OUT} = 8V$ ,  $L=1.5\mu H$ ,  $I_{OUT} = 2.5A$ , PSM,  $T_A = 25^\circ C$ , unless otherwise noted.

**Bode Plot**

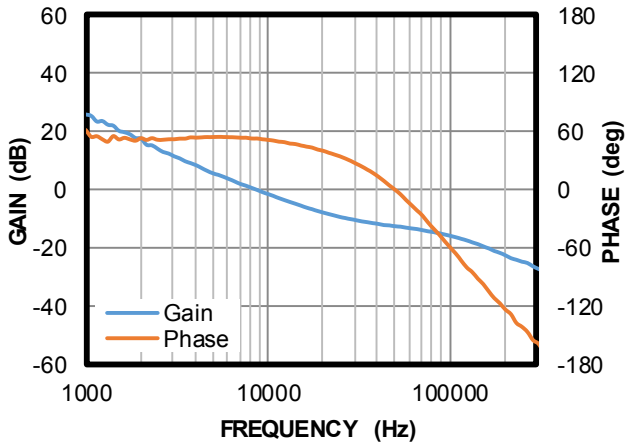

**Case Temperature Rising**

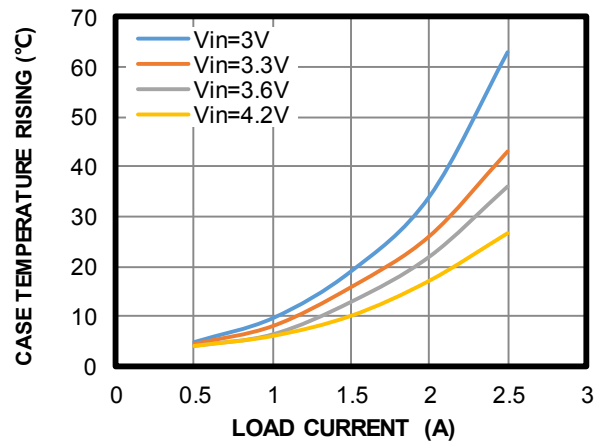

**EVB TEST RESULTS (continued)**

$V_{IN} = 3.3V$ ,  $V_{OUT} = 8V$ ,  $L = 1.5\mu H$ ,  $I_{OUT} = 2.5A$ , PSM,  $T_A = 25^\circ C$ , unless otherwise noted.

**Steady State**

$I_{OUT} = 0A$ , USM

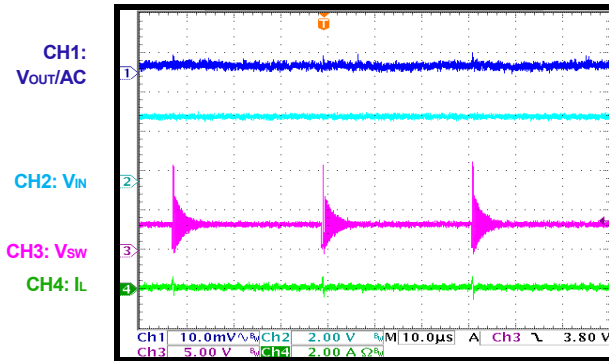

**Steady State**

$I_{OUT} = 0A$ , PSM

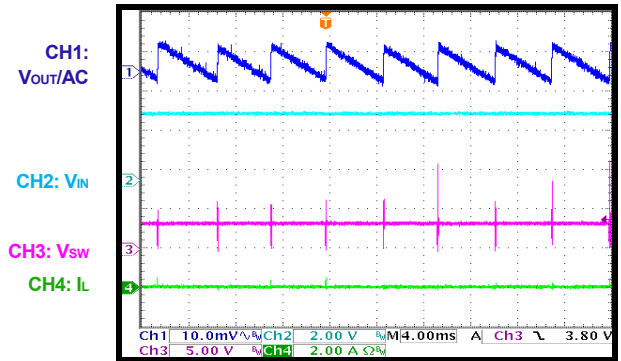

**Steady State**

$I_{OUT} = 0A$ , FCCM

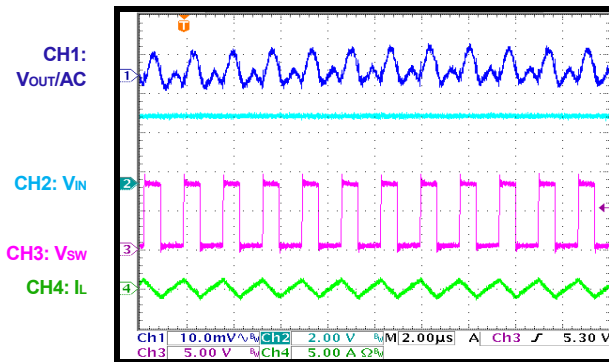

**Steady State**

$I_{OUT} = 2.5A$

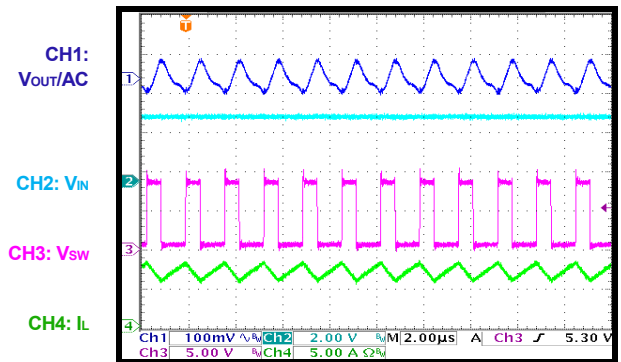

**VIN Start-Up**

$I_{OUT} = 0A$

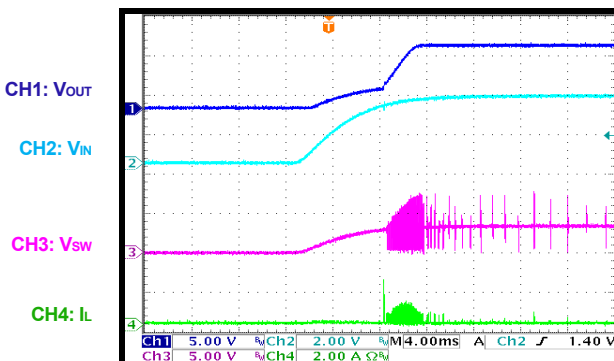

**VIN Start-Up**

$I_{OUT} = 2.5A$

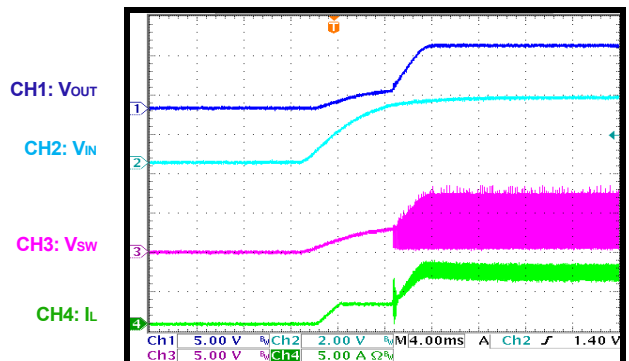

**EVB TEST RESULTS** *(continued)*

$V_{IN} = 3.3V$ ,  $V_{OUT} = 8V$ ,  $L = 1.5\mu H$ ,  $I_{OUT} = 2.5A$ , PSM,  $T_A = 25^\circ C$ , unless otherwise noted.

**VIN Shutdown**

$I_{OUT} = 0A$

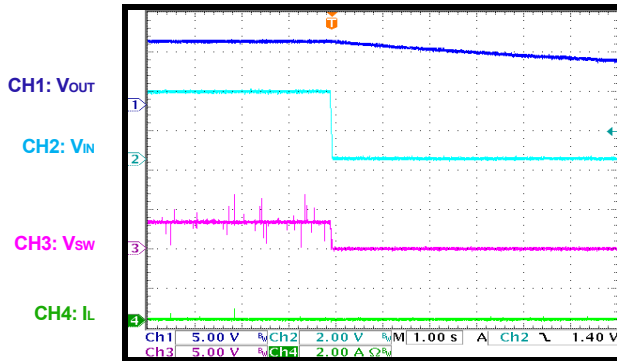

**VIN Shutdown**

$I_{OUT} = 2.5A$

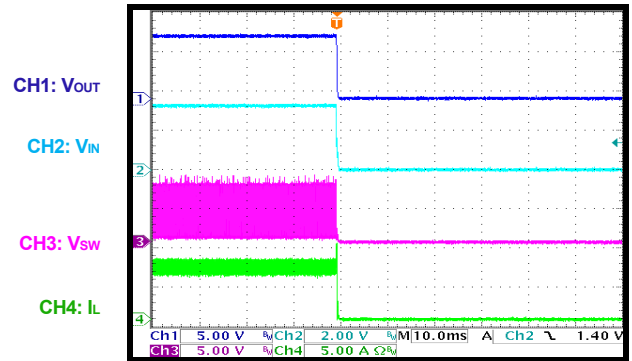

**EN Start-Up**

$I_{OUT} = 0A$

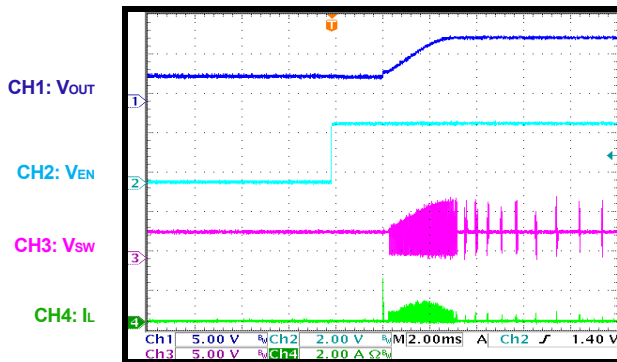

**EN Start-Up**

$I_{OUT} = 2.5A$

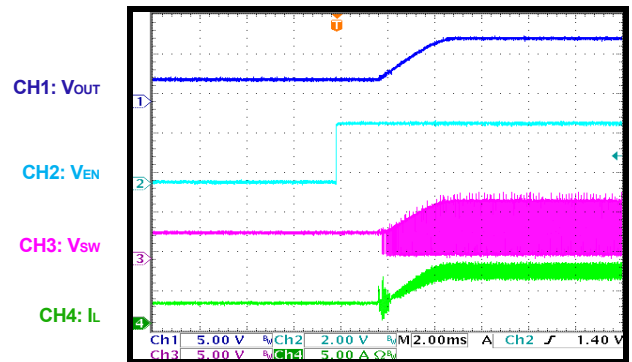

**EN Shutdown**

$I_{OUT} = 0A$

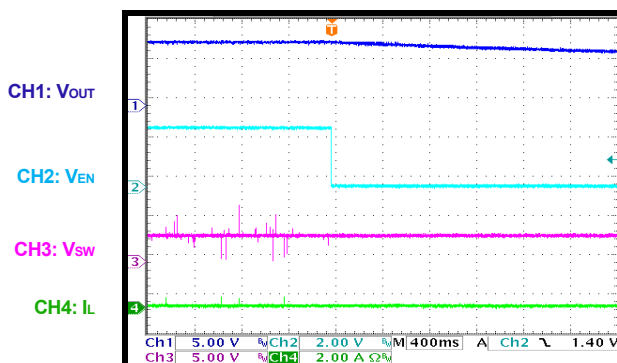

**EN Shutdown**

$I_{OUT} = 2.5A$

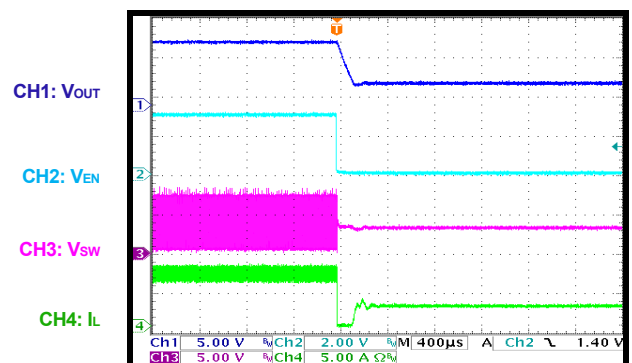

**EVB TEST RESULTS** *(continued)*

$V_{IN} = 3.3V$ ,  $V_{OUT} = 8V$ ,  $L = 1.5\mu H$ ,  $I_{OUT} = 2.5A$ , PSM,  $T_A = 25^\circ C$ , unless otherwise noted.

**Load Transient**  
 $I_{OUT} = 0 - 1.25A$ , USM

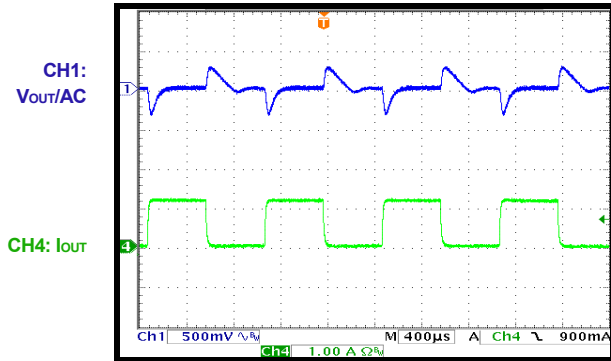

**Load Transient**  
 $I_{OUT} = 1.25 - 2.5A$

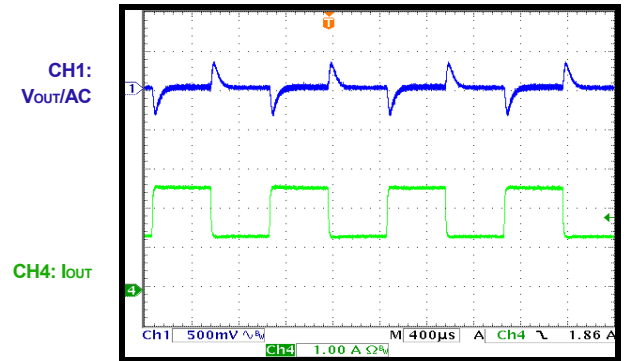

**Load Transient**  
 $I_{OUT} = 0 - 1.25A$ , PSM

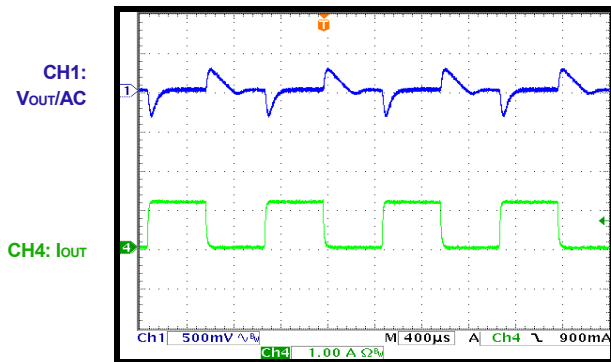

**Load Transient**  
 $I_{OUT} = 0 - 1.25A$ , FCCM

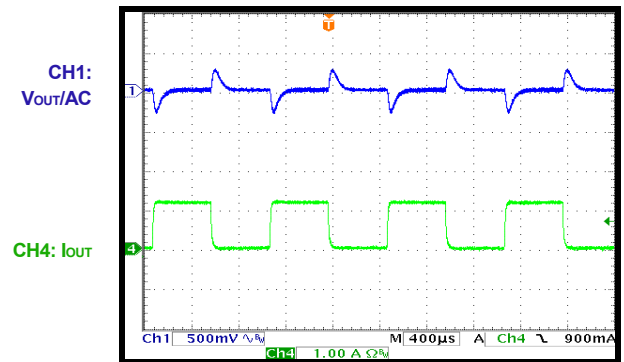

**Over-Current Entry**  
 Increase output current slowly, 0A->4.5A

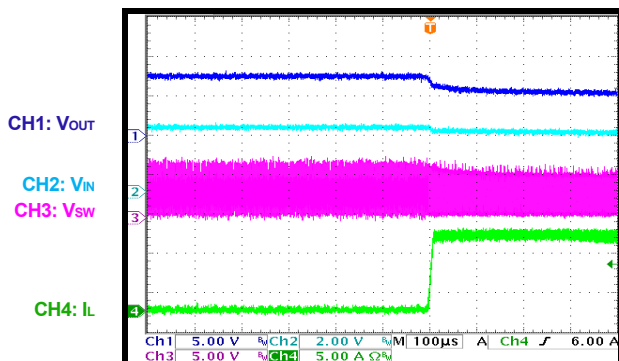

**Over-Current Recovery**  
 Decrease output current slowly, 4.5A->0A

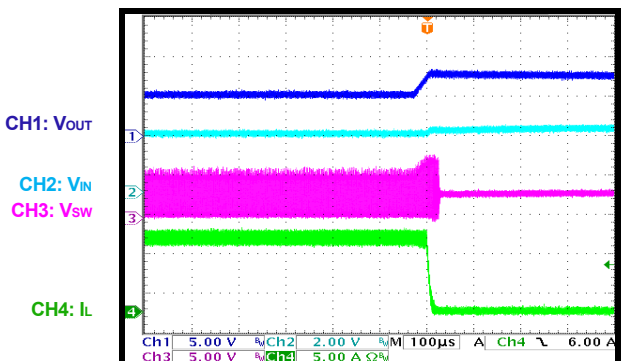



### PRINTED CIRCUIT BOARD LAYOUT

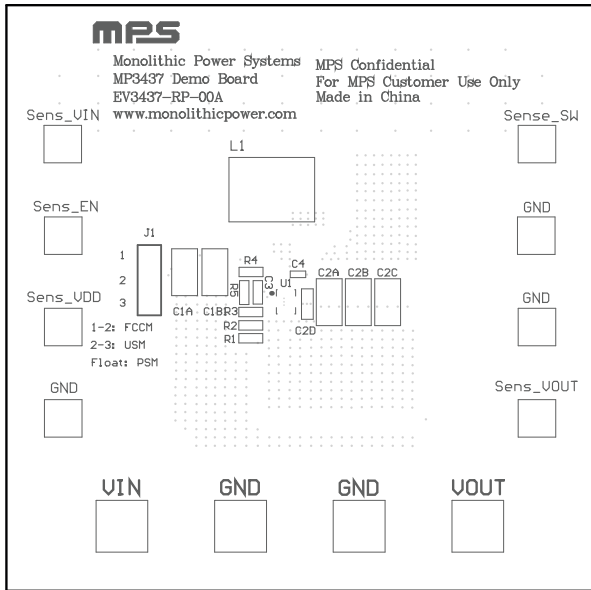

Figure 1: Top Silk

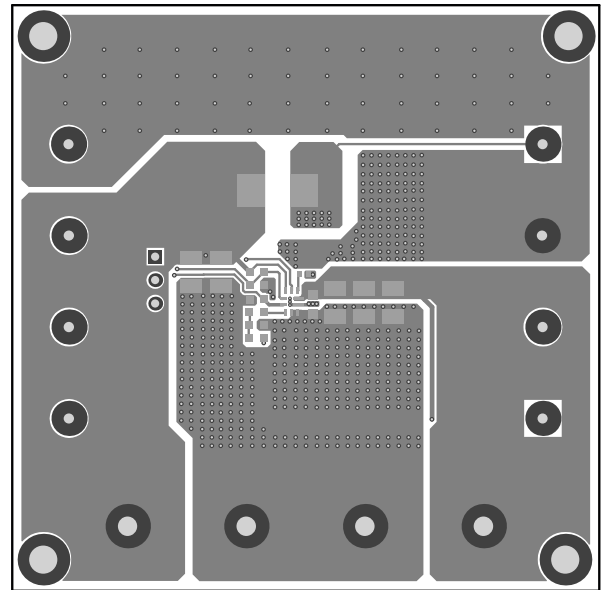

Figure 2: Top Layer

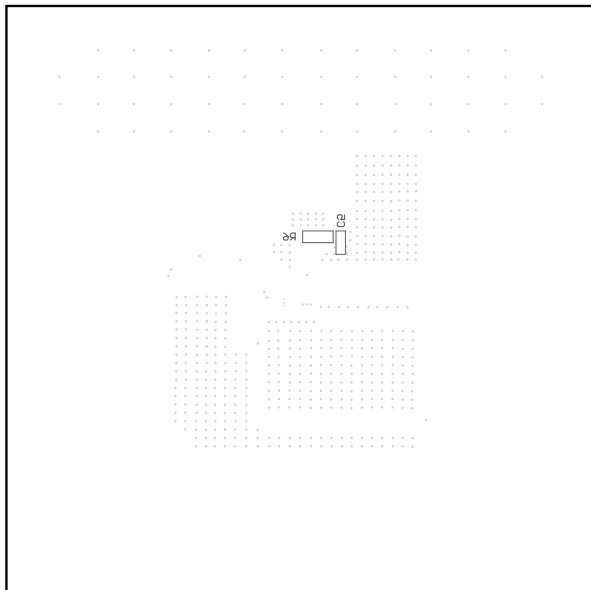

Figure 3: Bottom Silk

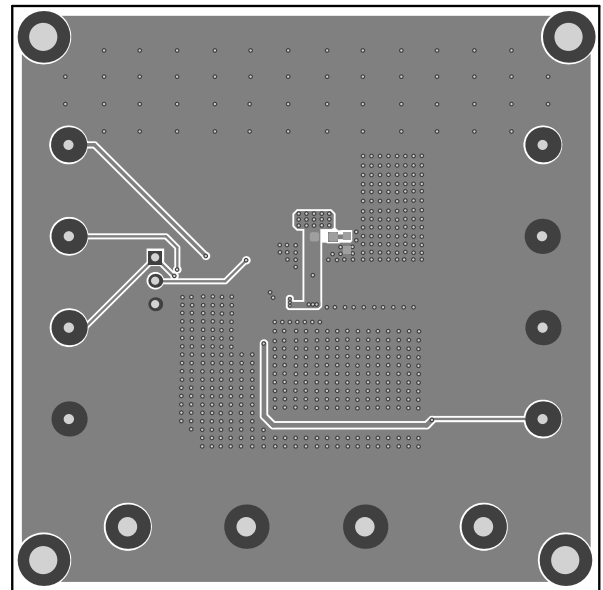

Figure 4: Bottom Layer

## QUICK START GUIDE

The output voltage of this board is set to 8V. The board layout accommodates most commonly used components. Following below steps to quick start EV3437-RP-00A.

1. Preset Power Supply to  $2.7V \leq V_{IN} \leq 16V$ .
2. Turn Power Supply off.
3. Connect Power Supply terminals to:
  - a. Positive (+): VIN
  - b. Negative (-): GND
4. Connect Load to:
  - a. Positive (+): VOUT
  - b. Negative (-): GND
5. Turn Power Supply on after making connections. The inrush current through high-side MOSFET body diode should be limited less than 30A. Refer to “Input Power-up Inrush Current Control” section in MP3437 datasheet for detail.
6. The MP3437 is enabled on the evaluation board once VIN is applied.
7. The output voltage VOUT can be changed by varying R2. Calculate the new value using the formula:

$$V_{OUT} = V_{FB} \times \left(1 + \frac{R1}{R2}\right)$$

Where  $V_{FB} = 1V$  and  $R1=750k\Omega$ . If  $V_{OUT-SET}>15V$ , the RC snubber on SW to GND is recommended, such as  $R6=1\Omega$ ,  $C5=2.2nF$ .

8. If USM and FCCM is needed, following below steps:
  - a. Turn Power Supply off.
  - b. Change J1 connection. Connect 1 to 2 for FCCM, connect 2 to 3 for USM, and float 2 for PSM.
  - c. Turn the power on. IC will work with the mode which is set by step b.
9. If the auto pass-through function is needed, following below steps:
  - a. Set J1 to make MP3437 working in PSM.
  - b. Increasing input voltage much higher than  $V_{OUT-SET}$ , MP3437 will enter auto pass-through automatically.

**NOTICE:** The information in this document is subject to change without notice. Please contact MPS for current specifications. Users should warrant and guarantee that third party Intellectual Property rights are not infringed upon when integrating MPS products into any application. MPS will not assume any legal responsibility for any said applications.