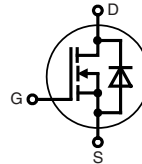
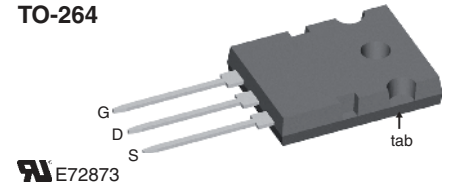

CoolMOS™ 1) Power MOSFET

Low $R_{DS(on)}$, high V_{DSS}
Superjunction MOSFET

$V_{DSS} = 600\text{ V}$
 $I_{D25} = 85\text{ A}$
 $R_{DS(on)\text{ max}} = 36\text{ m}\Omega$

TO-264

MOSFET			
Symbol	Conditions	Maximum Ratings	
V_{DSS}	$T_{VJ} = 25^\circ\text{C}$	600	V
V_{GS}		± 20	V
I_{D25}	$T_C = 25^\circ\text{C}$	85	A
I_{D100}	$T_C = 100^\circ\text{C}$	55	A
E_{AS}	single pulse $I_D = 10\text{ A}; T_C = 25^\circ\text{C}$	1800	mJ
E_{AR}	repetitive $I_D = 20\text{ A}; T_C = 25^\circ\text{C}$	1	mJ
dV/dt	MOSFET dV/dt ruggedness $V_{DS} = 0 \dots 480\text{ V}$	50	V/ns

Features

- 3rd generation CoolMOS™ 1) power MOSFET
- high blocking capability
- lowest resistance
- avalanche rated for unclamped inductive switching (UIS)
- low thermal resistance due to reduced chip thickness

Applications

- Switched mode power supplies (SMPS)
- Uninterruptible power supplies (UPS)
- Power factor correction (PFC)
- Welding
- Inductive heating

Symbol	Conditions	Characteristic Values			
		$(T_{VJ} = 25^\circ\text{C}, \text{ unless otherwise specified})$			
		min.	typ.	max.	
$R_{DS(on)}$	$V_{GS} = 10\text{ V}; I_D = I_{D100}$ ①		30	36	m Ω
$V_{GS(th)}$	$V_{DS} = V_{GS}; I_D = 5.4\text{ mA}$	2		4	V
I_{DSS}	$V_{DS} = V_{DSS}; V_{GS} = 0\text{ V}$			50	μA
	$T_{VJ} = 25^\circ\text{C}$			500	μA
	$T_{VJ} = 125^\circ\text{C}$				
I_{GSS}	$V_{GS} = \pm 20\text{ V}; V_{DS} = 0\text{ V}$			± 200	nA
C_{iss}	$V_{GS} = 0\text{ V}; V_{DS} = 25\text{ V}$ $f = 1\text{ MHz}$		13.6		nF
C_{oss}			4.4		nF
C_{rss}			290		pF
Q_g	$V_{GS} = 0\text{ to }10\text{ V}; V_{DS} = 350\text{ V}; I_D = 85\text{ A}$		500	640	nC
Q_{gs}			50		nC
Q_{gd}			240		nC
$t_{d(on)}$	$V_{GS} = 13\text{ V}; V_{DS} = 380\text{ V}$ $I_D = 85\text{ A}; R_G = 1.0\ \Omega$		20		ns
t_r			27		ns
$t_{d(off)}$			110		ns
t_f			10		ns
R_{thJC}				0.18	K/W

① Pulse test, $t \leq 300\ \mu\text{s}$, duty cycle $d \leq 2\%$

1) CoolMOS™ is a trademark of Infineon Technologies AG.

Source-Drain Diode

Symbol	Conditions	Characteristic Values			
		min.	typ.	max.	
I_S	$V_{GS} = 0\text{ V}$			85	A
I_{SM}				250	A
V_{SD}	$I_F = 85\text{ A}; V_{GS} = 0\text{ V}$			1.2	V
t_{rr}	$I_F = 85\text{ A}; -di_F/dt = 200\text{ A}/\mu\text{s}; V_R = 350\text{ V}$		580		ns
Q_{RM}			46		μC
I_{RM}			140		A

($T_{VJ} = 25^\circ\text{C}$, unless otherwise specified)

Component

Symbol	Conditions	Maximum Ratings		
		min.	typ.	max.
T_{VJ}	operating		-55...+150	$^\circ\text{C}$
T_{stg}			-55...+150	$^\circ\text{C}$
M_d	mounting torque		0.8 ... 1.2	Nm

Symbol	Conditions	Characteristic Values		
		min.	typ.	max.
R_{thCH}	with heatsink compound		0.15	K/W
Weight			10	g

TO-264 Outline

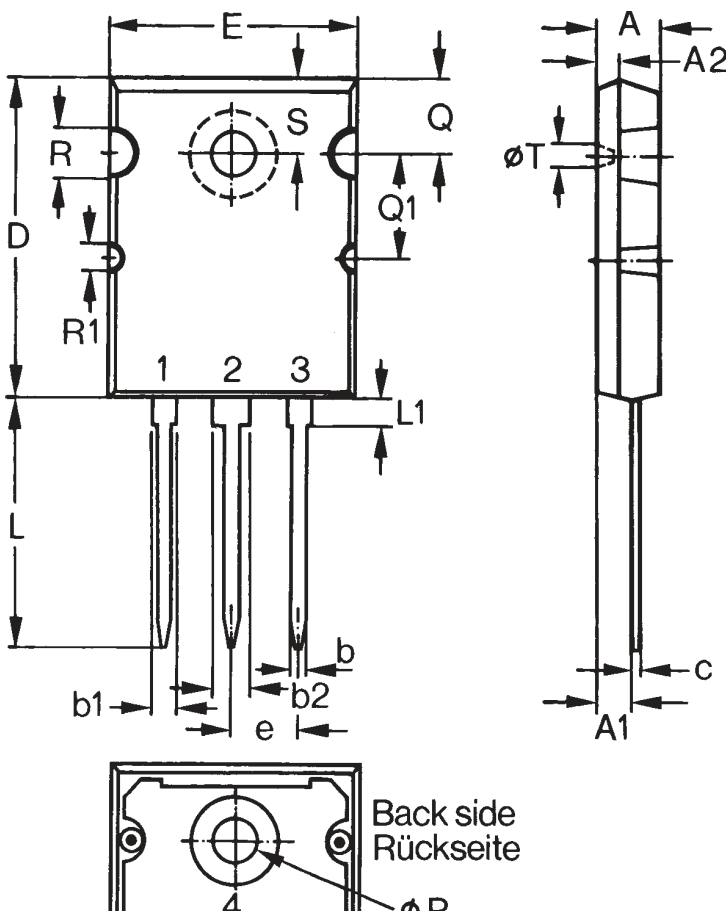

SYM	INCHES		MILLIMETERS	
	MIN	MAX	MIN	MAX
A	.185	.209	4.70	5.31
A1	.102	.118	2.59	3.00
b	.037	.055	0.94	1.40
b1	.087	.102	2.21	2.59
b2	.110	.126	2.79	3.20
C	.017	.029	0.43	0.74
D	1.007	1.047	25.58	26.59
E	.760	.799	19.30	20.29
e	.215 BSC		5.46 BSC	
L	.193	.201	4.90	5.10
L1	.088	.096	2.24	2.44
L2	.075	.083	1.90	2.10
L3	.000	.004	0.00	0.10
ϕP	.122	.138	3.10	3.51
Q	.240	.256	6.10	6.50
Q1	.330	.346	8.38	8.79
ϕR	.155	.187	3.94	4.75
$\phi R1$.085	.093	2.16	2.36
S	.243	.253	6.17	6.43

NOTE 1. This drawing meets all dimension requirement of JEDEC outline TO-264A except L, L1, L2, L3

2. All metal surface are solder patted except trimmed area

Fig. 1. Output Characteristics @ 25 Deg. C

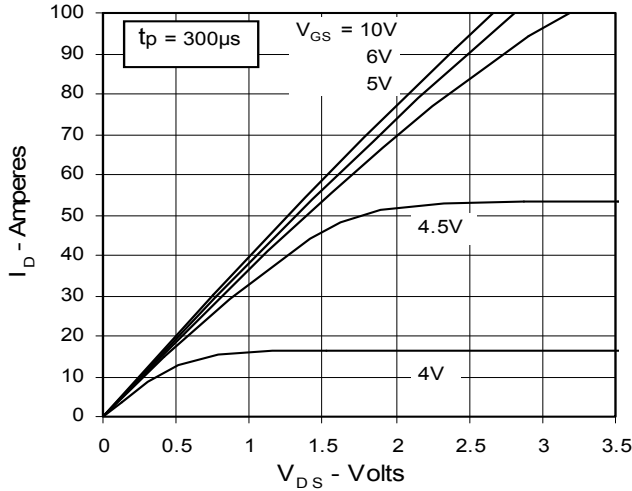

Fig. 2. Extended Output Characteristics @ 25 deg. C

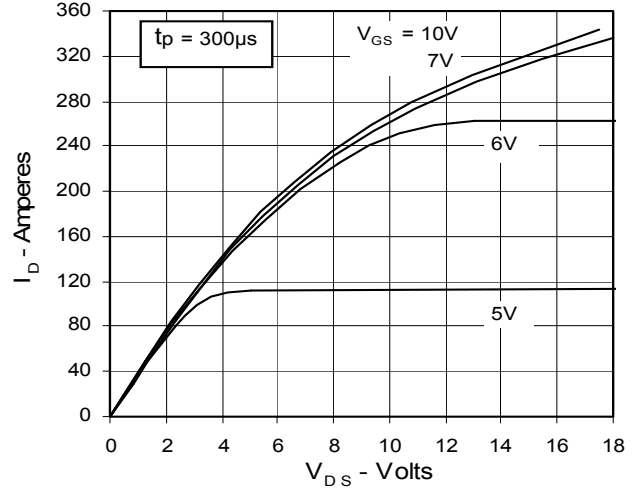

Fig. 3. Output Characteristics @ 125 Deg. C

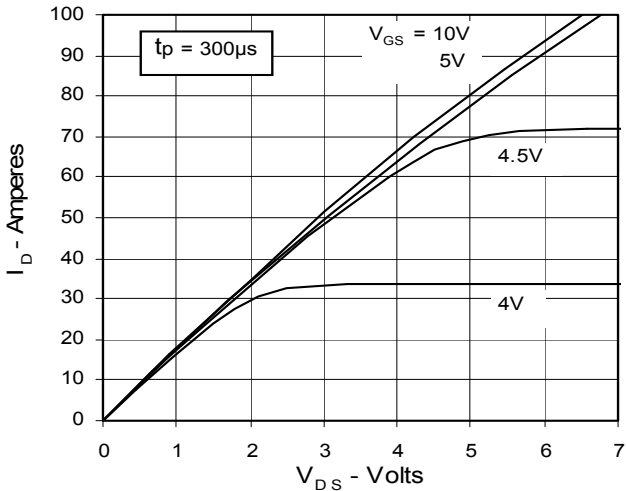

Fig. 4. R_DS(on) Normalized to I_D100 Value vs. Junction Temperature

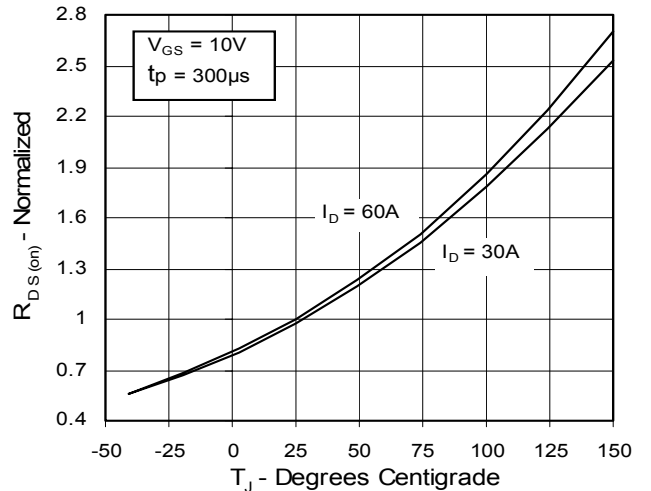

Fig. 5. R_DS(on) Normalized to I_D100 Value vs. I_D

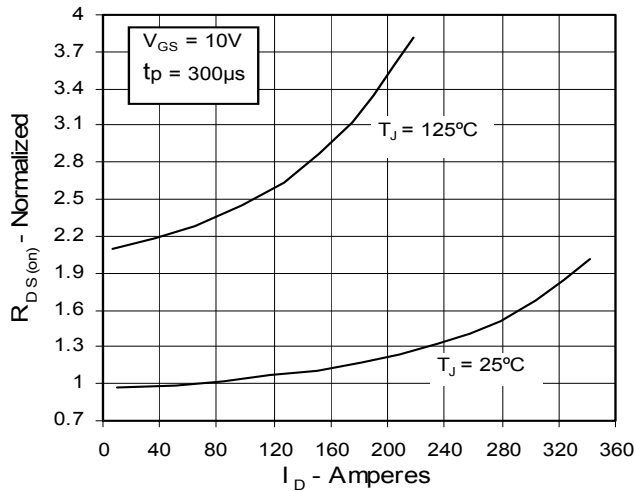

Fig. 6. Drain Current vs. Case Temperature

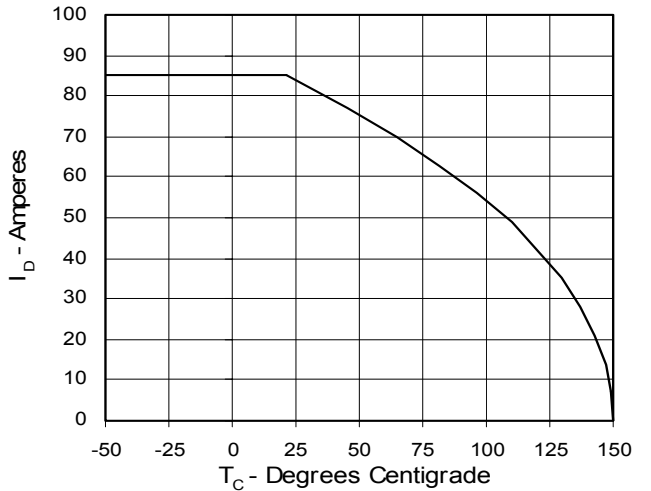

Fig. 7. Input Admittance

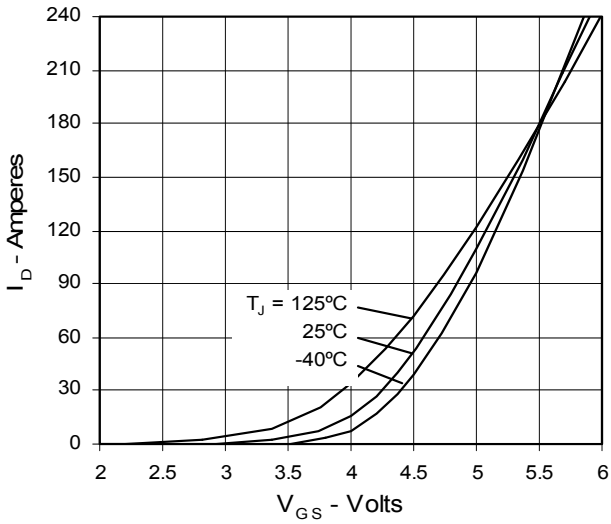

Fig. 8. Transconductance

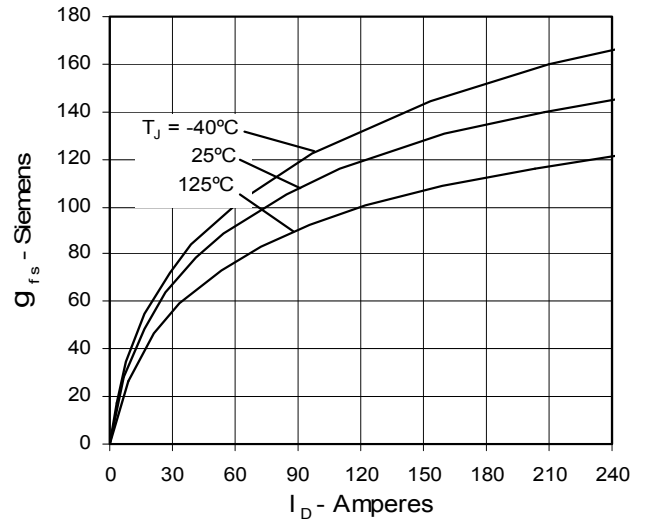

Fig. 9. Source Current vs. Source-To-Drain Voltage

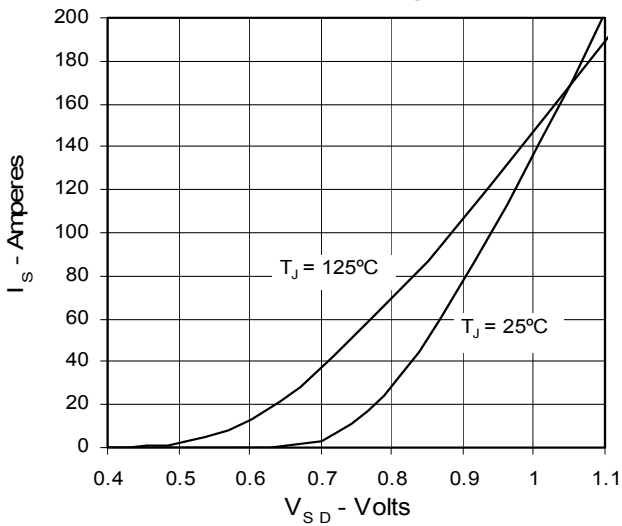

Fig. 10. Gate Charge

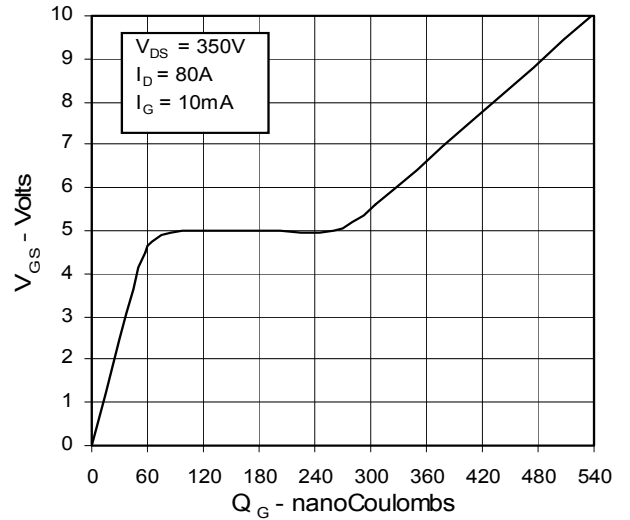

Fig. 11. Capacitance

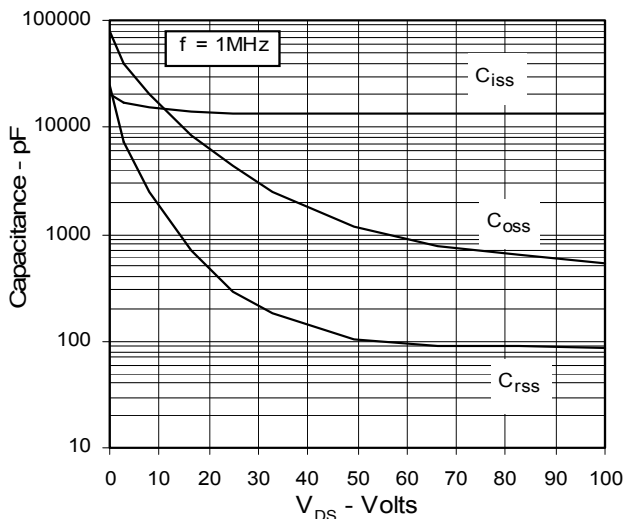
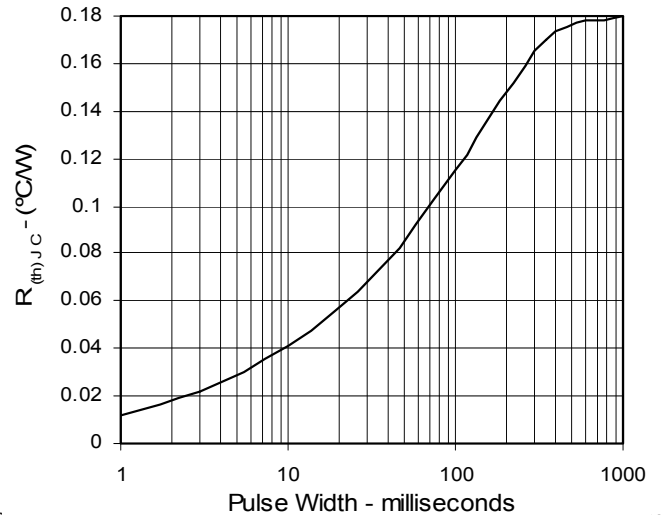

Fig. 12. Maximum Transient Thermal Resistance





Disclaimer Notice - Information furnished is believed to be accurate and reliable. However, users should independently evaluate the suitability of and test each product selected for their own applications. Littelfuse products are not designed for, and may not be used in, all applications. Read complete Disclaimer Notice at www.littelfuse.com/disclaimer-electronics.