

# SMU Series

## SMD, single-turn, sealed cermet trimmers



**This product has been  
DISCONTINUED**

June 2020

- Available in J-hook and gull-wing terminal configurations
- Meets EIA, EIAJ, IPC, VECI standard SMD trimmer designs
- Pb-free and Cd-free construction
- RoHS compliant
- Gold-plated leads provide high conductivity, low contact resistance, high corrosion resistance and good solderability
- Top cross-slot adjustment (top single-slot models available as special order)
- Tape and reel packaging

### SERIES SPECIFICATIONS

Series	Wattage	Manufactured Range ( $\Omega$ )	Rotation	Adj. Location	Taper	Tolerance
SMUA	0.125	50-2M	$250^\circ \pm 10^\circ$	Top	Linear	20%
SMUB	0.25	50-2M	$250^\circ \pm 10^\circ$	Top	Linear	20%

### CHARACTERISTICS

<b>Standard Resistance Range</b>	50 $\Omega$ to 2M $\Omega$ (standard 1, 2 & 5 sequence)	<b>Low Temperature Operation</b>	-55°C, 0.125 watt, 1 hour	$\Delta T/R \leq \pm 2\%$ , S.S. $\leq \pm 2\%$
<b>Resistance Tolerance</b>	$\pm 20\%$ standard	<b>High Temp. Exposure</b>	+125°C, 250 hours	$\Delta T/R \leq \pm 2\%$ , S.S. $\leq \pm 2\%$
<b>End Resistance</b>	1% or 3 $\Omega$ , whichever is greater	<b>Load Life</b>	+70°C, 0.125 watt, 1,000 hours	$\Delta T/R \leq \pm 3\%$ , S.S. $\leq \pm 2\%$
<b>Temp. Range</b>	-55°C to +125°C	<b>Thermal Shock</b>	-55°C, +125°C, 30 minutes each, 5 cycles	$\Delta T/R \leq \pm 2\%$ , S.S. $\leq \pm 1\%$
<b>Resistance Taper</b>	Linear	<b>Shock</b>	100G, 6ms, 6 directions, 3 times each	$\Delta T/R \leq \pm 1\%$ , S.S. $\leq \pm 1\%$
<b>Peak Noise (C.R.V.)</b>	2% or 3 $\Omega$ , whichever is greater	<b>Vibration</b>	10-2,000Hz, 1.5mm amplitude, 20G, 12 hours	$\Delta T/R \leq \pm 1\%$ , S.S. $\leq \pm 1\%$
<b>Power Rating</b>	SMUA 0.125w @70°C; 0w @+125°C SMUB 0.250w @70°C; 0w @+125°C	<b>Humidity</b>	+40°C, 90-95%RH, 0.125 watt, 500 hours	$\Delta T/R \leq \pm 3\%$ , S.S. $\leq \pm 2\%$
<b>Maximum Input Voltage</b>	200VDC or power rating, whichever is smaller	<b>Moisture Resistance</b>	-10°C to +65°C, 80-98%RH, 0.125 watt, 10 cycles, 240 hours	$\Delta T/R \leq \pm 3\%$
<b>Temperature Coefficient</b>	$\pm 100$ ppm/°C, 200 $\Omega$ to 1M $\Omega$ $\pm 250$ ppm/°C, other values	<b>Soldering Heat Resistance</b>	240°C, 10 seconds	$\Delta T/R \leq \pm 1\%$
<b>Insulation Resistance</b>	100M $\Omega$ minimum at 500VDC	<b>Seal Test</b>	+85°C, hot water for 1 minute	
<b>Dielectric Strength</b>	500VAC, 1 minute	<b>Rotational Life</b>	100 cycles without discontinuity, no load	$\Delta T/R \leq \pm 5\%$
<b>Adjustment Travel</b>	$250^\circ \pm 10^\circ$			
<b>Mechanical Travel</b>	$250^\circ \pm 10^\circ$			
<b>Shaft Torque</b>	0 gf•cm (0.69 oz•in) max.			
<b>Stop Strength</b>	200 gf•cm (2.77 oz•in) min.			
<b>Flammability of Plastic Materials</b>	Meets UL 94V-0			
<b>Nominal Weight</b>	0.068g			

**Marking** Resistance value or code, date code

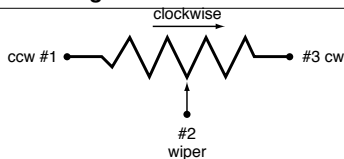

Position of Rotor Inside

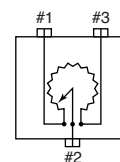

Outside Markings

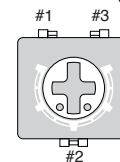

# SMU Series

## SMD, single-turn, sealed cermet trimmers

### CHARACTERISTICS

(continued)

**Flow Soldering Profile**

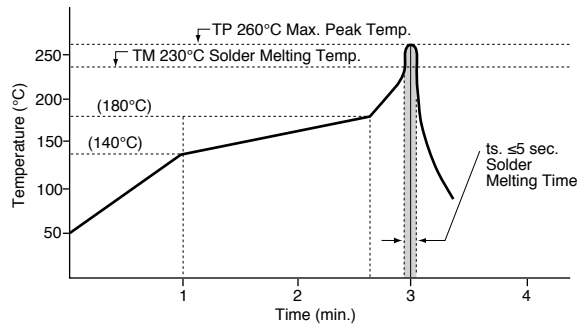

**Reflow Soldering Profile**

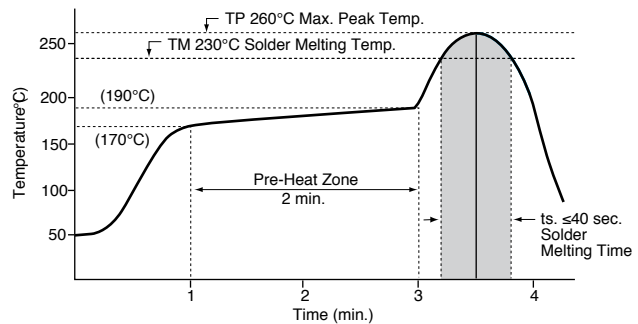

### DIMENSIONS

(mm)

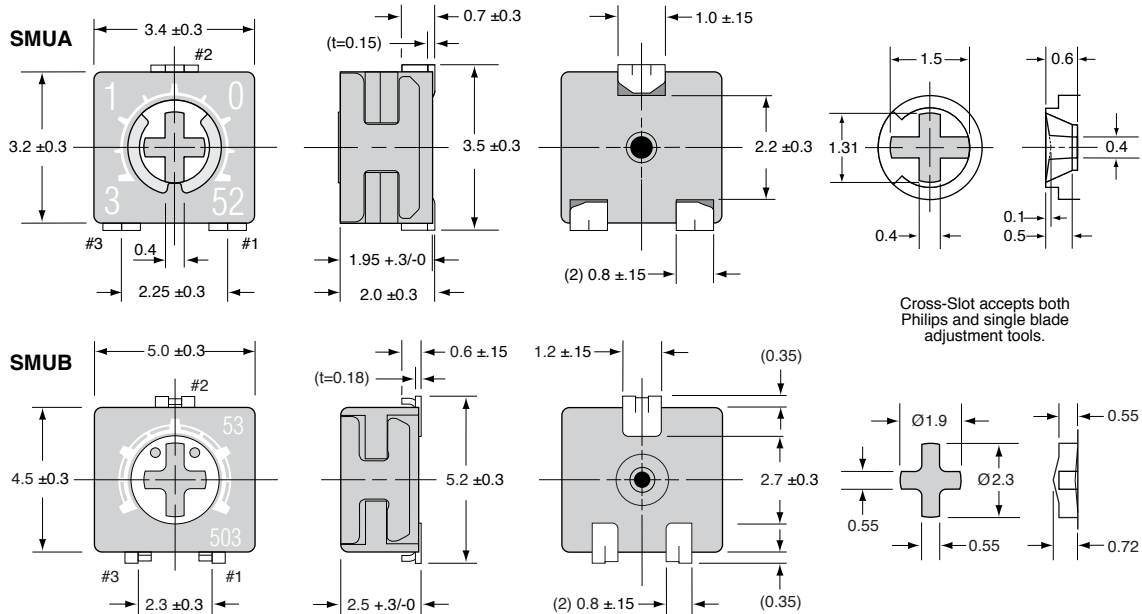

### Land Pattern

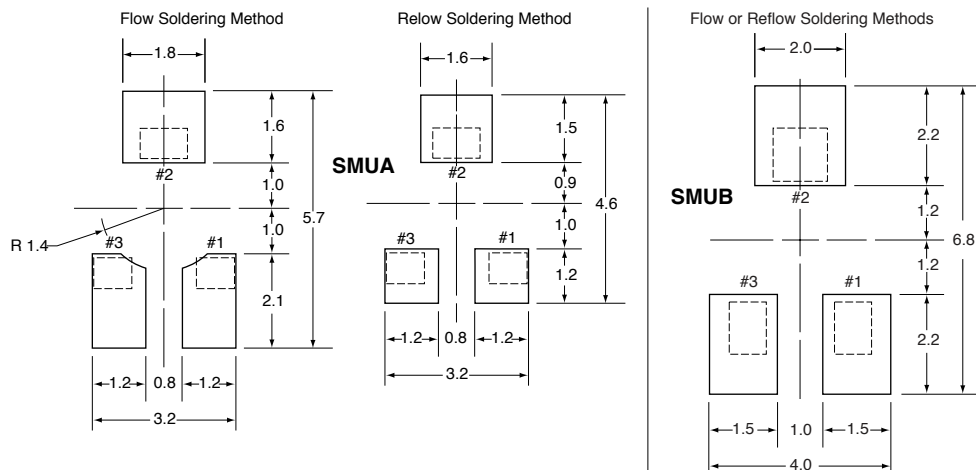

# SMU Series

SMD, single-turn, sealed cermet trimmers

## TAPE AND REEL

(mm)

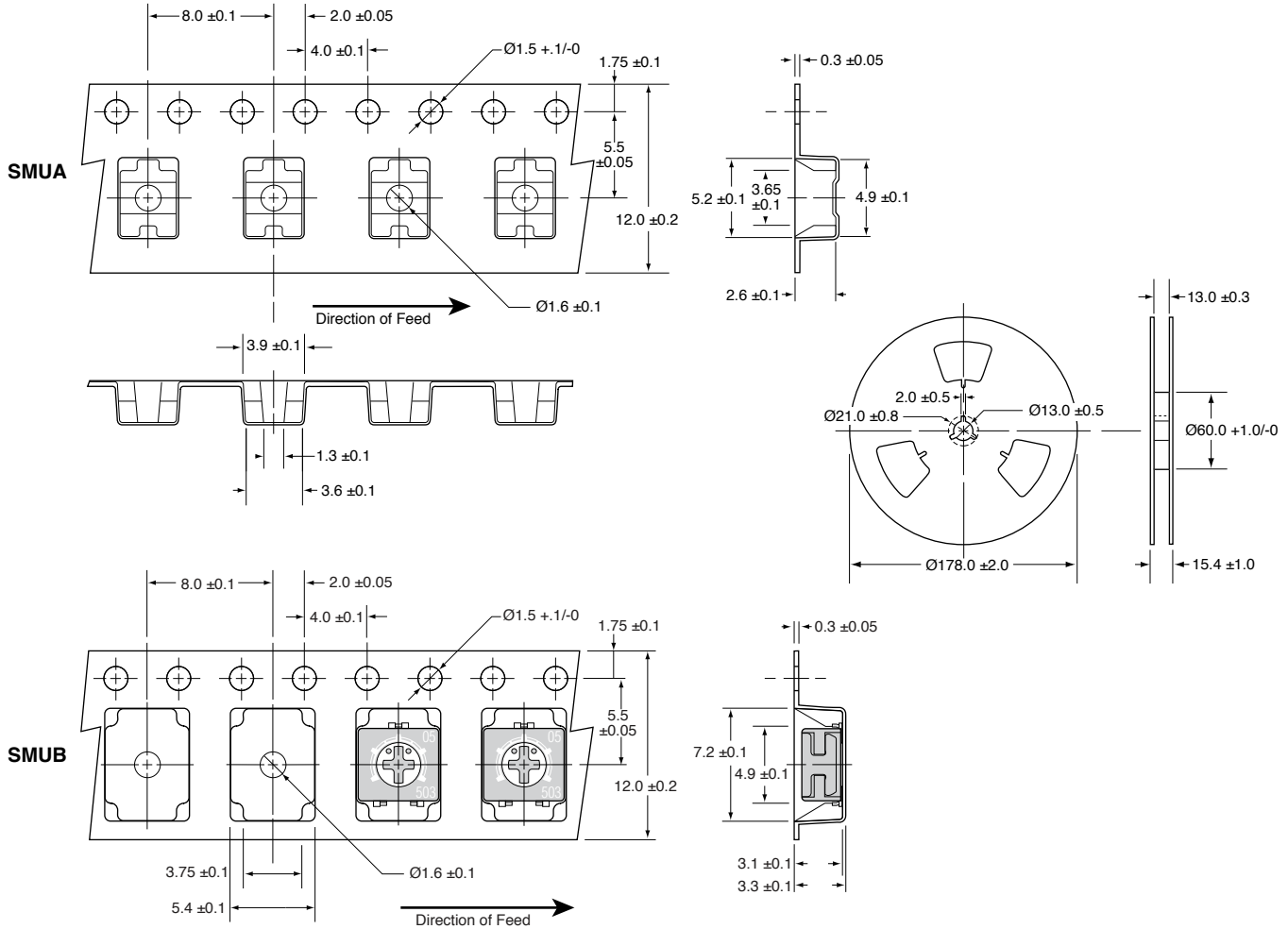

## ORDERING INFORMATION

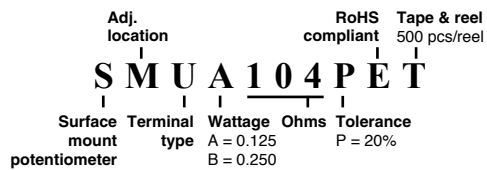

### Standard Part Numbers

SMUA500PET	SMUB500PET
SMUA101PET	SMUB101PET
SMUA201PET	SMUB201PET
SMUA501PET	SMUB501PET
SMUA102PET	SMUB102PET
SMUA202PET	SMUB202PET
SMUA502PET	SMUB502PET
SMUA103PET	SMUB103PET
SMUA203PET	SMUB203PET
SMUA503PET	SMUB503PET
SMUA104PET	SMUB104PET
SMUA204PET	SMUB204PET
SMUA504PET	SMUB504PET
SMUA105PET	SMUB105PET