

# ***TPS54356EVM-058 3-Amp*** ***SWIFT™ Regulator Evaluation Module***

## *User's Guide*

## IMPORTANT NOTICE

Texas Instruments Incorporated and its subsidiaries (TI) reserve the right to make corrections, modifications, enhancements, improvements, and other changes to its products and services at any time and to discontinue any product or service without notice. Customers should obtain the latest relevant information before placing orders and should verify that such information is current and complete. All products are sold subject to TI's terms and conditions of sale supplied at the time of order acknowledgment.

TI warrants performance of its hardware products to the specifications applicable at the time of sale in accordance with TI's standard warranty. Testing and other quality control techniques are used to the extent TI deems necessary to support this warranty. Except where mandated by government requirements, testing of all parameters of each product is not necessarily performed.

TI assumes no liability for applications assistance or customer product design. Customers are responsible for their products and applications using TI components. To minimize the risks associated with customer products and applications, customers should provide adequate design and operating safeguards.

TI does not warrant or represent that any license, either express or implied, is granted under any TI patent right, copyright, mask work right, or other TI intellectual property right relating to any combination, machine, or process in which TI products or services are used. Information published by TI regarding third-party products or services does not constitute a license from TI to use such products or services or a warranty or endorsement thereof. Use of such information may require a license from a third party under the patents or other intellectual property of the third party, or a license from TI under the patents or other intellectual property of TI.

Reproduction of information in TI data books or data sheets is permissible only if reproduction is without alteration and is accompanied by all associated warranties, conditions, limitations, and notices. Reproduction of this information with alteration is an unfair and deceptive business practice. TI is not responsible or liable for such altered documentation.

Resale of TI products or services with statements different from or beyond the parameters stated by TI for that product or service voids all express and any implied warranties for the associated TI product or service and is an unfair and deceptive business practice. TI is not responsible or liable for any such statements.

Following are URLs where you can obtain information on other Texas Instruments products and application solutions:

<b>Products</b>		<b>Applications</b>	
Amplifiers	<a href="http://amplifier.ti.com">amplifier.ti.com</a>	Audio	<a href="http://www.ti.com/audio">www.ti.com/audio</a>
Data Converters	<a href="http://dataconverter.ti.com">dataconverter.ti.com</a>	Automotive	<a href="http://www.ti.com/automotive">www.ti.com/automotive</a>
DSP	<a href="http://dsp.ti.com">dsp.ti.com</a>	Broadband	<a href="http://www.ti.com/broadband">www.ti.com/broadband</a>
Interface	<a href="http://interface.ti.com">interface.ti.com</a>	Digital Control	<a href="http://www.ti.com/digitalcontrol">www.ti.com/digitalcontrol</a>
Logic	<a href="http://logic.ti.com">logic.ti.com</a>	Military	<a href="http://www.ti.com/military">www.ti.com/military</a>
Power Mgmt	<a href="http://power.ti.com">power.ti.com</a>	Optical Networking	<a href="http://www.ti.com/opticalnetwork">www.ti.com/opticalnetwork</a>
Microcontrollers	<a href="http://microcontroller.ti.com">microcontroller.ti.com</a>	Security	<a href="http://www.ti.com/security">www.ti.com/security</a>
		Telephony	<a href="http://www.ti.com/telephony">www.ti.com/telephony</a>
		Video & Imaging	<a href="http://www.ti.com/video">www.ti.com/video</a>
		Wireless	<a href="http://www.ti.com/wireless">www.ti.com/wireless</a>

Mailing Address: Texas Instruments  
Post Office Box 655303 Dallas, Texas 75265

## EVM IMPORTANT NOTICE

Texas Instruments (TI) provides the enclosed product(s) under the following conditions:

This evaluation kit being sold by TI is intended for use for **ENGINEERING DEVELOPMENT OR EVALUATION PURPOSES ONLY** and is not considered by TI to be fit for commercial use. As such, the goods being provided may not be complete in terms of required design-, marketing-, and/or manufacturing-related protective considerations, including product safety measures typically found in the end product incorporating the goods. As a prototype, this product does not fall within the scope of the European Union directive on electromagnetic compatibility and therefore may not meet the technical requirements of the directive.

Should this evaluation kit not meet the specifications indicated in the EVM User's Guide, the kit may be returned within 30 days from the date of delivery for a full refund. **THE FOREGOING WARRANTY IS THE EXCLUSIVE WARRANTY MADE BY SELLER TO BUYER AND IS IN LIEU OF ALL OTHER WARRANTIES, EXPRESSED, IMPLIED, OR STATUTORY, INCLUDING ANY WARRANTY OF MERCHANTABILITY OR FITNESS FOR ANY PARTICULAR PURPOSE.**

The user assumes all responsibility and liability for proper and safe handling of the goods. Further, the user indemnifies TI from all claims arising from the handling or use of the goods. Please be aware that the products received may not be regulatory compliant or agency certified (FCC, UL, CE, etc.). Due to the open construction of the product, it is the user's responsibility to take any and all appropriate precautions with regard to electrostatic discharge.

**EXCEPT TO THE EXTENT OF THE INDEMNITY SET FORTH ABOVE, NEITHER PARTY SHALL BE LIABLE TO THE OTHER FOR ANY INDIRECT, SPECIAL, INCIDENTAL, OR CONSEQUENTIAL DAMAGES.**

TI currently deals with a variety of customers for products, and therefore our arrangement with the user **is not exclusive**.

TI assumes **no liability for applications assistance, customer product design, software performance, or infringement of patents or services described herein**.

Please read the EVM User's Guide and, specifically, the EVM Warnings and Restrictions notice in the EVM User's Guide prior to handling the product. This notice contains important safety information about temperatures and voltages. For further safety concerns, please contact the TI application engineer.

Persons handling the product must have electronics training and observe good laboratory practice standards.

No license is granted under any patent right or other intellectual property right of TI covering or relating to any machine, process, or combination in which such TI products or services might be or are used.

Mailing Address:

Texas Instruments  
Post Office Box 655303  
Dallas, Texas 75265

## **EVM WARNINGS AND RESTRICTIONS**

It is important to operate this EVM within the input and output voltage ranges specified in the EVM User's Guide.

Exceeding the specified input range may cause unexpected operation and/or irreversible damage to the EVM. If there are questions concerning the input range, please contact a TI field representative prior to connecting the input power.

Applying loads outside of the specified output range may result in unintended operation and/or possible permanent damage to the EVM. Please consult the EVM User's Guide prior to connecting any load to the EVM output. If there is uncertainty as to the load specification, please contact a TI field representative.

During normal operation, some circuit components may have case temperatures greater than 55°C. The EVM is designed to operate properly with certain components above 60°C as long as the input and output ranges are maintained. These components include but are not limited to linear regulators, switching transistors, pass transistors, and current sense resistors. These types of devices can be identified using the EVM schematic located in the EVM User's Guide. When placing measurement probes near these devices during operation, please be aware that these devices may be very warm to the touch.

### Mailing Address:

Texas Instruments  
Post Office Box 655303  
Dallas, Texas 75265

# Read This First

---

---

---

---

### ***About This Manual***

This user's guide describes the characteristics, operation, and the use of the TPS54356EVM–058 evaluation module. It covers all pertinent areas involved to properly use this EVM board along with the devices that it supports. The physical PCB layout, schematic diagram, and bill of materials are included.

### ***How to Use This Manual***

This document contains the following chapters:

- Chapter 1—Introduction
- Chapter 2—Test Setup and Results
- Chapter 3—Board Layout
- Chapter 4—Schematic and Bill of Materials

### ***FCC Warning***

This equipment is intended for use in a laboratory test environment only. It generates, uses, and can radiate radio frequency energy and has not been tested for compliance with the limits of computing devices pursuant to subpart J of part 15 of FCC rules, which are designed to provide reasonable protection against radio frequency interference. Operation of this equipment in other environments may cause interference with radio communications, in which case the user at his own expense will be required to take whatever measures may be required to correct this interference.

### ***Trademarks***

SWIFT and PowerPAD are trademarks of Texas Instruments.

# Contents

---

---

---

<b>1</b>	<b>Introduction</b>	<b>1-1</b>
1.1	Background	1-2
1.2	Performance Specification Summary	1-3
1.3	Modifications	1-4
1.3.1	Output Voltage Setpoint	1-4
1.3.2	Switching Frequency	1-4
1.3.3	Input Filter	1-4
1.3.4	UVLO Programming	1-4
1.3.5	Synchronization	1-5
1.3.6	Extending Slow Start Time	1-5
1.3.7	Operation Without the Low-Side FET	1-6
<b>2</b>	<b>Test Setup and Results</b>	<b>2-1</b>
2.1	Input/Output Connections	2-2
2.2	Efficiency	2-3
2.3	Output Voltage Regulation	2-4
2.4	Load Transients	2-5
2.5	Loop Characteristic	2-6
2.6	Output Voltage Ripple	2-7
2.7	Input Voltage Ripple	2-8
2.8	Powering Up and Down	2-9
<b>3</b>	<b>Board Layout</b>	<b>3-1</b>
3.1	Layout	3-2
<b>4</b>	<b>Schematic and Bill of Materials</b>	<b>4-1</b>
4.1	Schematic	4-2
4.2	Bill of Materials	4-3

# Figures

---

---

---

2-1	Measured Efficiency, TPS54356 .....	2-3
2-2	Load Regulation .....	2-4
2-3	Line Regulation .....	2-4
2-4	Load Transient Response, TPS54350 .....	2-5
2-5	Measured Loop Response, TPS54356, $V_I = 6\text{ V}$ .....	2-6
2-6	Measured Loop Response, TPS54356, $V_I = 18\text{ V}$ .....	2-6
2-7	Measured Output Voltage Ripple, TPS54356 .....	2-7
2-8	Input Voltage Ripple, TPS54350 .....	2-8
2-9	Power Up With Tracking .....	2-9
2-10	Powering Down With Tracking .....	2-9
3-1	Top-Side Layout .....	3-2
3-2	Bottom Side Layout (looking from top side) .....	3-3
3-3	Top Side Assembly .....	3-3
3-4	Bottom Side Assembly (looking from top side) .....	3-4
4-1	TPS54356EVM-058 Schematic .....	4-2

# Tables

---

---

---

1-1	Input Voltage and Output Current Summary .....	1-2
1-2	TPS54356EVM-058 Performance Specification Summary .....	1-3
1-3	Output Voltages Available .....	1-4
1-4	Internal UVLO Setting .....	1-5
2-1	EVM Connectors and Testpoints .....	2-2
4-1	TPS54356EVM-058 Bill of Materials .....	4-3

# Introduction

---

---

---

---

This chapter contains background information for the TPS54356 as well as support documentation for the TPS54356EVM-058 evaluation module (HPA058). The TPS54356EVM-058 performance specifications are given, along with a schematic and bill of material for the TPS54356EVM-058.

<b>Topic</b>	<b>Page</b>
1.1 Background .....	1-2
1.2 Performance Specification Summary .....	1-3
1.3 Modifications .....	1-4



## 1.1 Background

The TPS54356 dc/dc converter is designed to provide up to 3-A output from an input voltage source of 4.5 to 20 V. Rated input voltage and output current range is given in Table 1–1. This evaluation module is designed to demonstrate the small PCB areas that may be achieved when designing with the TPS54356 regulator, and does not reflect the high efficiencies that may be achieved when designing with this part. The switching frequency is set at a nominal 500 kHz, allowing the use of a relatively small footprint 22- $\mu$ H output inductor. The high-side MOSFET is incorporated inside the TPS54356 package along with gate drive circuitry for an external synchronous FET. The low drain-to-source on resistance of the MOSFET allows the TPS54356 to achieve high efficiencies and helps to keep the junction temperature low at high output currents. The compensation components are provided internal to the IC. The TPS54356 is a full featured device including programmable under-voltage lockout, bidirectional synchronization, adjustable switching frequency, enable and power good functions

Table 1–1. Input Voltage and Output Current Summary

EVM	INPUT VOLTAGE RANGE	OUTPUT CURRENT RANGE
TPS54356EVM–058	4.5 V to 20 V <sup>†</sup> max 6.0 to 18 V nom	0 to 3 A

<sup>†</sup> Operation specified to 4.0 V, after initial start up.

## 1.2 Performance Specification Summary

A summary of the TPS54356EVM-058 performance specifications is provided in Table 1–2. Specifications are given for an input voltage of 12 V and an output voltage of 3.3 V, unless otherwise specified. The ambient temperature is 25°C for all measurements, unless otherwise noted. The maximum input voltage for the TPS54356 is 4.5 to 20 V. The EVM operates over this range, but is designed and tested for 6-V to 18-V input range (12 V nominal).

Table 1–2. TPS54356EVM-058 Performance Specification Summary

Specification	Test Conditions	Min	Typ	Max	Units
Input voltage range		6.0	12.0	18	V
Output voltage set point			3.3		V
Output current range	$V_I = 6\text{ V to }18\text{ V}$	0		3	A
Line regulation	$I_O = 0\text{--}3\text{ A}, V_I = 6\text{ V to }18\text{ V}$		$\pm 0.1\%$		
Load regulation	$V_I = 6\text{ to }18\text{ V}, I_O = 0\text{ A to }3\text{ A}$		$\pm 0.2\%$		
Load transient response	Voltage change	$I_O = 0.75\text{ A to }2.25\text{ A}$		-80	mV <sub>PK</sub>
	Recovery time			320	μs
	Voltage change	$I_O = 2.25\text{ A to }0.75\text{ A}$		80	mV <sub>PK</sub>
	Recovery time			320	μs
Loop bandwidth	$V_I = 6\text{ V}$		21.5		kHz
Phase margin	$V_I = 6\text{ V}$		80		°
Loop bandwidth	$V_I = 18\text{ V}$		25.0		kHz
Phase margin	$V_I = 18\text{ V}$		71		°
Input ripple voltage			160	200	mV <sub>PP</sub>
Output ripple voltage			5	10	mV <sub>PP</sub>
Output rise time			3.5		ms
Operating frequency			500		kHz
Maximum efficiency	$V_I = 6.0\text{ V}, V_O = 3.3\text{ V}, I_O = 0.5\text{ A}$		92%		

## 1.3 Modifications

While the TPS54356EVM-058 is designed to demonstrate the small size that can be attained when designing with the TPS54356, features which allow for extensive modifications have been included in this EVM.

### 1.3.1 Output Voltage Setpoint

To change the output voltage of the EVM, it is necessary to change the SWIFT device (U1). Table 1-3 list the part numbers for the available output voltages.

Table 1-3. Output Voltages Available

Output Voltage (V)	Part Number
1.2	TPS54352
1.5	TPS54353
1.8	TPS54354
2.5	TPS54355
3.3	TPS54356
5.0	TPS54357

### 1.3.2 Switching Frequency

The switching frequency of the EVM is set to 500 kHz by leaving R4 open. Shorting R4 sets the operating frequency to 250 kHz. The switching frequency may also be trimmed to any value between 250 kHz and 700 kHz by changing the value of R4 using Equation 1-1. Decreasing the switching frequency results in increased output ripple unless the value of L1 is increased.

Equation 1-1.

$$RT(k\Omega) = \frac{46000}{f_s(kHz) - 35.9}$$

If using a programmable switching frequency, be sure to populate R11 with a 10-k $\Omega$  resistor to decrease susceptibility to noise at the SYNC pin.

### 1.3.3 Input Filter

An onboard electrolytic input capacitor is included at C1. Depending on the application this capacitor may be removed.

### 1.3.4 UVLO Programming

The TPS54356 is provided with an internal voltage divider from  $V_{IN}$  to AGND. The start and stop thresholds are given in Table 1-4.

Table 1–4. Internal UVLO Setting

		Start Voltage Threshold	Stop Voltage Threshold
VIN	TPS54352-6	4.49 V	3.69 V
	TPS54357	6.65 V	5.45 V
UVLO		1.24 V	1.02 V

To set a different set of thresholds, R6 and R7 can be selected using the following equations.

Equation 1–2.

$$R6 = \frac{V_{I(\text{start})} \times R7}{UVLO(\text{start})} - R7$$

Equation 1–3.

$$V_{I(\text{stop})} = \frac{(R6 + R7) \times 1.02}{R7}$$

1 k $\Omega$  is a good value for R7.

### 1.3.5 Synchronization

The TPS54356EVM-058 provides the capability for synchronous operation with other devices of the TPS5435X family. When the EVM is configured so that the switching frequency is set to 250 or 500 kHz operation by grounding or floating the RT pin, the SYNC pin functions as an output. If the RT pin is terminated with a resistor to ground, setting a programmable operating frequency, then the SYNC pin functions as an input. When operated as an input, the SYNC pin is falling-edge triggered. When operating as an output, the falling edge of the SYNC signal is approximately 180 degrees out of phase with the rising edge of the PH signal. This allows two TPS5435X devices to share an input capacitor with reduced input ripple due to cancellation. The SYNC signal is accessed on the EVM by the J3 header. R11 should be terminated with a 10-k $\Omega$  resistor if the SYNC signal is configured as an input.

### 1.3.6 Extending Slow Start Time

The slow start time may be extended by populating the R12 and C6 positions on the EVM. R12 must be 2 k $\Omega$  and C6 must be less than 0.47  $\mu$ F. A desired slow start time determines the value for C6, and is given by Equation 1–4.

Equation 1–4.

$$C6 (\mu\text{F}) = 5.5 \times 10^{-3} \times 0.818 \times T_{SS} (\text{ms})$$

Note that this equation is only valid for the TPS54356. If the EVM is modified for a different output voltage, see the product data sheet (SLVS519) for additional information on setting the slow start time.

### **1.3.7 Operation Without the Low-Side FET**

It is possible to operate the TPS54356EVM-058 with a catch diode instead of the external low-side FET. Pads for the catch diode D1 are provided on the back of the PCB. The Motorola MBRS340T3 works well for this application.

# Test Setup and Results

---

---

---

This chapter describes how to properly connect, setup, and use the TPS54356EVM-058 evaluation module. The chapter also includes test results typical for the TPS54356EVM-058 and covers efficiency, output voltage regulation, load transients, loop response, output ripple, input ripple, and startup.

<b>Topic</b>	<b>Page</b>
2.1 Input/Output Connections .....	2-2
2.2 Efficiency .....	2-3
2.3 Output Voltage Regulation .....	2-4
2.4 Load Transients .....	2-5
2.5 Loop Characteristics .....	2-6
2.6 Output Voltage Ripple .....	2-7
2.7 Input Voltage Ripple .....	2-8
2.8 Powering Up and Down .....	2-9

## 2.1 Input/Output Connections

The TPS54356EVM-058 is provided with input/output connectors and testpoints as shown in Table 2–1. A power supply capable of supplying 4 A should be connected to J1 through a pair of 20-AWG wires. The load should be connected to J2 through a pair of 20-AWG wires. The maximum load current capability should be 3 A. Wire lengths should be minimized to reduce losses in the wires. Testpoints TP4 and TP5 provide a place to monitor the input voltage, while TP3 and TP6 are used to monitor the output voltage.

Table 2–1. EVM Connectors and Testpoints

Reference Designator	Function
J1	V <sub>in</sub> , 6 to 18 V nominal, 4.5 to 20 V maximum
J2	V <sub>out</sub> , 3.3 V at 0 to 3 A
J3	2-pin header for SYNC signal input or output
J4	2-pin header for ENA, ground to disable , open to enable
TP1	Connection for external 3.3-V or 5-V PWRGD pullup
TP2	PWRGD signal monitor testpoint
TP3	Output voltage testpoint at V <sub>OUT</sub> connector
TP4	Input voltage testpoint at V <sub>IN</sub> connector
TP5	GND testpoint at V <sub>IN</sub> connector
TP6	GND testpoint at V <sub>OUT</sub> connector
TP7	V <sub>SENSE</sub> testpoint
TP8	PH testpoint
TP9	UVLO testpoint
TP10	RT testpoint

## 2.2 Efficiency

The TPS54356EVM-058 efficiency peaks at load current of about 1 to 2 A, and then decreases as the load current increases towards full load. Figure 2-1 shows the efficiency for the TPS54356 at an ambient temperature of 25°C. The efficiency is lower at higher ambient temperatures, due to temperature variation in the drain-to-source resistance of the MOSFETs. The efficiency is slightly lower at 700 kHz than efficiency at lower switching frequencies due to the gate and switching losses in the MOSFETs.

Figure 2-1. Measured Efficiency, TPS54356

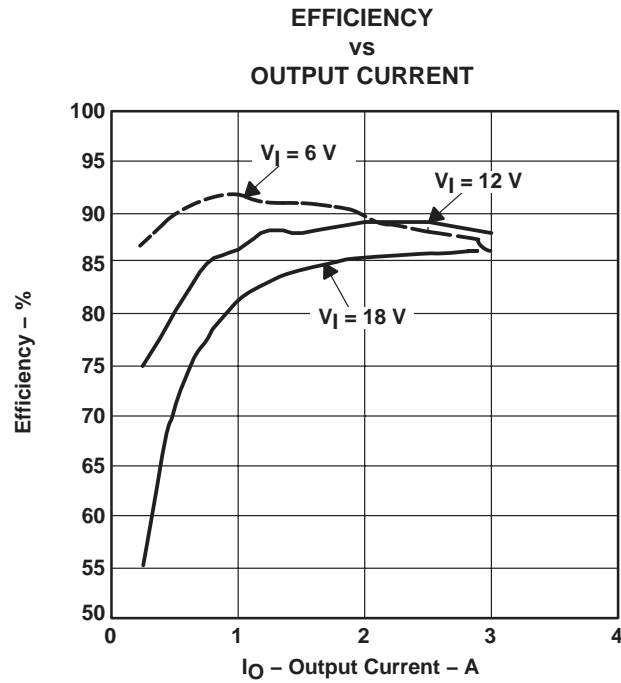



## 2.3 Output Voltage Regulation

The output voltage load regulation of the TPS54356EVM-058 is shown in Figure 2-2, while the output voltage line regulation is shown in Figure 2-3. Measurements are given for an ambient temperature of 25°C.

Figure 2-2. Load Regulation

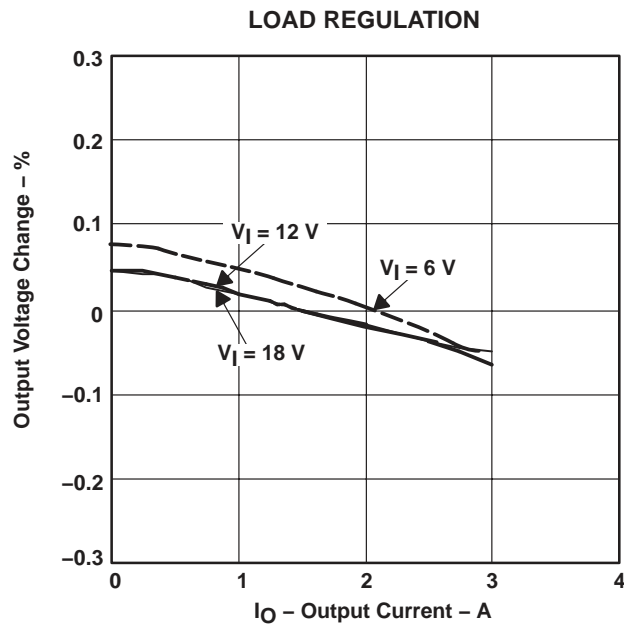
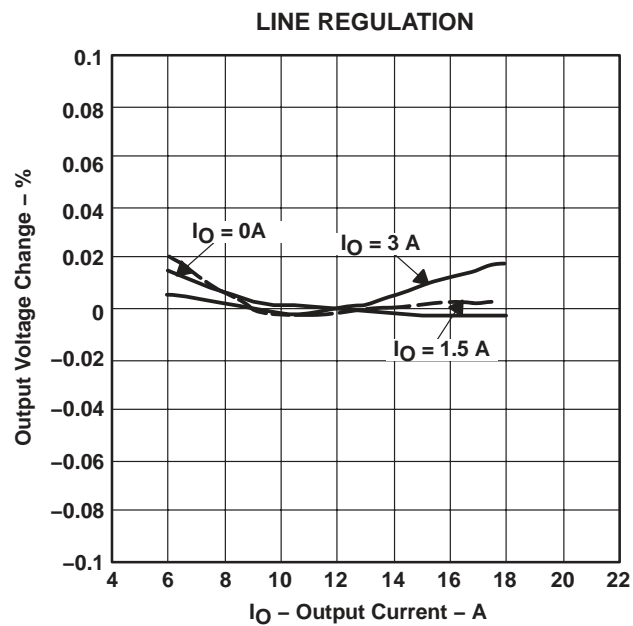

Figure 2-3. Line Regulation



## 2.4 Load Transients

The TPS54356EVM-058 response to load transients is shown in Figure 2-4. The current step is from 25 to 75 percent of maximum rated load. Total peak-to-peak voltage variation is as shown, including ripple and noise on the output.

Figure 2-4. Load Transient Response, TPS54350

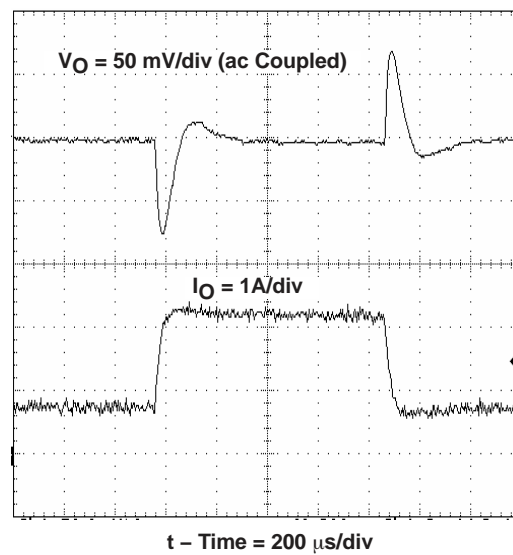

## 2.5 Loop Characteristic

The TPS54356EVM-058 loop response characteristics are shown in Figure 2–5 and Figure 2–6. Gain and phase plots are shown for each device at minimum and maximum operating voltage.

Figure 2–5. Measured Loop Response, TPS54356,  $V_I = 6\text{ V}$

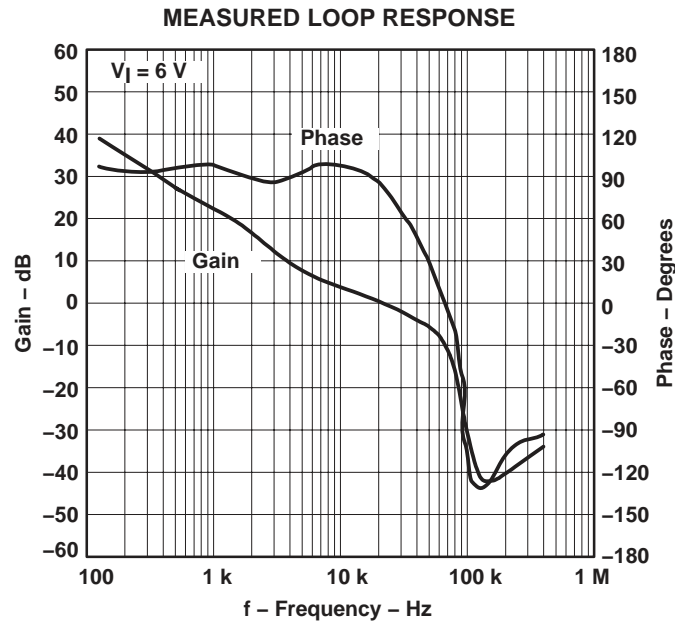
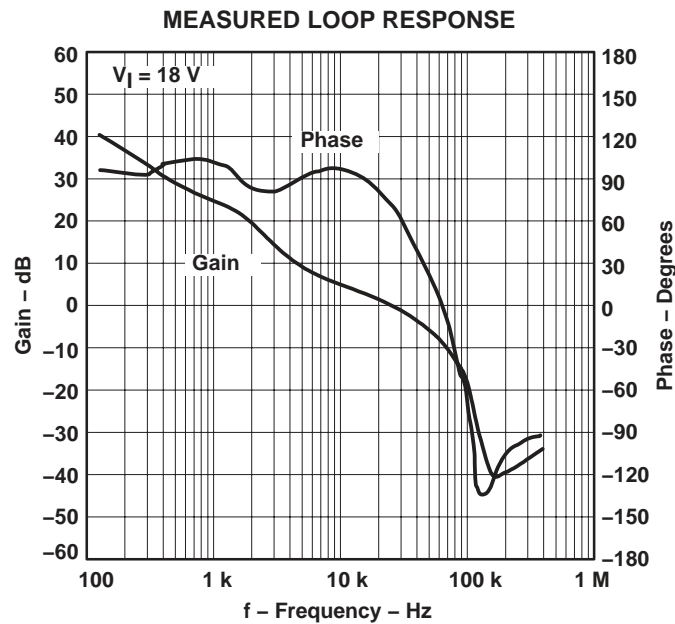

Figure 2–6. Measured Loop Response, TPS54356,  $V_I = 18\text{ V}$



## 2.6 Output Voltage Ripple

The TPS54356EVM-058 output voltage ripple is shown in Figure 2-7. The input voltage is 12 V for the TPS54356. Output current is the rated full load of 3 A. Voltage is measured directly across output capacitors.

Figure 2-7. Measured Output Voltage Ripple, TPS54356

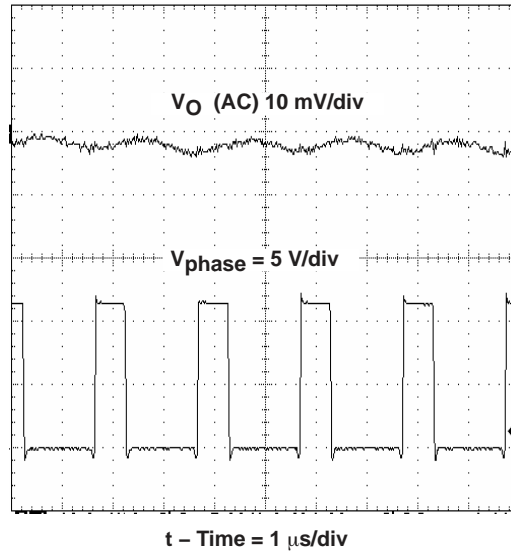

## 2.7 Input Voltage Ripple

The TPS5456EVM-058 output voltage ripple is shown in Figure 2–8. The input voltage is 12 V for the TPS54356. Output current for each device is rated full load of 3 A.

Figure 2–8. Input Voltage Ripple, TPS54350

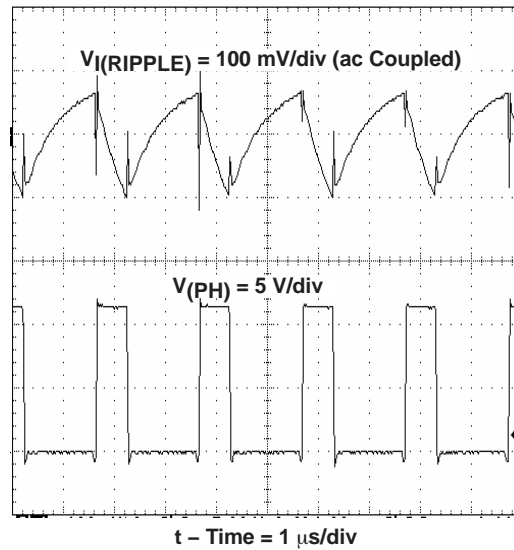

## 2.8 Powering Up and Down

The TPS54356EVM-058 start up waveforms are shown in Figure 2-9. In the figure, the top trace shows  $V_i$  charging up from 0-V to 12-V. When the input voltage reaches the internally set UVLO threshold voltage of 4.49 V,  $V_O$  begins to ramp up linearly at the internally-set slow start rate towards 3.3 V. As soon as the output reaches 97 percent of its preset final value, the PWRGD signal is asserted high. In this case, the PWRGD output has been pulled up to 3.3V.

The power-down sequence is shown in Figure 2-10. When the input decays to the stop voltage threshold of 3.69 V, the regulator turns off and the output starts to decay toward 0 V. The shape of the discharge curve is dependent on the load. As soon as the output falls out of regulation, the PWRGD signal is asserted low. When the input voltage decays below about 2.8 V, the internal control circuitry state is undefined and the PWRGD signal *floats*.

Figure 2–9. Power Up With Tracking

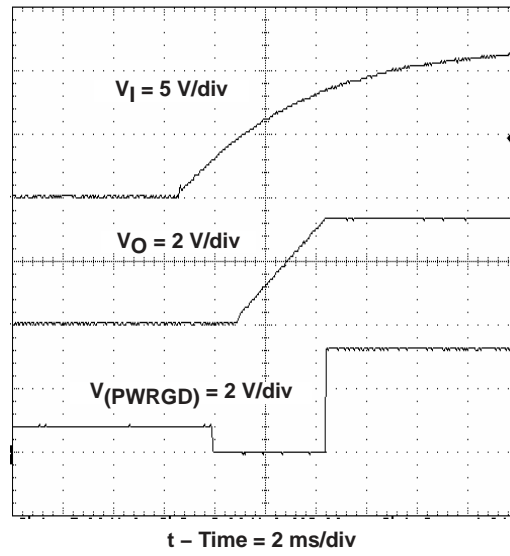
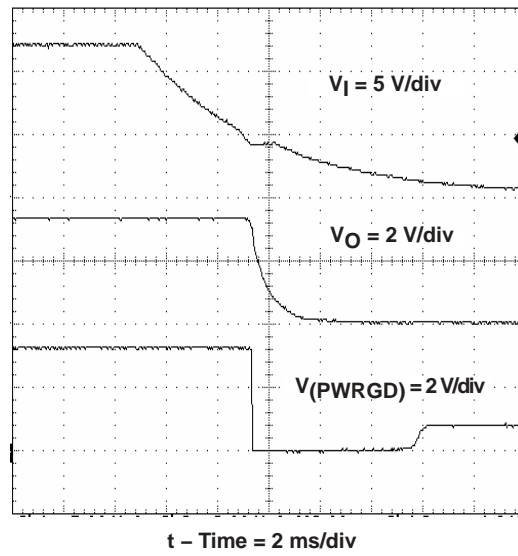

Figure 2–10. Powering Down With Tracking



# Board Layout

---

---

---

---

This chapter provides a description of the TPS54356EVM-058 board layout and layer illustrations.

<b>Topic</b>	<b>Page</b>
3.1 Layout .....	3-2



### 3.1 Layout

The board layout for the TPS54356EVM-058 is shown in Figure 3-1 through Figure 3-4. The topside layer of the TPS54356EVM-058 is laid out in a manner typical of a user application. The top and bottom layers are 1.5 oz. copper.

The top layer contains the main power traces for  $V_{IN}$ ,  $V_{OUT}$ , and  $V_{PHASE}$ . Also on the top layer are connections for the remaining pins of the TPS54356, and a large ground area. The bottom layer contains ground and  $V_{OUT}$  copper areas, and some signal routing. The top and bottom ground traces are connected with multiple vias placed around the board including 10 directly under the TPS54356 device to provide a thermal path from the PowerPAD™ land to ground.

The input decoupling capacitors (C5 and C9), bias decoupling capacitor (C4), and bootstrap capacitor (C3) are all located as close to the IC as possible. In addition, the compensation components are also kept close to the IC. The compensation circuit ties to the output voltage at the point of regulation, adjacent to the high frequency bypass output capacitor.

Figure 3-1. Top-Side Layout

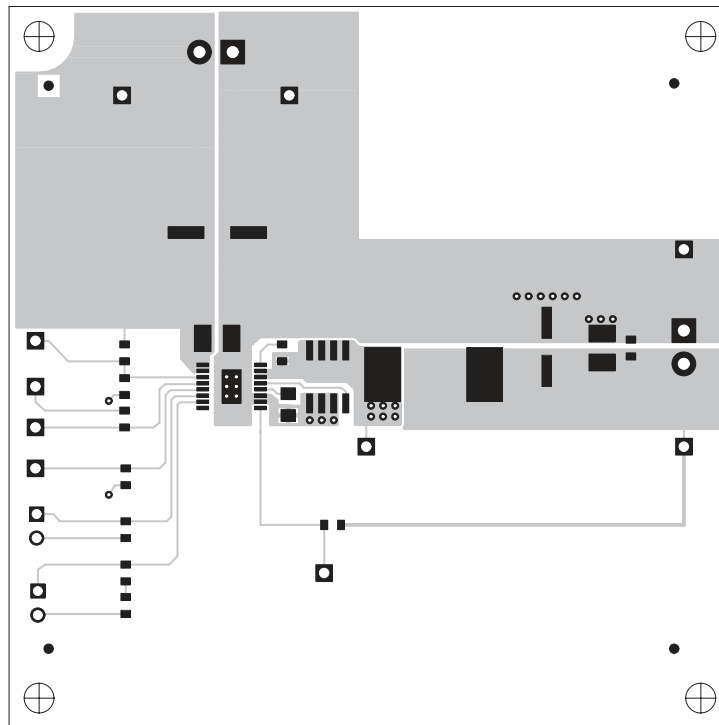

Figure 3–2. Bottom Side Layout (looking from top side)

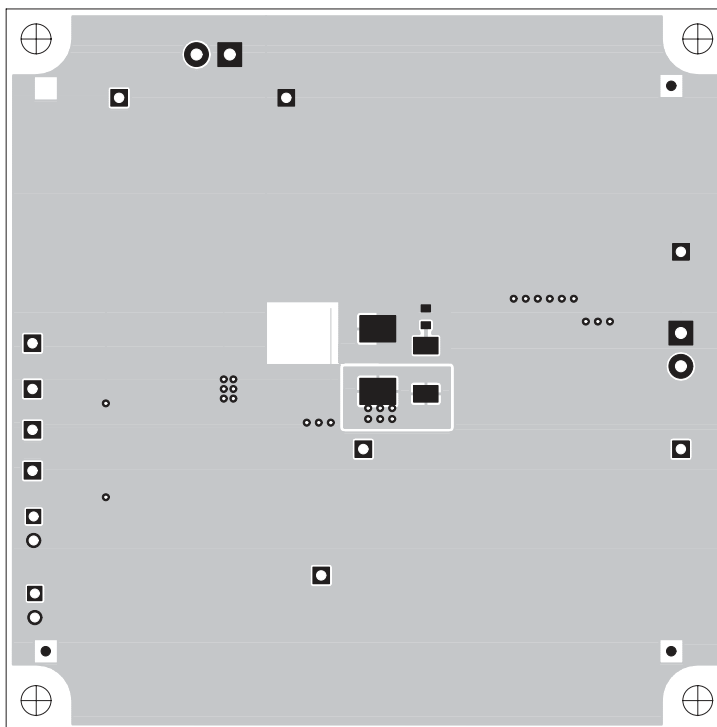

Figure 3–3. Top Side Assembly

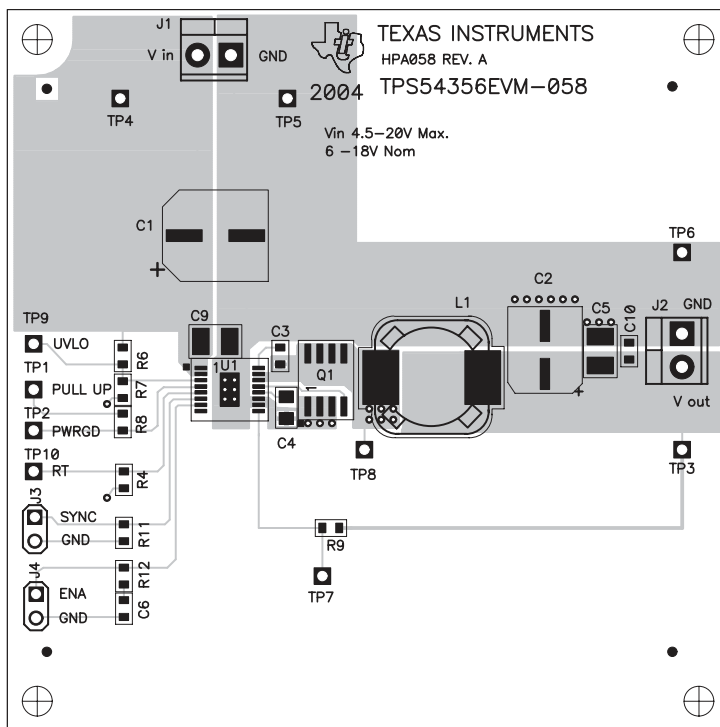
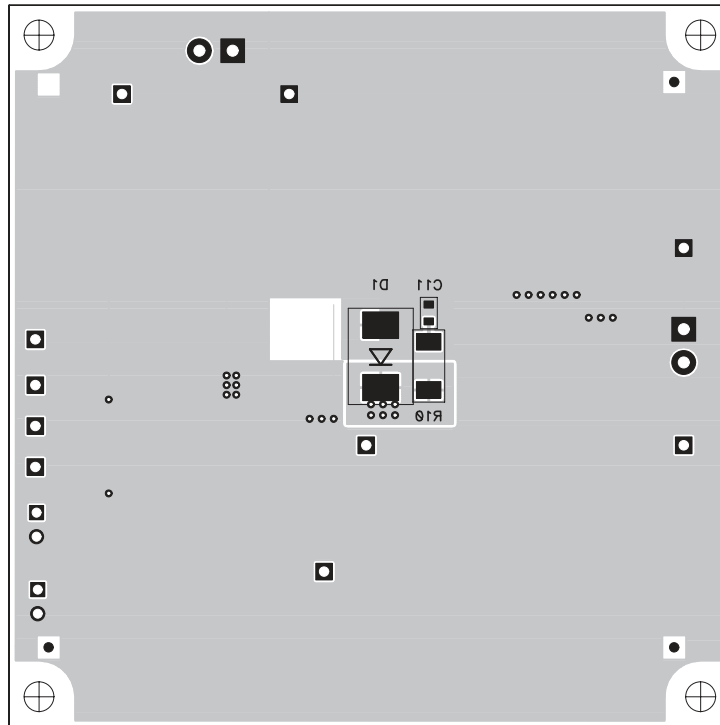

Figure 3–4. Bottom Side Assembly (looking from top side)



# Schematic and Bill of Materials

---

---

---

The TPS54356EVM–058 schematic and bill of materials are presented in this chapter.

<b>Topic</b>	<b>Page</b>
4.1 Schematic .....	4-2
4.2 Bill of Materials .....	4-3

## 4.1 Schematic

The schematic for the TPS54356EVM-058 is shown in Figure 4-1.

Figure 4-1. TPS54356EVM-058 Schematic

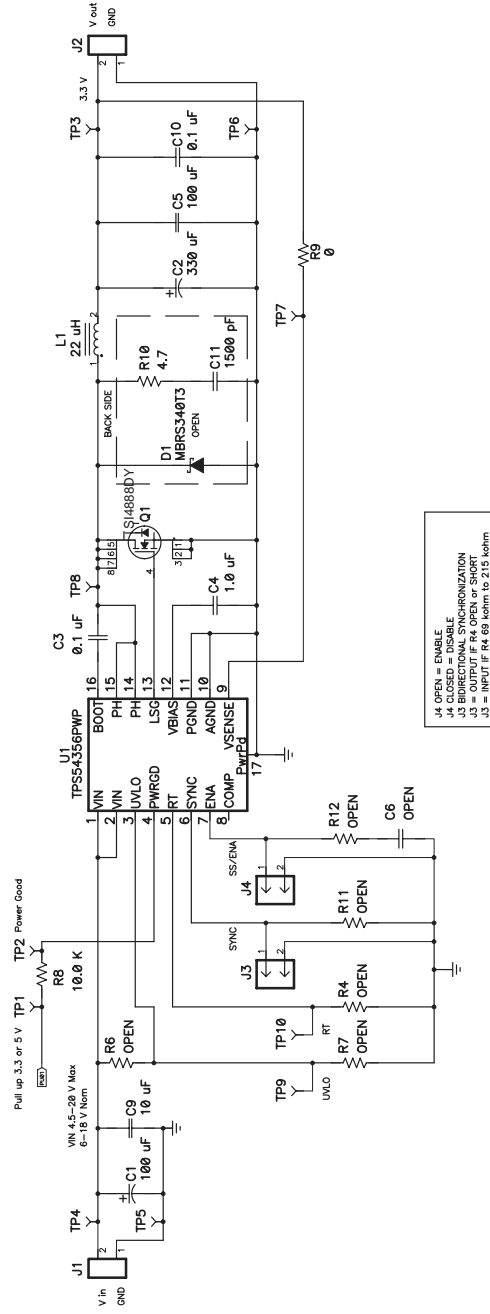

## 4.2 Bill of Materials

The bill of materials for the TPS54356EVM-058 is given by Table 4-1.

Table 4-1. TPS54356EVM-058 Bill of Materials

COUNT	RefDes	DESCRIPTION	SIZE	MFR	PART NUMBER
1	C1	Capacitor, aluminum, SM, 100 $\mu$ F, 35-V, 160-m $\Omega$ (FK series)	8x10mm	Panasonic	EEV-FK1V101P
1	C11	Capacitor, ceramic, 1500-pF, 50-V, X7R, 10%	603	std	std
1	C2	Capacitor, aluminum, 330 $\mu$ F, 6.3-V, 20%, FK Series	0.268 $\times$ 0.307	Panasonic	EEVFK0J331XP
2	C3, C10	Capacitor, Ceramic, 0.1 $\mu$ F, 16-V, X7R, 10%	603	std	std
1	C4	Capacitor, Ceramic, 1.0 $\mu$ F, 16-V, X7R 10%	805	std	std
1	C5	Capacitor, Ceramic, 100 $\mu$ F, 6.3-V, X5R, 20%	1210	TDK	C3225X5R0J107M
—	C6	Capacitor, Ceramic, xxx $\mu$ F, 50-V, X7R, 10%	603	std	std
1	C9	Capacitor, Ceramic, 10 $\mu$ F, 25-V, X5R, 20%	1210	Taiyo Yuden	TMK325BJ106MN
—	D1	Diode, Schottky, 3-A, 40-V	SMC	Motorola	MBRS340T3
2	J1, J2	Terminal Block, 2-pin, 6-A, 3.5mm	75525	OST	ED1514
2	J3, J4	Header, 2-pin, 100 mil spacing, (36-pin strip)	0.100 $\times$ 2	Sullins	PTC36SAAN
1	L1	Inductor, SMT, 22 $\mu$ H, 7.57-A, 39-m $\Omega$	250000	Coiltronics	DR127-220
1	Q1	MOSFET, N-ch, 30-V, 16-A, 7-m $\Omega$	SO8	Siliconix	Si4888DY
1	R10	Resistor, Chip, 4.7 $\Omega$ , 1/2 W, 5%	2010	std	std
—	R4, R6, R7, R11, R12	Resistor, Chip, xxx $\Omega$ , 1/16-W, 1%	603	std	std
1	R8	Resistor, Chip, 10.0 K $\Omega$ , 1/16-W, 1%	603	std	std
1	R9	Resistor, Chip, 0 $\Omega$ , 1/16-W, 1%	603	std	std
1	—	Shunt, 100-mil, Black	0.100	3M	929950-00
6	TP1, TP3, TP4, TP8, TP9, TP10	Test Point, Red, 1 mm	0.038	Farnell	240-345
4	TP2, TP5, TP6, TP7	Test Point, Black, 1 mm	0.038	Farnell	240-333
1	U1	IC, dc/dc converter	PWP16	TI	TPS54356PWP
1	—	PCB, 3 In $\times$ 3 In $\times$ 0.062 In		Any	HPA058

