

REVISIONS				
REV.	ECO. NO	DESCRIPTION	DATE	BY
A	2493	INITIAL RELEASE	11/14/2011	JH

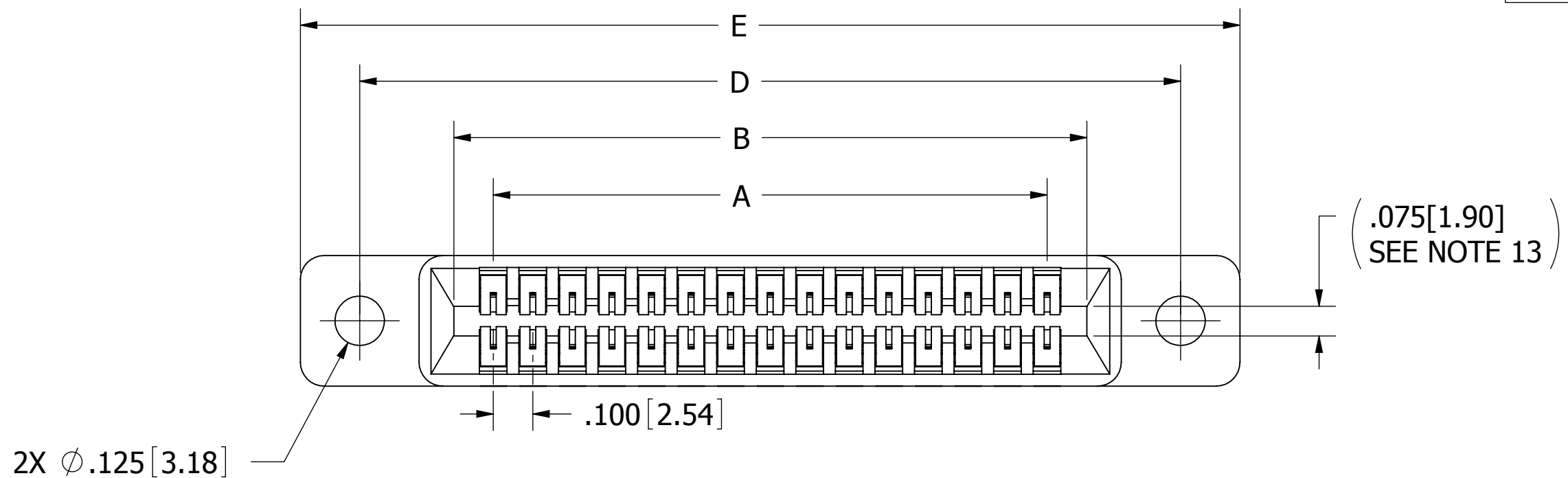

2X ϕ .125 [3.18]

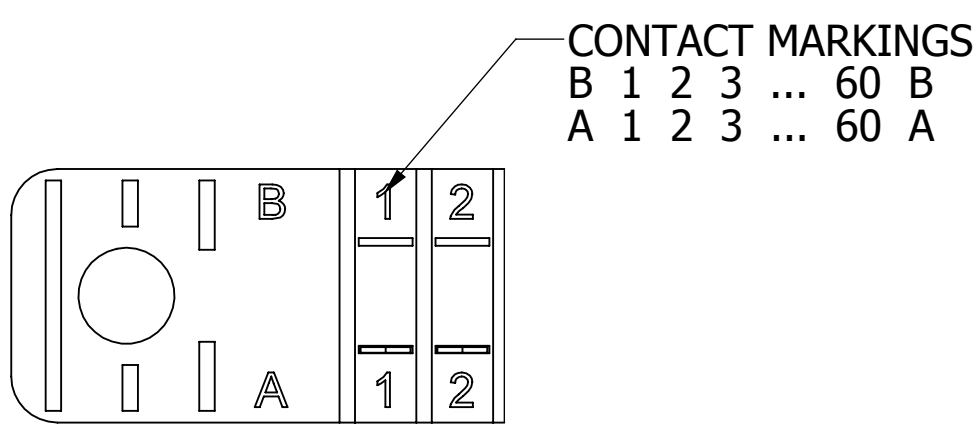
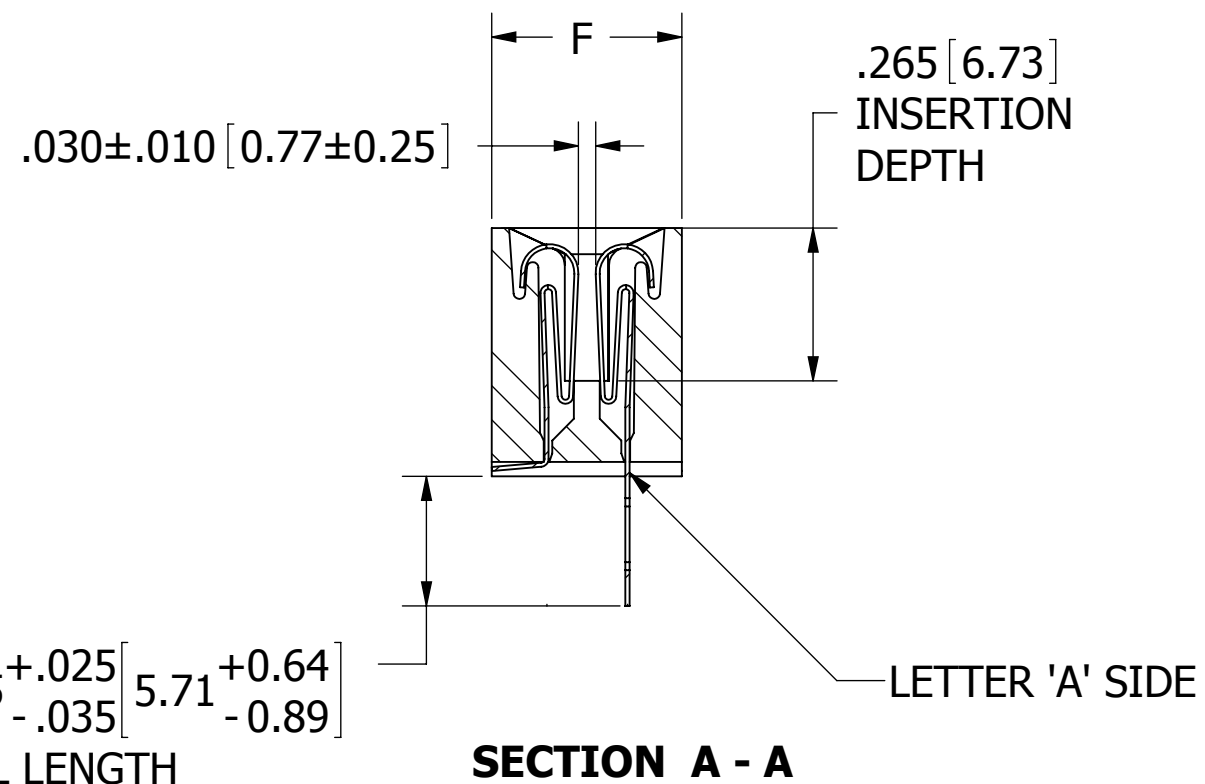
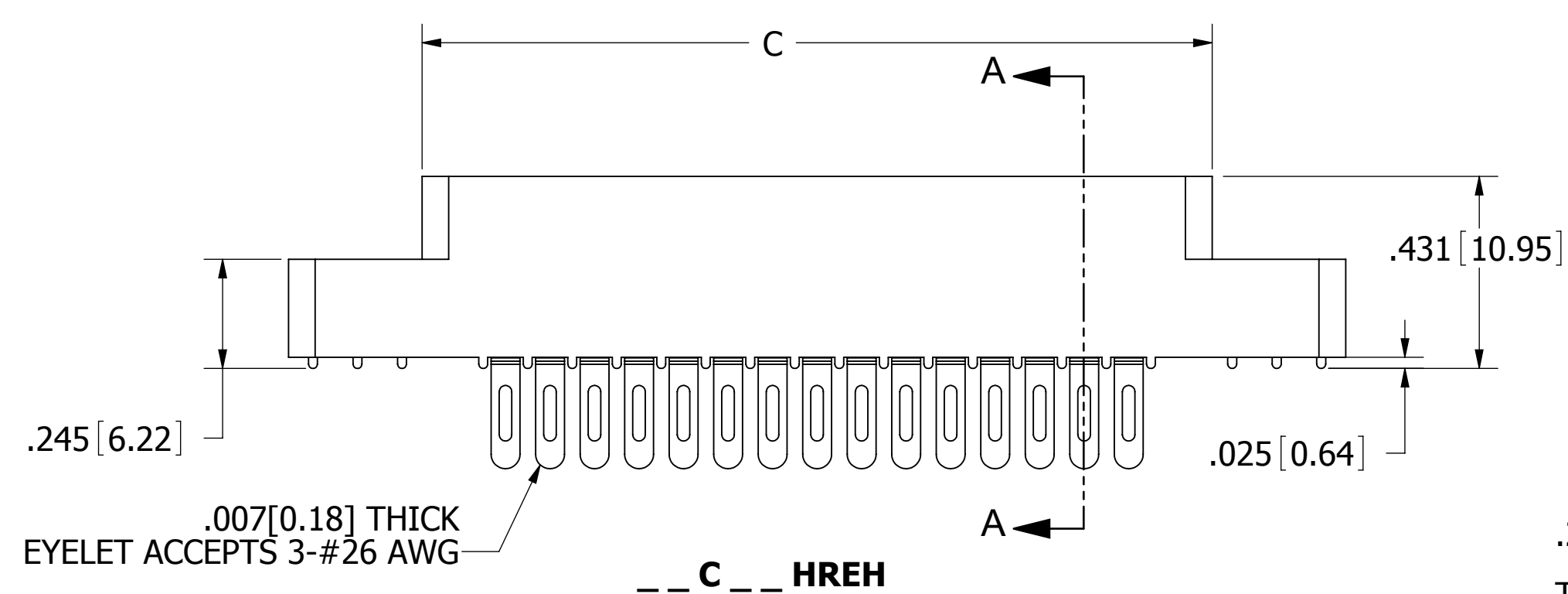

**CONTACT ID
SCALE 2:1
(CONTACT PINS
OMITTED FOR CLARITY)**

- NOTES:**
- INSULATOR MATERIAL: SEE PART NUMBER CODING
 - CONTACT MATERIAL: SEE PART NUMBER CODING
 - PLATING: SEE PART NUMBER CODING
 - OPERATING TEMPERATURE: SEE PART NUMBER CODING
 - PROCESSING TEMP: SEE PART NUMBER CODING
 - UL FLAMMABILITY RATING: 94V-0
 - DIELECTRIC WITHSTANDING VOLTAGE: 750 VAC MINIMUM AT SEA LEVEL
 - CURRENT RATING: 3 AMPS PER CONTACT
 - CONTACT RESISTANCE: 30 MILLI OHMS MAX
 - INSULATION RESISTANCE: 5000 MEGA OHMS
 - DURABILITY: 500 CYCLES MIN
 - CONNECTOR IDENTIFICATION: THE PART SHALL BE MARKED WITH A PART NUMBER AND LOT CODE
 - BOARD THICKNESS ACCOMMODATED: $.062 \pm .008$ [1.57 ± 0.20]
 - INSERTION FORCE: 16 OZ MAX PER CONTACT PAIR WHEN USING A $.062$ [1.57] TEST BLADE
INTERNAL INSPECTION TO BE PER SULLIN'S WORK INSTRUCTION WI7.3-01
 - WITHDRAWAL FORCE: 1 OZ MIN PER CONTACT PAIR USING $.062$ [1.57] PCB



CUSTOMER COPY

UNLESS OTHERWISE SPECIFIED: DIMENSIONS ARE IN INCHES [MM]		DRAWN	DATE	NAME		
			11/14/2011	JH		
TOLERANCES:					<small>THE INFORMATION HEREIN CONTAINS PROPRIETARY INFORMATION OF SULLINS ELECTRONICS AND IS NOT TO BE REPRODUCED, USED OR DISCLOSED TO OTHERS FOR ANY PURPOSE EXCEPT AS SPECIFICALLY AUTHORIZED IN WRITING BY AN OFFICER OF SULLINS ELECTRONICS.</small>	
ANGULAR: ± 1°						
DECIMALS .XX = ± .02 [.5] .XXX = ± .005 [.13] .XXXX = ± .0005 [.013]						
		TITLE			EDGE CARD, .100 CC LP	
		PART NUMBER			--- C --- HRE ---	
SIZE	CAGE CODE	DWG. NO.	REV			
C	54453	C11917	A			
SCALE: 3:1		SHEET 1 OF 3				

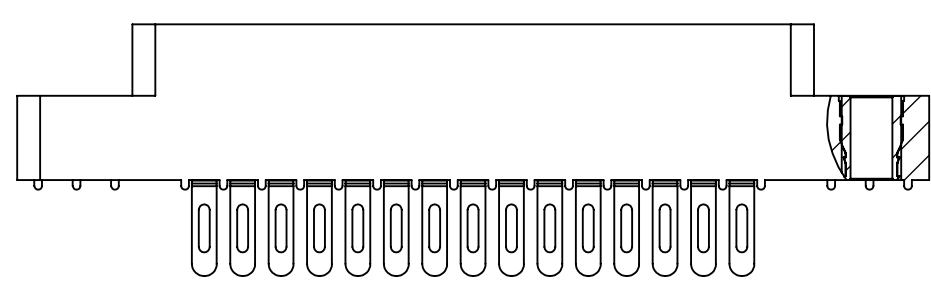
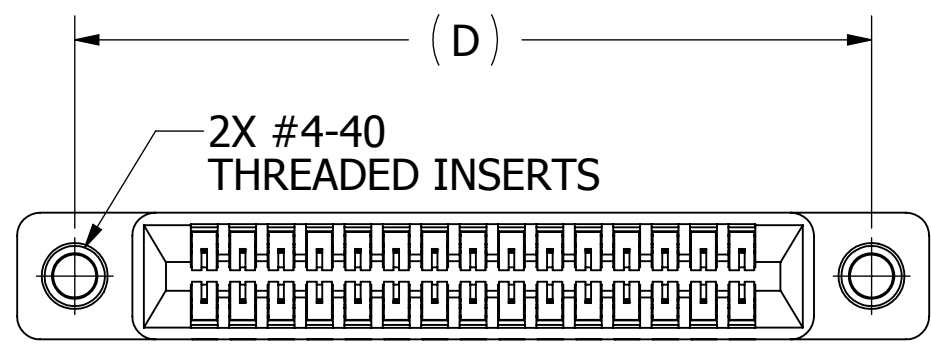

__ C __ HREI

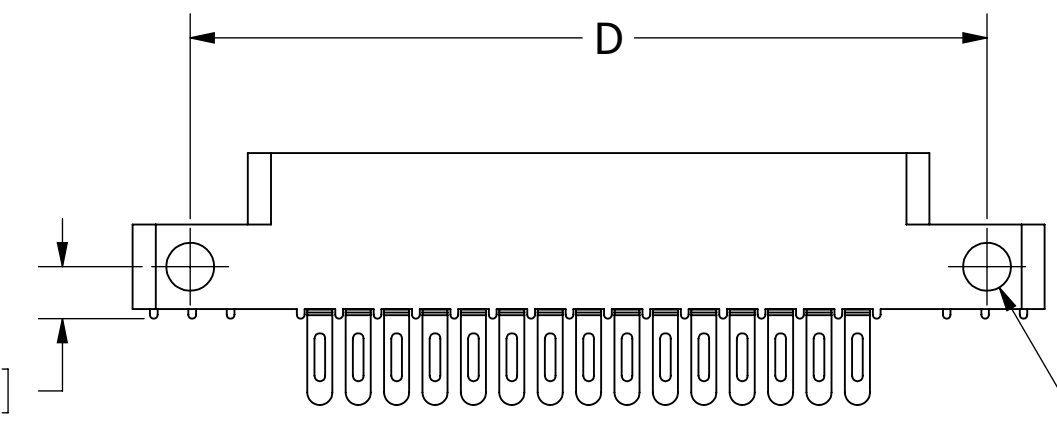
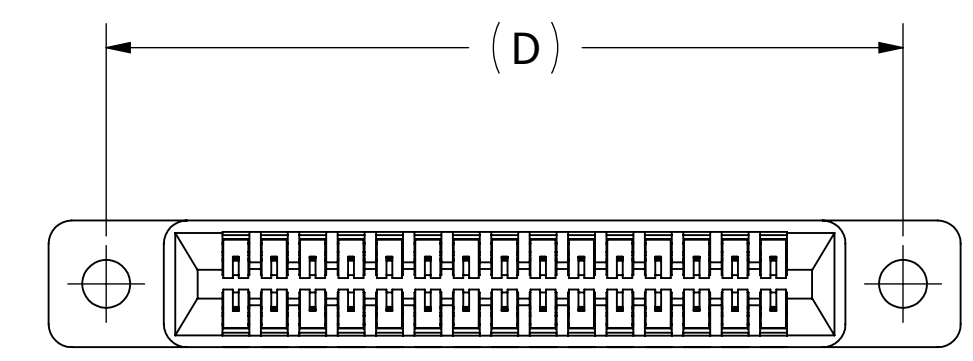

__ C __ HRES

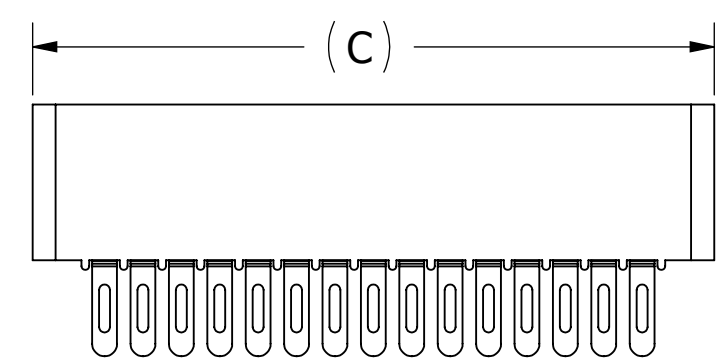
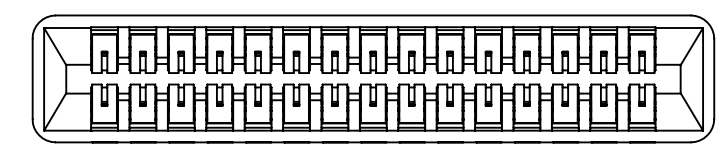

__ C __ HREN

2X FLOATING BOBBIN
Ø.116 [2.95] CLEARANCE
FOR # 4 SCREW

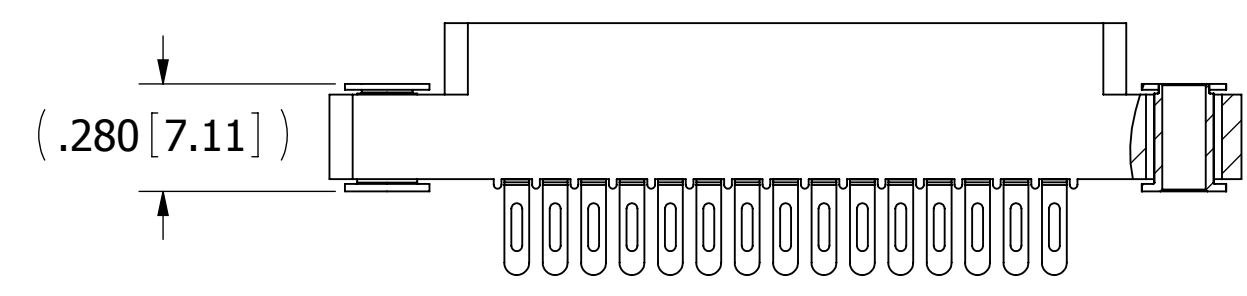
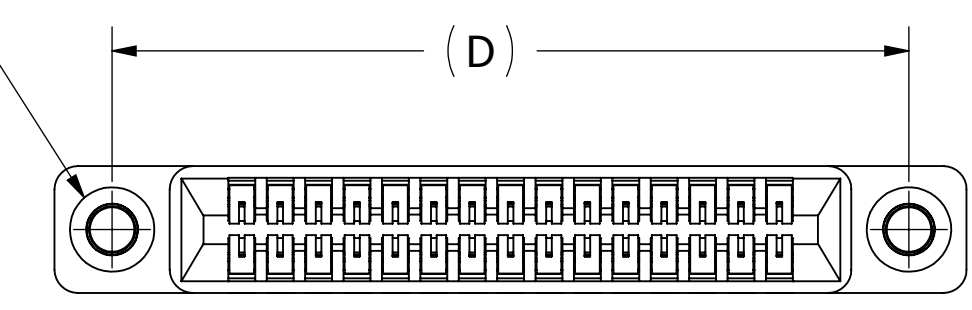

__ C __ HREF

(.065 [1.65])

(.065 [1.65])

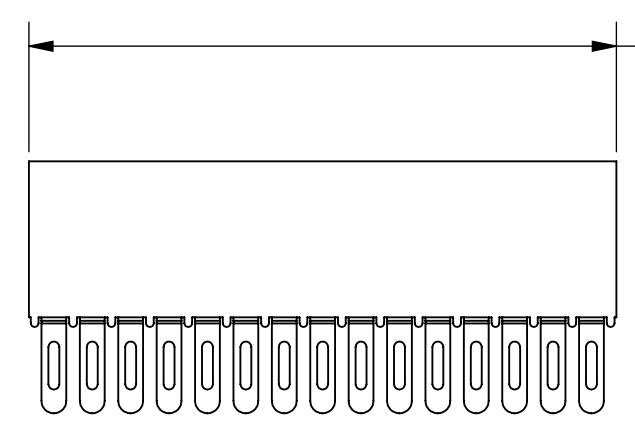
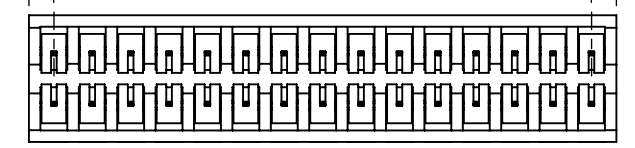

OVERALL LENGTH ±.015 [0.38]
(OVERALL LENGTH = 'A' DIM+.130 [3.30])

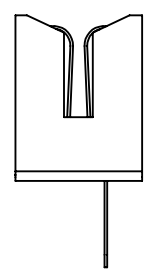

__ C __ HREB

CUSTOMER COPY



UNLESS OTHERWISE SPECIFIED: DIMENSIONS ARE IN INCHES [MM]		DRAWN	DATE	NAME	
TOLERANCES: ANGULAR: ± 1° DECIMALS .XX = ± .02 [.5] .XXX = ± .005 [.13] .XXXX = ± .0005 [.013]		11/14/2011	JH	JH	
<small>THE INFORMATION HEREIN CONTAINS PROPRIETARY INFORMATION OF SULLINS ELECTRONICS AND IS NOT TO BE REPRODUCED, USED OR DISCLOSED TO OTHERS FOR ANY PURPOSE EXCEPT AS SPECIFICALLY AUTHORIZED IN WRITING BY AN OFFICER OF SULLINS ELECTRONICS.</small>					TITLE
					EDGE CARD, .100 CC LP
					PART NUMBER
					__ C __ HRE__
SIZE	CAGE CODE	DWG. NO.		REV	
C	54453	C11917		A	
SCALE: 2:1				SHEET 2 OF 3	

PART NUMBER	NO. OF POS.	A±.008[0.20]		B±.008[0.20]		C±.015[0.38]		D±.010[0.25]		E±.020[0.51]		F+.005[0.13] -.015[0.38]	
		IN	MM	IN	MM	IN	MM	IN	MM	IN	MM	IN	MM
C04HRE	4	0.300	7.62	0.500	12.70	0.675	17.15	0.975	24.77	1.275	32.39	0.330	8.38
C05HRE	5	0.400	10.16	0.600	15.24	0.775	19.69	1.075	27.31	1.375	34.93		
C06HRE	6	0.500	12.70	0.700	17.78	0.875	22.23	1.175	29.85	1.475	37.47		
C07HRE	7	0.600	15.24	0.800	20.32	0.975	24.77	1.275	32.39	1.575	40.01		
C08HRE	8	0.700	17.78	0.900	22.86	1.075	27.31	1.375	34.93	1.675	42.55		
C10HRE	10	0.900	22.86	1.100	27.94	1.275	32.39	1.575	40.01	1.875	47.63		
C12HRE	12	1.100	27.94	1.300	33.02	1.475	37.47	1.775	45.09	2.075	52.71		
C13HRE	13	1.200	30.48	1.400	35.56	1.575	40.01	1.875	47.63	2.175	55.25		
C15HRE	15	1.400	35.56	1.600	40.64	1.775	45.09	2.075	52.71	2.375	60.33		
C17HRE	17	1.600	40.64	1.800	45.72	1.975	50.17	2.275	57.79	2.575	65.41		
C18HRE	18	1.700	43.18	1.900	48.26	2.075	52.71	2.375	60.33	2.675	67.95		
C19HRE	19	1.800	45.72	2.000	50.80	2.175	55.25	2.475	62.87	2.775	70.49		
C20HRE	20	1.900	48.26	2.100	53.34	2.275	57.79	2.575	65.41	2.875	73.03		
C22HRE	22	2.100	53.34	2.300	58.42	2.475	62.87	2.775	70.49	3.075	78.11		
C23HRE	23	2.200	55.88	2.400	60.96	2.575	65.41	2.875	73.03	3.175	80.65		
C25HRE	25	2.400	60.96	2.600	66.04	2.775	70.49	3.075	78.11	3.375	85.73		
C26HRE	26	2.500	63.50	2.700	68.58	2.875	73.03	3.175	80.65	3.475	88.27		
C28HRE	28	2.700	68.58	2.900	73.66	3.075	78.11	3.375	85.73	3.675	93.35		
C30HRE	30	2.900	73.66	3.100	78.74	3.275	83.19	3.575	90.81	3.875	98.43		
C31HRE	31	3.000	76.20	3.200	81.28	3.375	85.73	3.675	93.35	3.975	100.97		
C35HRE	35	3.400	86.36	3.600	91.44	3.775	95.89	4.075	103.51	4.375	111.13		
C36HRE	36	3.500	88.90	3.700	93.98	3.875	98.43	4.175	106.05	4.475	113.67		
C38HRE	38	3.700	93.98	"B" MOUNTING ONLY									
C40HRE	40	3.900	99.06	4.100	104.14	4.275	108.59	4.575	116.21	4.875	123.83		
C43HRE	43	4.200	106.68	4.400	111.76	4.575	116.21	4.875	123.83	5.175	131.45		
C44HRE	44	4.300	109.22	4.500	114.30	4.675	118.75	4.975	126.37	5.275	133.99		
C49HRE	49	4.800	121.92	5.000	127.00	5.175	131.45	5.475	139.07	5.775	146.69		
C50HRE	50	4.900	124.46	5.100	129.54	5.275	133.99	5.575	141.61	5.875	149.23		
C52HRE	52	5.100	129.54	5.300	134.62	5.475	139.07	5.775	146.69	6.075	154.31		
C60HRE	60	5.900	149.86	6.100	154.94	6.275	159.39	6.575	167.01	6.875	174.63		
C65HRE	65	6.400	162.56	6.600	167.64	6.775	172.09	7.075	179.71	7.375	187.33		

PART NUMBER CODING

MATERIAL (INSULATOR/CONTACT)

- E = PBT/PHOSPHOR BRONZE**
OPERATING TEMP: -65°C TO +125°C
PROCESSING TEMP: 260°C FOR 10 SECS MAX
- R = PPS/PHOSPHOR BRONZE**
OPERATING TEMP: -65°C TO +125°C
PROCESSING TEMP: 260°C FOR 120 SECS MAX
- G = PA9T/PHOSPHOR BRONZE**
OPERATING TEMP: -65°C TO +125°C
PROCESSING TEMP: 260°C FOR 20 SECS MAX
- H = PBT/BERYLLIUM COPPER**
OPERATING TEMP: -65°C TO +125°C
PROCESSING TEMP: 260°C FOR 10 SECS MAX
- A = PPS/BERYLLIUM COPPER**
OPERATING TEMP: -65°C TO +150°C
PROCESSING TEMP: 260°C FOR 120 SECS MAX
- J = PA9T/BERYLLIUM COPPER**
OPERATING TEMP: -65°C TO +150°C
PROCESSING TEMP: 260°C FOR 20 SECS MAX
- F = PPS/SPINODAL (CONSULT FACTORY)**
OPERATING TEMP: -65°C TO +200°C
PROCESSING TEMP: 260°C FOR 120 SECS MAX
AVAILABLE IN OVERALL GOLD ONLY (S OR M PLATING CODE)
- C = PPS/BERYLLIUM NICKEL (CONSULT FACTORY)**
OPERATING TEMP: -65°C TO +200°C
PROCESSING TEMP: 260°C FOR 120 SECS MAX
AVAILABLE IN OVERALL GOLD ONLY (S OR M PLATING CODE)
- W = PEEK/BERYLLIUM NICKEL (CONSULT FACTORY)**
OPERATING TEMP: -65°C TO +250°C
AVAILABLE IN OVERALL GOLD ONLY (S OR M PLATING CODE)

MOUNTING STYLE

- H = .125" DIA. CLEARANCE HOLES (PAGE 1)
- I = #4-40 THREADED INSERT (PAGE 2)
- S = .125" DIA. SIDE MOUNTING (PAGE 2)
- N = NO MOUNTING EARS (PAGE 2)
- F = FLOATING BOBBIN (PAGE 2)
- B = OPEN CARD SLOT (PAGE 2)

NUMBER OF POSITIONS (CONTACTS PER ROW)

PLATING

- ALL PLATINGS HAVE .000050" NICKEL UNDERPLATE
- | | |
|--|--------------------------|
| CONTACT SURFACE | TERMINATION |
| G = .000010" GOLD | .000005" GOLD |
| Y = .000030" GOLD | .000005" GOLD |
| B = .000010" GOLD | .000100" PURE TIN, MATTE |
| C = .000030" GOLD | .000100" PURE TIN, MATTE |
| **E = .000100" PURE TIN, MATTE, OVERALL | |
| S = .000010" GOLD OVERALL | |
| M = .000030" GOLD | .000010" GOLD OVERALL |
| ** OVERALL TIN ONLY AVAILABLE ON MATERIAL CODES E, R AND G | |

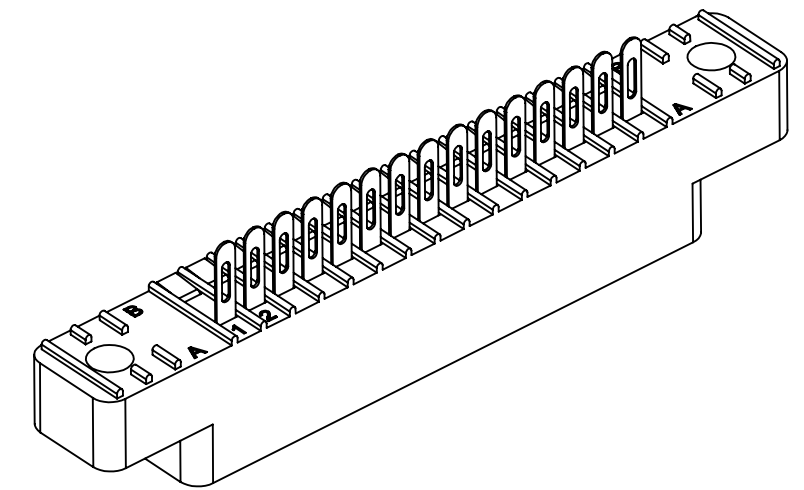

CUSTOMER COPY

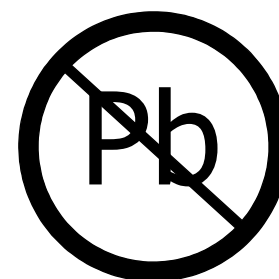

RoHS COMPLIANT

UNLESS OTHERWISE SPECIFIED: DIMENSIONS ARE IN INCHES [MM]		DRAWN	DATE	NAME		
			11/14/2011	JH		
TOLERANCES:					THE INFORMATION HEREIN CONTAINS PROPRIETARY INFORMATION OF SULLINS ELECTRONICS AND IS NOT TO BE REPRODUCED, USED OR DISCLOSED TO OTHERS FOR ANY PURPOSE EXCEPT AS SPECIFICALLY AUTHORIZED IN WRITING BY AN OFFICER OF SULLINS ELECTRONICS.	
ANGULAR: ± 1°					TITLE EDGE CARD, .100 CC LP	
DECIMALS .XX = ± .02 [.5] .XXX = ± .005 [.13] .XXXX = ± .0005 [.013]					PART NUMBER _C_ _HRE_	
SCALE: 2:1		SIZE C	CAGE CODE 54453	DWG. NO. C11917	REV A	
					SHEET 3 OF 3	