

## MIRELLA-50-M

~30° medium beam

### SPECIFICATION:

Dimensions	Ø 49.9 mm
Height	23.9 mm
Fastening	glue
ROHS compliant	yes ⓘ

### MATERIALS:

Component	Type	Material	Colour	Finish	Coating
MIRELLA-50-M	Reflector	PC	metal		lacquer

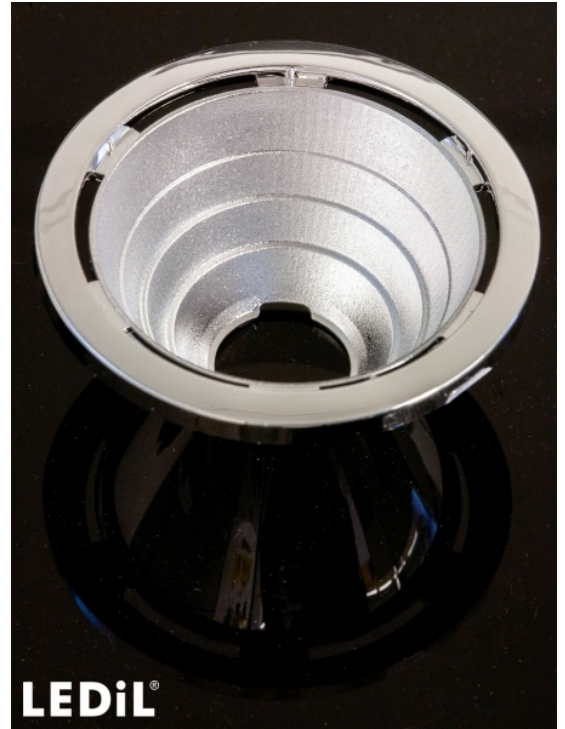





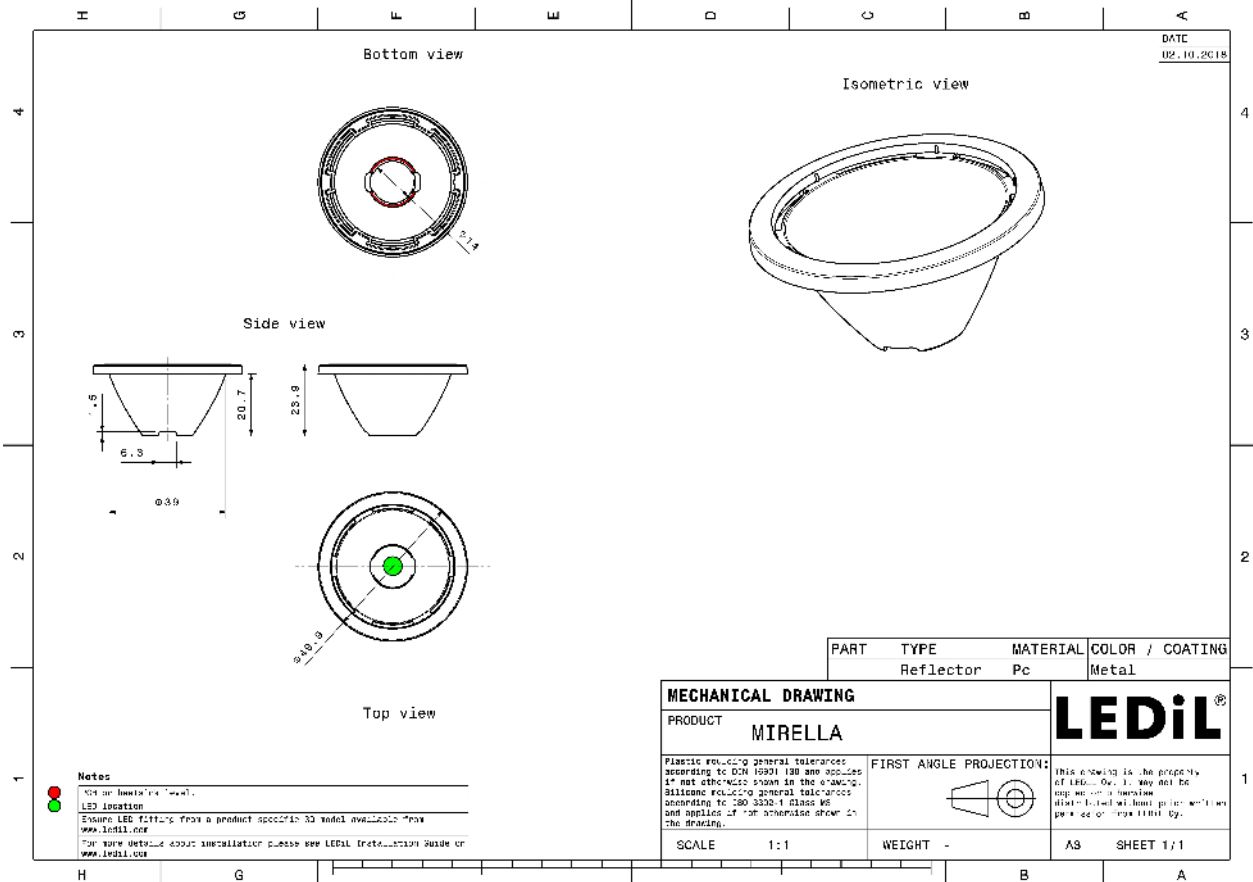

### ORDERING INFORMATION:

Component	Qty in box	MOQ	MPQ	Box weight (kg)
C12477_MIRELLA-50-M » Box size: 480 x 280 x 300 mm	336	112	28	2.8

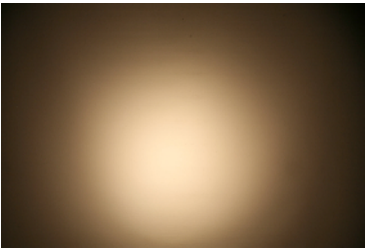
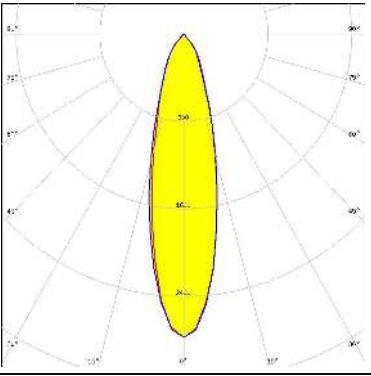

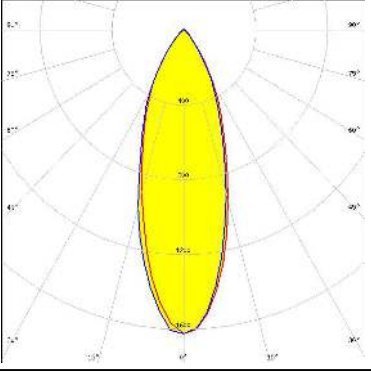
See also our general installation guide: [www.ledil.com/installation\\_guide](http://www.ledil.com/installation_guide)

#### OPTICAL RESULTS (MEASURED):

<p></p> <p>LED BXRA LS            FWHM / FWTM 27.0° / 64.0°            Efficiency 89 %            Peak intensity 2.8 cd/lm            LEDs/each optic 1            Light colour White            Required components:</p>		
<p></p> <p>LED BXRA LS            FWHM / FWTM 35.0° / 73.0°            Efficiency 83 %            Peak intensity 1.6 cd/lm            LEDs/each optic 1            Light colour White            Required components:            C12479_MIRELLA-DL</p>		
<p></p> <p>LED BXRA LS            FWHM / FWTM 27.0° / 69.0°            Efficiency 84 %            Peak intensity 2.4 cd/lm            LEDs/each optic 1            Light colour White            Required components:            C13333_MIRELLA-CL</p>		
<p><b>CITIZEN</b></p> <p>LED CLL01x            FWHM / FWTM 35.0° / 76.0°            Efficiency 83 %            Peak intensity 1.7 cd/lm            LEDs/each optic 1            Light colour White            Required components:            C13333_MIRELLA-CL</p>		

#### OPTICAL RESULTS (MEASURED):

#### CITIZEN

LED CLL01x  
 FWHM / FWTM 29.0° / 77.0°  
 Efficiency %  
 Peak intensity 3.2 cd/m  
 LEDs/each optic 1  
 Light colour White  
 Required components:

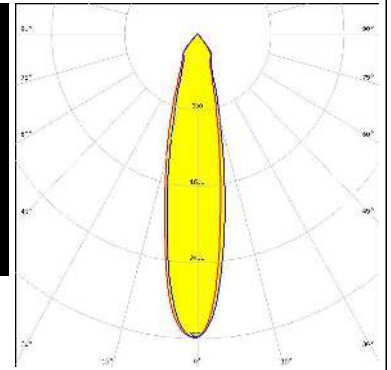
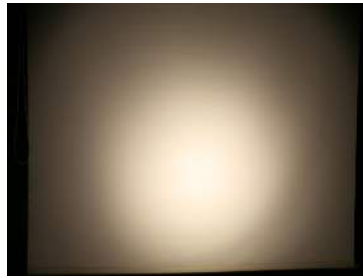

#### CITIZEN

LED CLL01x  
 FWHM / FWTM 39.0° / 77.0°  
 Efficiency %  
 LEDs/each optic 1  
 Light colour White  
 Required components:  
 C12479\_MIRELLA-DL



#### CITIZEN

LED CLL02x/CLU02x (LES10)  
 FWHM / FWTM 30.0° / 71.0°  
 Efficiency 88 %  
 Peak intensity 2.4 cd/m  
 LEDs/each optic 1  
 Light colour White  
 Required components:

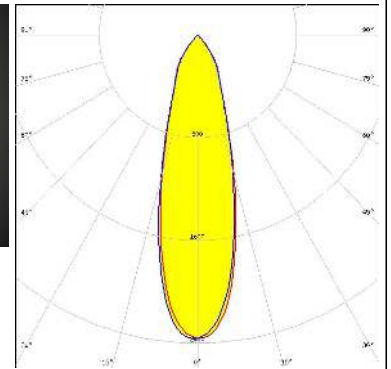
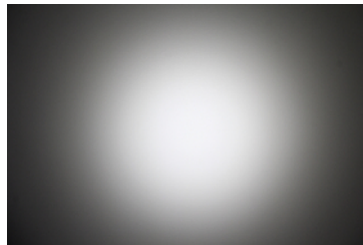

#### CITIZEN

LED CLL02x/CLU02x (LES10)  
 FWHM / FWTM 30.0° / 71.0°  
 Efficiency 84 %  
 Peak intensity 2.2 cd/m  
 LEDs/each optic 1  
 Light colour White  
 Required components:  
 C13333\_MIRELLA-CL

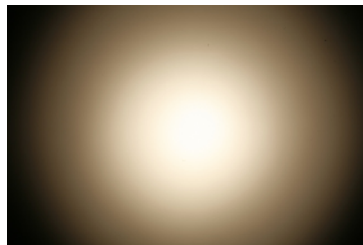

#### OPTICAL RESULTS (MEASURED):

#### CITIZEN

LED CLL02x/CLU02x (LES10)  
 FWHM / FWTM 35.0° / 73.0°  
 Efficiency 82 %  
 Peak intensity 1.7 cd/m  
 LEDs/each optic 1  
 Light colour White  
 Required components:  
 C12479\_MIRELLA-DL

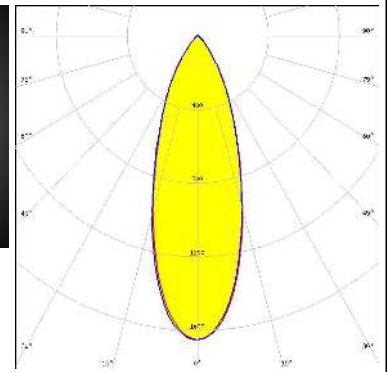
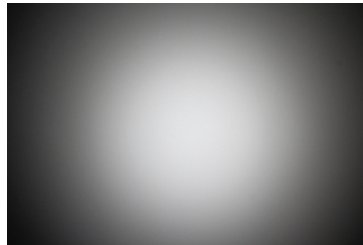

#### CITIZEN

LED CLL02x/CLU02x (LES10)  
 FWHM / FWTM 37.0° / 75.0°  
 Efficiency 82 %  
 Peak intensity 1.6 cd/m  
 LEDs/each optic 1  
 Light colour White  
 Required components:  
 C13723\_MIRELLA-RZL

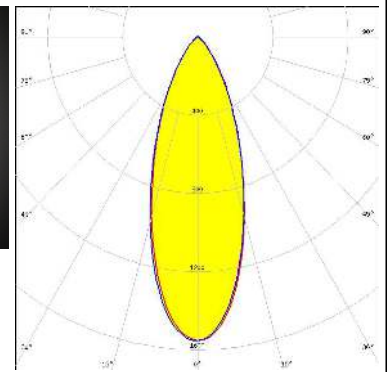
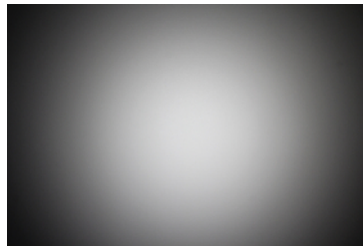

#### CITIZEN

LED CLU700/701/702/703  
 FWHM / FWTM 29.0° / 69.0°  
 Efficiency 84 %  
 Peak intensity 2.2 cd/m  
 LEDs/each optic 1  
 Light colour White  
 Required components:  
 C12479\_MIRELLA-DL

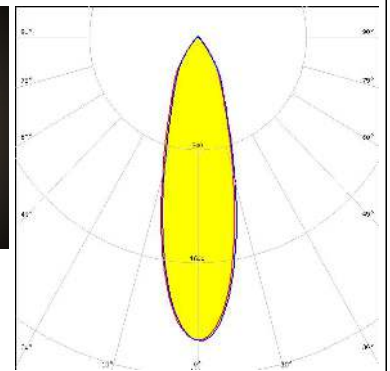
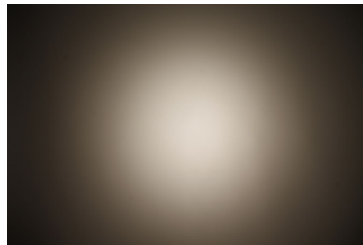

#### CITIZEN

LED CLU700/701/702/703  
 FWHM / FWTM 24.0° / 64.0°  
 Efficiency 83 %  
 Peak intensity 2.9 cd/m  
 LEDs/each optic 1  
 Light colour White  
 Required components:  
 C13333\_MIRELLA-CL

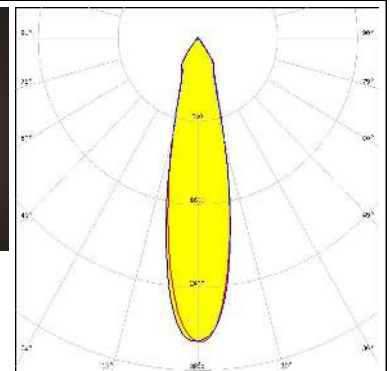
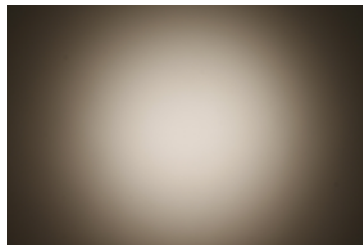

#### OPTICAL RESULTS (MEASURED):

#### CITIZEN

LED CLU700/701/702/703  
 FWHM / FWTM 33.0° / 70.0°  
 Efficiency 82 %  
 Peak intensity 1.7 cd/m  
 LEDs/each optic 1  
 Light colour White  
 Required components:  
 C13723\_MIRELLA-RZL

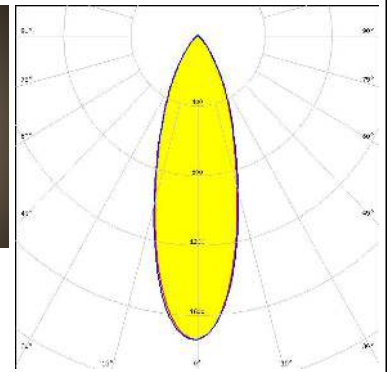

#### CITIZEN

LED CLU700/701/702/703  
 FWHM / FWTM 22.0° / 51.0°  
 Efficiency 90 %  
 Peak intensity 3.5 cd/m  
 LEDs/each optic 1  
 Light colour White  
 Required components:

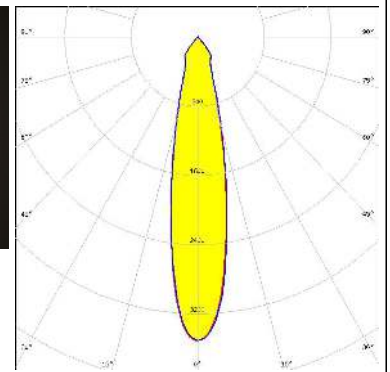
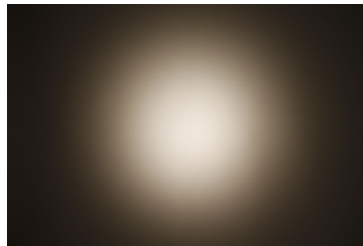

#### CITIZEN

LED CLU710/711  
 FWHM / FWTM 26.0° / 70.0°  
 Efficiency 90 %  
 Peak intensity 2.6 cd/m  
 LEDs/each optic 1  
 Light colour White  
 Required components:

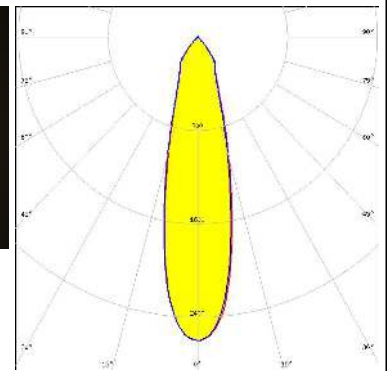
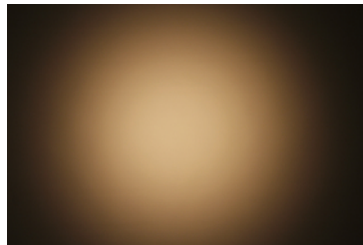

#### CITIZEN

LED CLU710/711  
 FWHM / FWTM 35.0° / 74.0°  
 Efficiency 81 %  
 Peak intensity 1.5 cd/m  
 LEDs/each optic 1  
 Light colour White  
 Required components:  
 C12479\_MIRELLA-DL

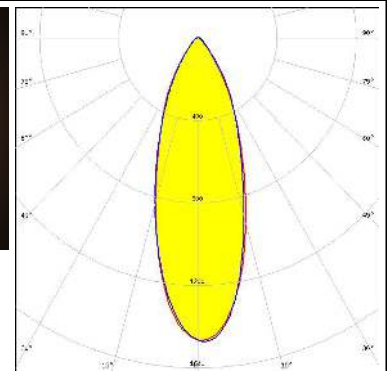
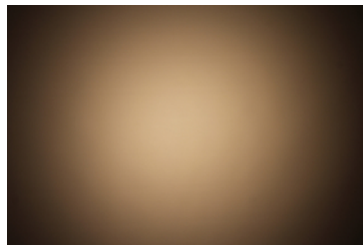

#### OPTICAL RESULTS (MEASURED):

#### CITIZEN

LED CLU710/711  
 FWHM / FWTM 30.0° / 70.0°  
 Efficiency 85 %  
 Peak intensity 2.1 cd/lm  
 LEDs/each optic 1  
 Light colour White  
 Required components:  
 C13333\_MIRELLA-CL

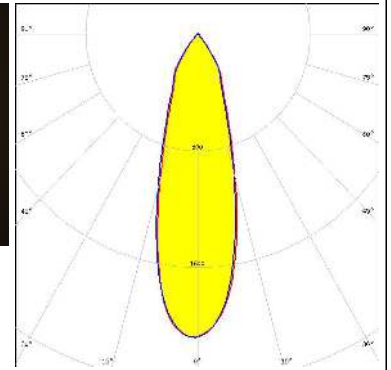

#### CITIZEN

LED CLU710/711  
 FWHM / FWTM 38.0° / 76.0°  
 Efficiency 83 %  
 Peak intensity 1.4 cd/lm  
 LEDs/each optic 1  
 Light colour White  
 Required components:  
 C13723\_MIRELLA-RZL

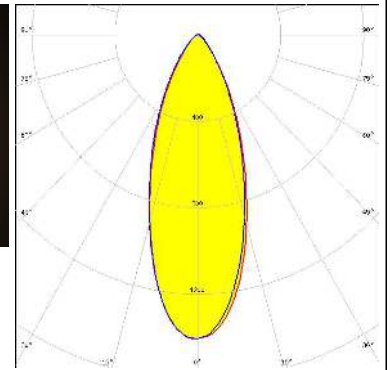
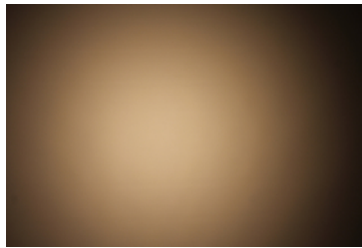

#### CITIZEN

LED CLU720/721/723  
 FWHM / FWTM 31.0° / 75.0°  
 Efficiency 90 %  
 Peak intensity 2 cd/lm  
 LEDs/each optic 1  
 Light colour White  
 Required components:

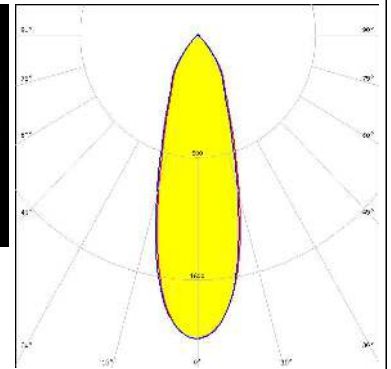
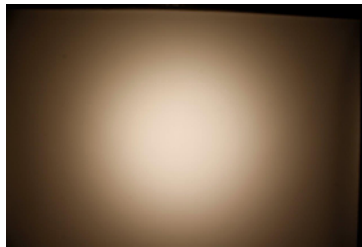

#### CITIZEN

LED CLU720/721/723  
 FWHM / FWTM 38.0° / 76.0°  
 Efficiency 82 %  
 Peak intensity 1.4 cd/lm  
 LEDs/each optic 1  
 Light colour White  
 Required components:  
 C12479\_MIRELLA-DL

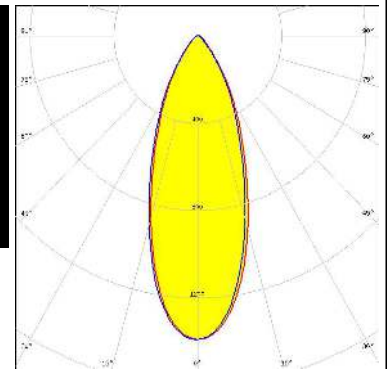
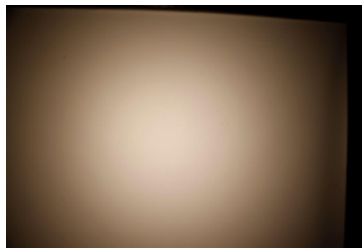

#### OPTICAL RESULTS (MEASURED):

#### CITIZEN

LED CLU720/721/723  
 FWHM / FWTM 35.0° / 73.0°  
 Efficiency 85 %  
 Peak intensity 1.7 cd/lm  
 LEDs/each optic 1  
 Light colour White  
 Required components:  
 C13333\_MIRELLA-CL

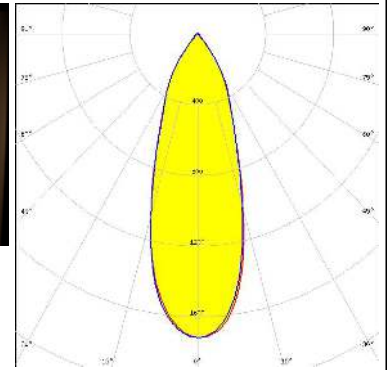
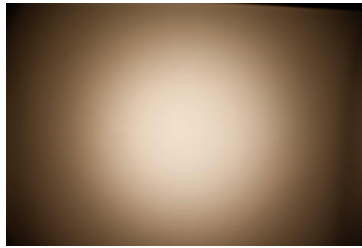

#### CITIZEN

LED CLU720/721/723  
 FWHM / FWTM 39.0° / 77.0°  
 Efficiency 83 %  
 Peak intensity 1.4 cd/lm  
 LEDs/each optic 1  
 Light colour White  
 Required components:  
 C13723\_MIRELLA-RZL

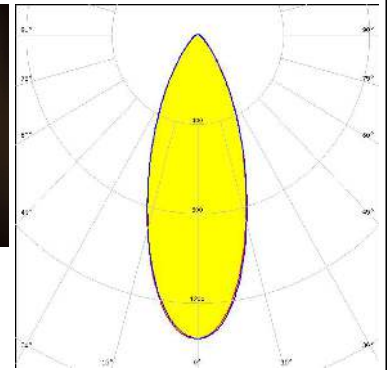
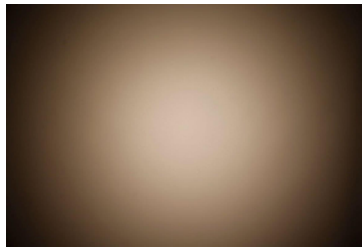

#### CREE LED

LED CXA/B 13xx  
 FWHM / FWTM 26.0° / 67.0°  
 Efficiency 80 %  
 Peak intensity 2.4 cd/lm  
 LEDs/each optic 1  
 Light colour White  
 Required components:  
 C12479\_MIRELLA-DL



#### CREE LED

LED CXA/B 13xx  
 FWHM / FWTM 23.0° / 68.0°  
 Efficiency 81 %  
 Peak intensity 2.9 cd/lm  
 LEDs/each optic 1  
 Light colour White  
 Required components:  
 C13333\_MIRELLA-CL



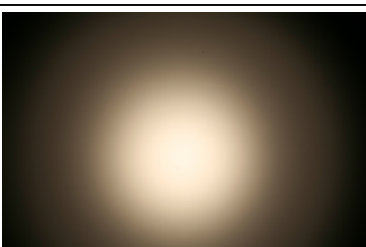
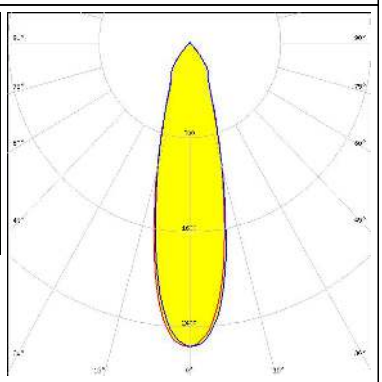
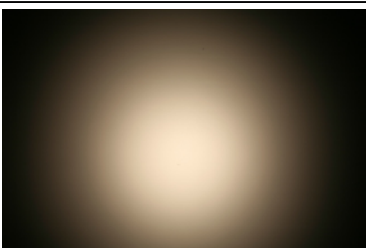
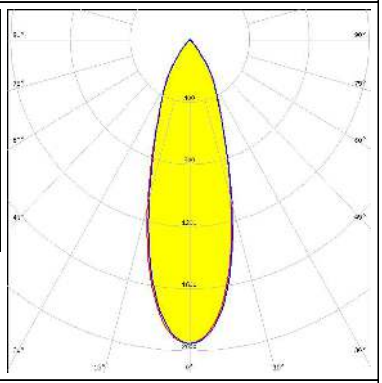
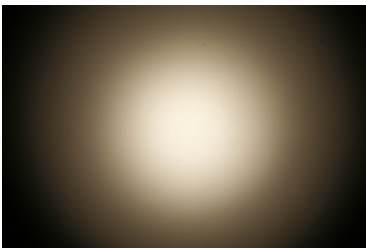

#### OPTICAL RESULTS (MEASURED):

<p><b>CREE</b> ⇄ <b>LED</b></p> <p>LED CXA/B 13xx            FWHM / FWTM 20.0° / 55.0°            Efficiency 85 %            Peak intensity 3.7 cd/lm            LEDs/each optic 1            Light colour White            Required components:</p>		
<p><b>CREE</b> ⇄ <b>LED</b></p> <p>LED CXA/B 15xx            FWHM / FWTM 28.0° / 72.0°            Efficiency 92 %            Peak intensity 2.5 cd/lm            LEDs/each optic 1            Light colour White            Required components:</p>		
<p><b>CREE</b> ⇄ <b>LED</b></p> <p>LED CXA/B 15xx            FWHM / FWTM 34.0° / 72.0°            Efficiency 89 %            Peak intensity 1.7 cd/lm            LEDs/each optic 1            Light colour White            Required components:            C12479_MIRELLA-DL</p>		
<p><b>CREE</b> ⇄ <b>LED</b></p> <p>LED CXA/B 15xx            FWHM / FWTM 30.0° / 71.0°            Efficiency 83 %            Peak intensity 2.4 cd/lm            LEDs/each optic 1            Light colour White            Required components:            C13333_MIRELLA-CL</p>		

#### OPTICAL RESULTS (MEASURED):

##### CREE LED

LED CXA/B 1816 & CXA/B 1820 & CXA 1850  
 FWHM / FWTM 34.0° / 78.0°  
 Efficiency 88 %  
 Peak intensity 2 cd/lm  
 LEDs/each optic 1  
 Light colour White  
 Required components:

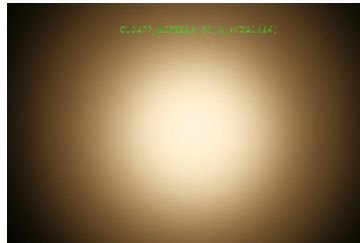

##### CREE LED

LED CXA/B 1816 & CXA/B 1820 & CXA 1850  
 FWHM / FWTM 39.0° / 76.0°  
 Efficiency 83 %  
 Peak intensity 1.6 cd/lm  
 LEDs/each optic 1  
 Light colour White  
 Required components:  
 C12479\_MIRELLA-DL

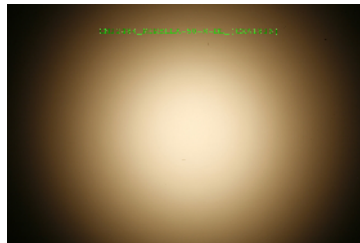

##### CREE LED

LED CXA/B 1816 & CXA/B 1820 & CXA 1850  
 FWHM / FWTM 37.0° / 76.0°  
 Efficiency 82 %  
 Peak intensity 1.8 cd/lm  
 LEDs/each optic 1  
 Light colour White  
 Required components:  
 C13333\_MIRELLA-CL





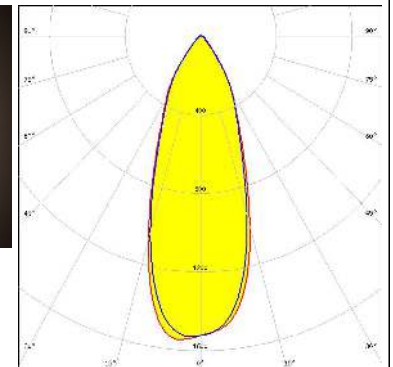
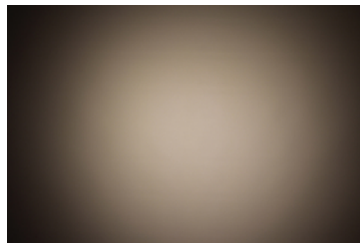

##### CREE LED

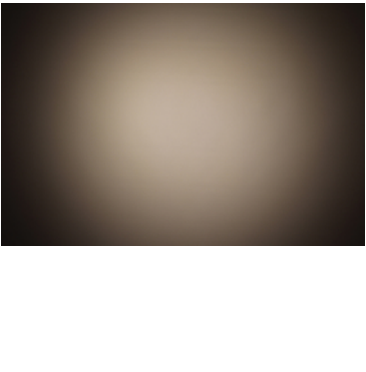
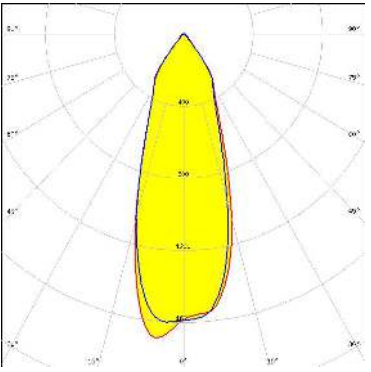
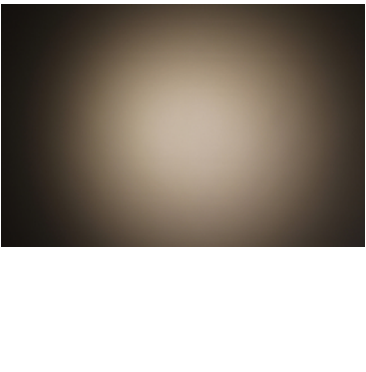
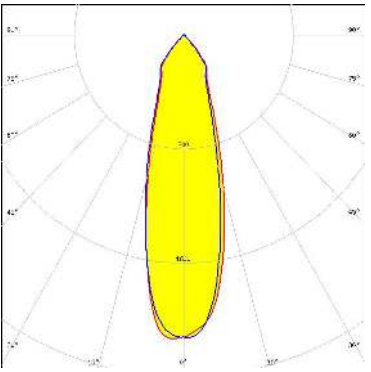

LED MHD-E/G  
 FWHM / FWTM 37.0° / 76.0°  
 Efficiency 88 %  
 Peak intensity 1.5 cd/lm  
 LEDs/each optic 1  
 Light colour White  
 Required components:  
 C12479\_MIRELLA-DL

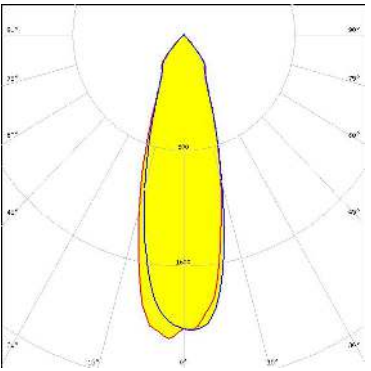

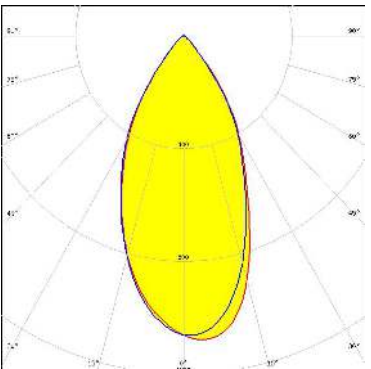

#### OPTICAL RESULTS (MEASURED):

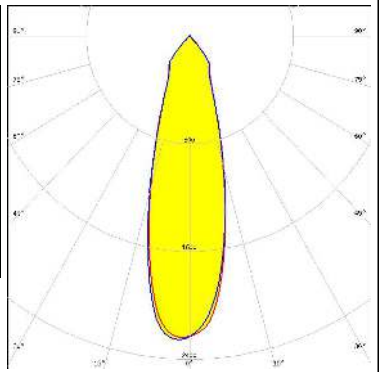
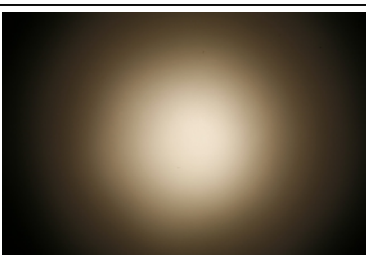
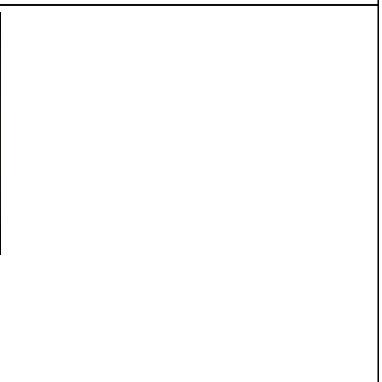
<p><b>CREE</b> ⇄ <b>LED</b></p> <p>LED MHD-E/G            FWHM / FWTM 35.0° / 76.0°            Efficiency 88 %            Peak intensity 1.7 cd/lm            LEDs/each optic 1            Light colour White            Required components:            C13333_MIRELLA-CL</p>		
<p><b>CREE</b> ⇄ <b>LED</b></p> <p>LED MHD-E/G            FWHM / FWTM 30.0° / 79.0°            Efficiency 93 %            Peak intensity 2.1 cd/lm            LEDs/each optic 1            Light colour White            Required components:</p>		
<p><b>CREE</b> ⇄ <b>LED</b></p> <p>LED MT-G            FWHM / FWTM 31.0° / 78.5°            Efficiency 91 %            Peak intensity 2.1 cd/lm            LEDs/each optic 1            Light colour White            Required components:</p>		
<p><b>CREE</b> ⇄ <b>LED</b></p> <p>LED MT-G2            FWHM / FWTM 38.0° / 77.0°            Efficiency 83 %            Peak intensity 1.7 cd/lm            LEDs/each optic 1            Light colour White            Required components:            C12479_MIRELLA-DL</p>		

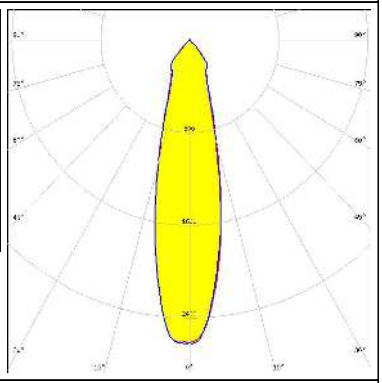
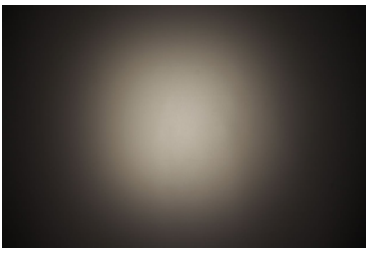
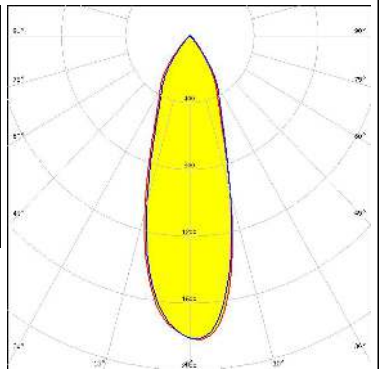

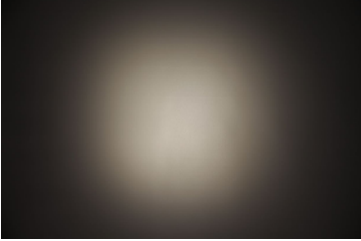
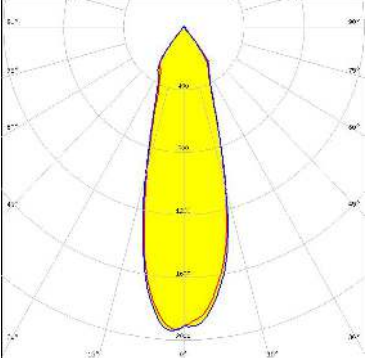

#### OPTICAL RESULTS (MEASURED):

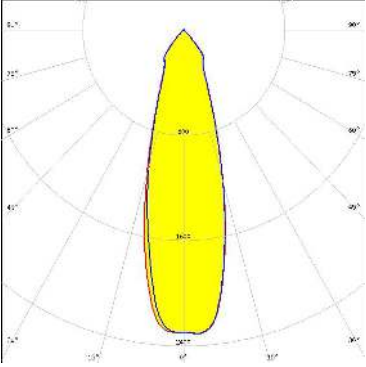
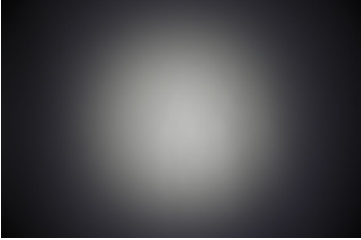
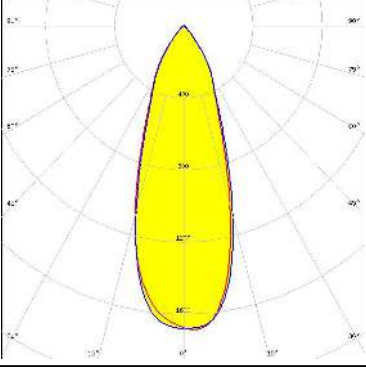
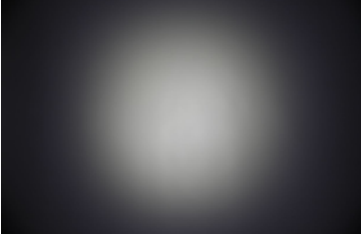
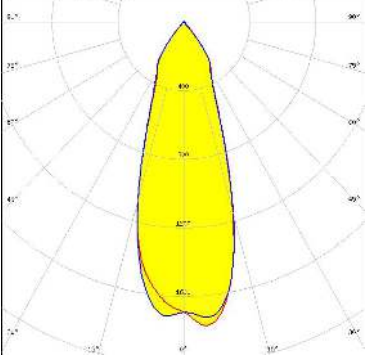
<p><b>CREE → LED</b></p> <p>LED MT-G2            FWHM / FWTM 30.0° / 78.0°            Efficiency 90 %            Peak intensity 2.3 cd/lm            LEDs/each optic 1            Light colour White            Required components:</p>		
<p><b>CREE → LED</b></p> <p>LED MT-G2            FWHM / FWTM 35.0° / 77.0°            Efficiency 85 %            Peak intensity 1.8 cd/lm            LEDs/each optic 1            Light colour White            Required components:            C13333_MIRELLA-CL</p>		
<p><b>CREE → LED</b></p> <p>LED XHP50            FWHM / FWTM 25.0° / 76.0°            Efficiency 91 %            Peak intensity 2.6 cd/lm            LEDs/each optic 1            Light colour White            Required components:</p>		
<p><b>CREE → LED</b></p> <p>LED XHP50            FWHM / FWTM 33.0° / 74.0°            Efficiency 86 %            Peak intensity 1.8 cd/lm            LEDs/each optic 1            Light colour White            Required components:            C12479_MIRELLA-DL</p>		

#### OPTICAL RESULTS (MEASURED):

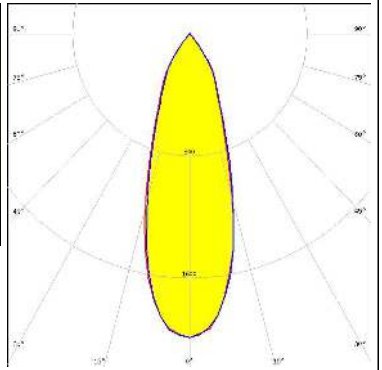
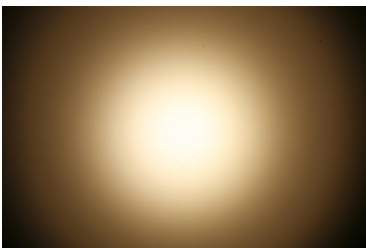
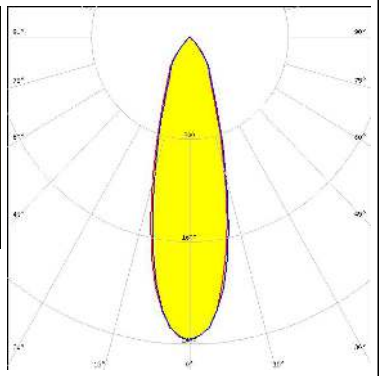
<p><b>CREE</b> ⇄ <b>LED</b></p> <p>LED XHP50            FWHM / FWTM 31.0° / 75.0°            Efficiency 86 %            Peak intensity 2 cd/lm            LEDs/each optic 1            Light colour White            Required components:            C13333_MIRELLA-CL</p>		
<p><b>CREE</b> ⇄ <b>LED</b></p> <p>LED XHP70            FWHM / FWTM 30.0° / 77.0°            Efficiency 91 %            Peak intensity 2.3 cd/lm            LEDs/each optic 1            Light colour White            Required components:</p>		
<p><b>CREE</b> ⇄ <b>LED</b></p> <p>LED XHP70            FWHM / FWTM 36.0° / 74.0°            Efficiency 87 %            Peak intensity 1.7 cd/lm            LEDs/each optic 1            Light colour White            Required components:            C12479_MIRELLA-DL</p>		
<p><b>CREE</b> ⇄ <b>LED</b></p> <p>LED XHP70            FWHM / FWTM 35.0° / 76.0°            Efficiency 86 %            Peak intensity 1.8 cd/lm            LEDs/each optic 1            Light colour White            Required components:            C13333_MIRELLA-CL</p>		

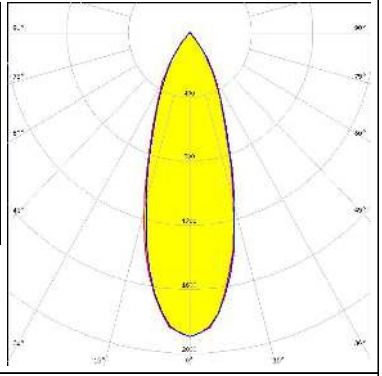
#### OPTICAL RESULTS (MEASURED):

<p><b>LUMILEDS</b></p> <p>LED LUXEON CoB 1202/1203</p> <p>FWHM / FWTM 33.0° / 72.0°</p> <p>Efficiency 85 %</p> <p>Peak intensity 2 cd/lm</p> <p>LEDs/each optic 1</p> <p>Light colour White</p> <p>Required components: C13333_MIRELLA-CL</p>		
<p><b>LUMILEDS</b></p> <p>LED LUXEON CoB 1202/1203</p> <p>FWHM / FWTM 29.0° / 72.0°</p> <p>Efficiency 89 %</p> <p>Peak intensity 2.4 cd/lm</p> <p>LEDs/each optic 1</p> <p>Light colour White</p> <p>Required components:</p>		
<p><b>LUMILEDS</b></p> <p>LED LUXEON CoB 1202/1203</p> <p>FWHM / FWTM 35.0° / 71.0°</p> <p>Efficiency 85 %</p> <p>Peak intensity 1.9 cd/lm</p> <p>LEDs/each optic 1</p> <p>Light colour White</p> <p>Required components: C12479_MIRELLA-DL</p>		
<p><b>LUMILEDS</b></p> <p>LED LUXEON S1000</p> <p>FWHM / FWTM 28.0° / 68.0°</p> <p>Efficiency %</p> <p>LEDs/each optic 1</p> <p>Light colour White</p> <p>Required components: C12479_MIRELLA-DL</p>		

#### OPTICAL RESULTS (MEASURED):

##### LUMILEDS

LED LUXEON S1000  
 FWHM / FWTM 22.0° / 64.0°  
 Efficiency 83 %  
 Peak intensity 3.4 cd/m  
 LEDs/each optic 1  
 Light colour White  
 Required components:  
 C13333\_MIRELLA-CL



##### LUMILEDS

LED LUXEON S1000  
 FWHM / FWTM 22.0° / 66.0°  
 Efficiency %  
 LEDs/each optic 1  
 Light colour White  
 Required components:



##### LUMINUS

LED CxM-9 (13.5x13.5)  
 FWHM / FWTM 34.0° / 72.0°  
 Efficiency 85 %  
 Peak intensity 1.7 cd/m  
 LEDs/each optic 1  
 Light colour White  
 Required components:  
 C12479\_MIRELLA-DL

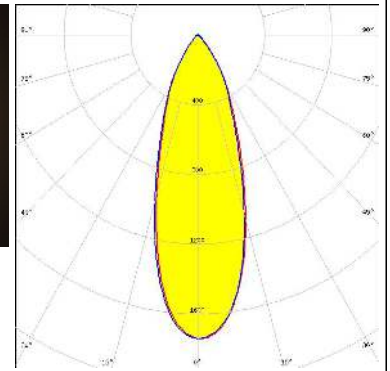
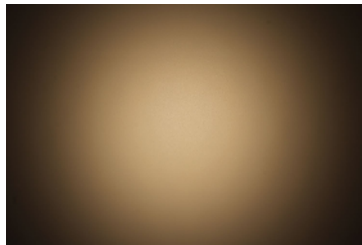



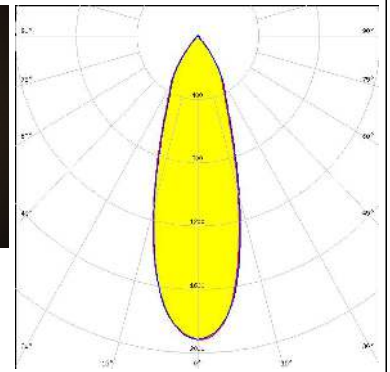
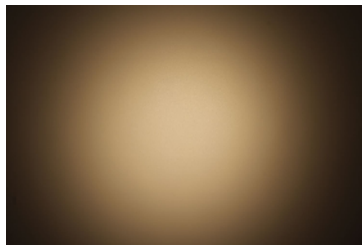

##### LUMINUS

LED CxM-9 (13.5x13.5)  
 FWHM / FWTM 33.0° / 72.0°  
 Efficiency 85 %  
 Peak intensity 1.9 cd/m  
 LEDs/each optic 1  
 Light colour White  
 Required components:  
 C13333\_MIRELLA-CL

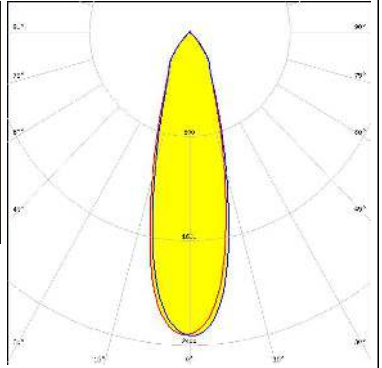

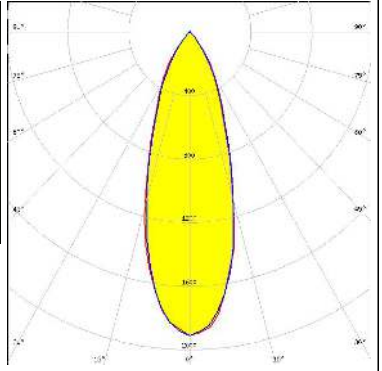
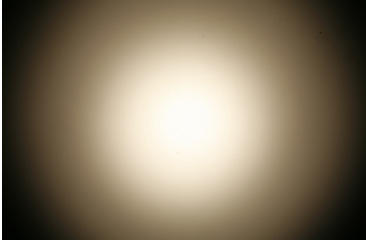
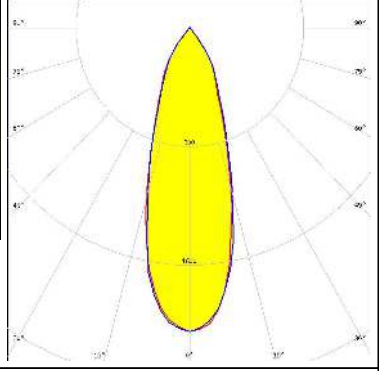

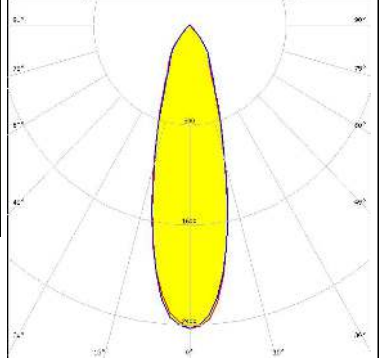



#### OPTICAL RESULTS (MEASURED):

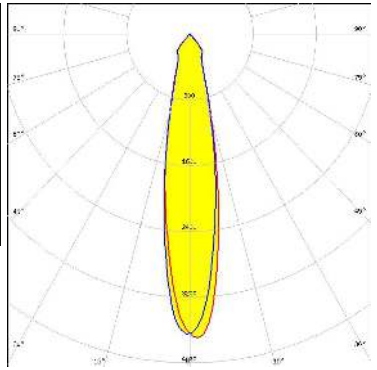

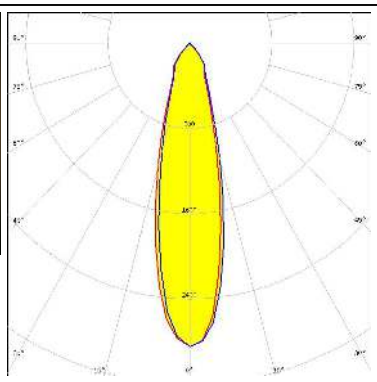
<p><b>LUMINUS</b></p> <p>LED CxM-9 (13.5x13.5)</p> <p>FWHM / FWTM 29.0° / 73.0°</p> <p>Efficiency 90 %</p> <p>Peak intensity 2.3 cd/m</p> <p>LEDs/each optic 1</p> <p>Light colour White</p> <p>Required components:</p>		
<p><b>NICHIA</b></p> <p>LED COB L-Type (LES 9)</p> <p>FWHM / FWTM 34.0° / 71.0°</p> <p>Efficiency 84 %</p> <p>Peak intensity 1.9 cd/m</p> <p>LEDs/each optic 1</p> <p>Light colour White</p> <p>Required components: C12479_MIRELLA-DL</p>		
<p><b>NICHIA</b></p> <p>LED COB L-Type (LES 9)</p> <p>FWHM / FWTM 33.0° / 71.0°</p> <p>Efficiency 86 %</p> <p>Peak intensity 2.1 cd/m</p> <p>LEDs/each optic 1</p> <p>Light colour White</p> <p>Required components: C13333_MIRELLA-CL</p>		
<p><b>NICHIA</b></p> <p>LED COB L-Type (LES 9)</p> <p>FWHM / FWTM 29.0° / 72.0°</p> <p>Efficiency 90 %</p> <p>Peak intensity 2.4 cd/m</p> <p>LEDs/each optic 1</p> <p>Light colour White</p> <p>Required components:</p>		

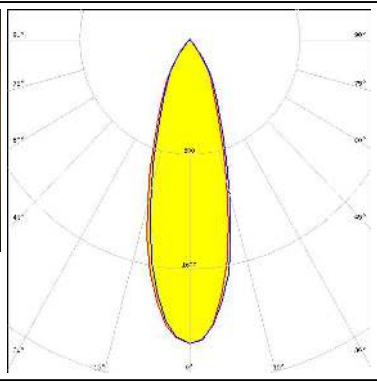

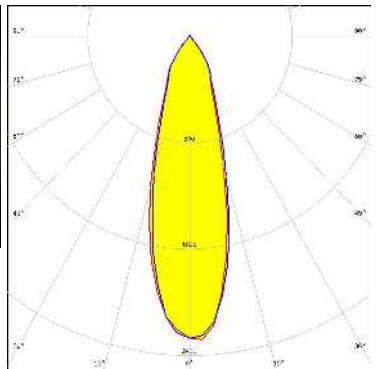

#### OPTICAL RESULTS (MEASURED):

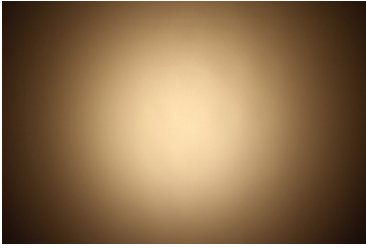
<p><b>NICHIA</b></p> <p>LED NFMW48xA            FWHM / FWTM 21.0° / 53.0°            Efficiency 82 %            Peak intensity 3.3 cd/lm            LEDs/each optic 1            Light colour White            Required components:</p>		
<p><b>NICHIA</b></p> <p>LED NSCxL036A            FWHM / FWTM 26.0° / 64.0°            Efficiency 88 %            Peak intensity 2.8 cd/lm            LEDs/each optic 1            Light colour White            Required components:</p>		
<p><b>NICHIA</b></p> <p>LED NSCxL036A            FWHM / FWTM 32.0° / 70.0°            Efficiency 85 %            Peak intensity 2.1 cd/lm            LEDs/each optic 1            Light colour White            Required components:            C12479_MIRELLA-DL</p>		
<p><b>NICHIA</b></p> <p>LED NSCxL036A            FWHM / FWTM 30.0° / 70.0°            Efficiency 85 %            Peak intensity 2.3 cd/lm            LEDs/each optic 1            Light colour White            Required components:            C13333_MIRELLA-CL</p>		

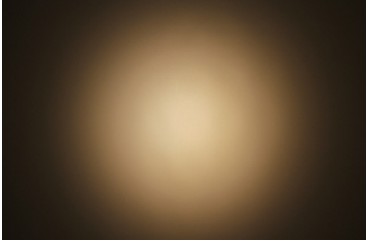
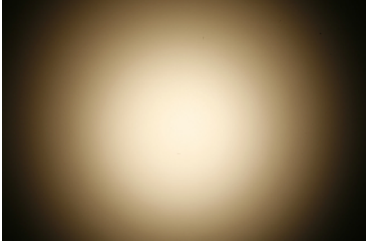
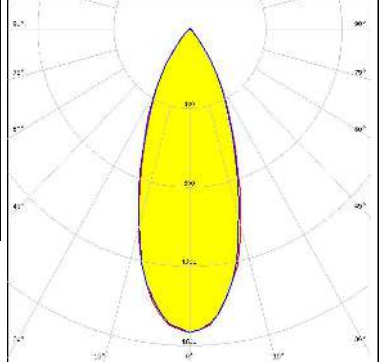
#### OPTICAL RESULTS (MEASURED):

<p><b>OSRAM</b> Opto Semiconductors</p> <p>LED Duris S10</p> <p>FWHM / FWTM 32.0° / 72.0°</p> <p>Efficiency 81 %</p> <p>Peak intensity 1.9 cd/lm</p> <p>LEDs/each optic 1</p> <p>Light colour White</p> <p>Required components: C12479_MIRELLA-DL</p>	
<p><b>OSRAM</b> Opto Semiconductors</p> <p>LED Duris S10</p> <p>FWHM / FWTM 29.0° / 71.0°</p> <p>Efficiency 83 %</p> <p>Peak intensity 2.5 cd/lm</p> <p>LEDs/each optic 1</p> <p>Light colour White</p> <p>Required components: C13333_MIRELLA-CL</p>	
<p><b>OSRAM</b> Opto Semiconductors</p> <p>LED Duris S10</p> <p>FWHM / FWTM 24.0° / 63.0°</p> <p>Efficiency 88 %</p> <p>Peak intensity 3.3 cd/lm</p> <p>LEDs/each optic 1</p> <p>Light colour White</p> <p>Required components:</p>	
<p><b>OSRAM</b> Opto Semiconductors</p> <p>LED Soleriq S13</p> <p>FWHM / FWTM 39.0° / 75.0°</p> <p>Efficiency 81 %</p> <p>Peak intensity 1.5 cd/lm</p> <p>LEDs/each optic 1</p> <p>Light colour White</p> <p>Required components: C12479_MIRELLA-DL</p>	 

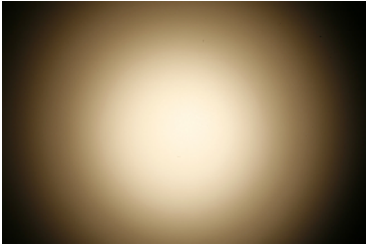
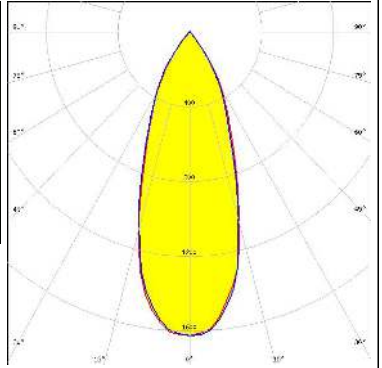
#### OPTICAL RESULTS (MEASURED):

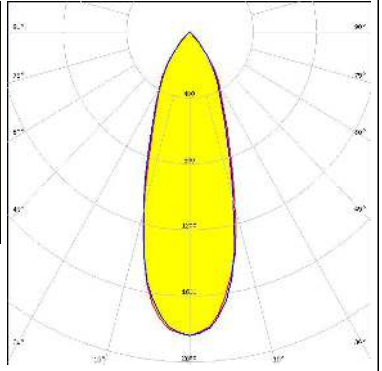
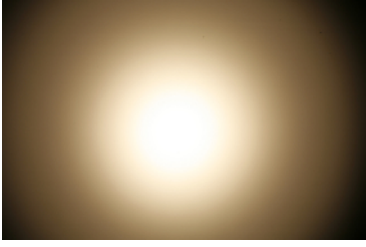
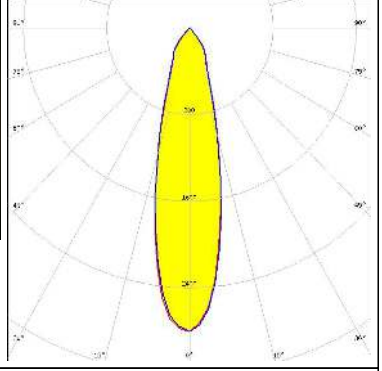
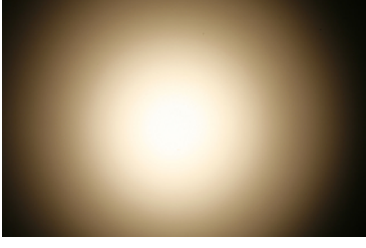
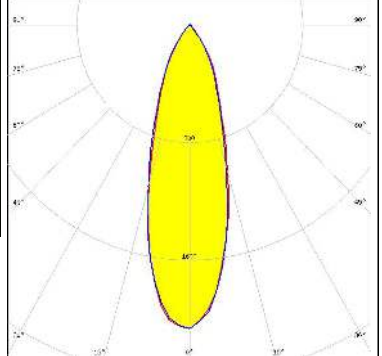
<p><b>OSRAM</b> Opto Semiconductors</p> <p>LED Soleriq S13</p> <p>FWHM / FWTM 38.0° / 74.0°</p> <p>Efficiency 82 %</p> <p>Peak intensity 1.6 cd/lm</p> <p>LEDs/each optic 1</p> <p>Light colour White</p> <p>Required components: C13333_MIRELLA-CL</p>		
<p><b>OSRAM</b> Opto Semiconductors</p> <p>LED Soleriq S13</p> <p>FWHM / FWTM 35.0° / 76.0°</p> <p>Efficiency 87 %</p> <p>Peak intensity 1.8 cd/lm</p> <p>LEDs/each optic 1</p> <p>Light colour White</p> <p>Required components:</p>		
<p><b>SEOUL SEMICONDUCTOR</b></p> <p>LED ZC4/6</p> <p>FWHM / FWTM 26.0° / 66.0°</p> <p>Efficiency 87 %</p> <p>Peak intensity 2.8 cd/lm</p> <p>LEDs/each optic 1</p> <p>Light colour White</p> <p>Required components:</p>		
<p><b>SEOUL SEMICONDUCTOR</b></p> <p>LED ZC4/6</p> <p>FWHM / FWTM 32.0° / 70.0°</p> <p>Efficiency 83 %</p> <p>Peak intensity 2.1 cd/lm</p> <p>LEDs/each optic 1</p> <p>Light colour White</p> <p>Required components: C12479_MIRELLA-DL</p>		

#### OPTICAL RESULTS (MEASURED):

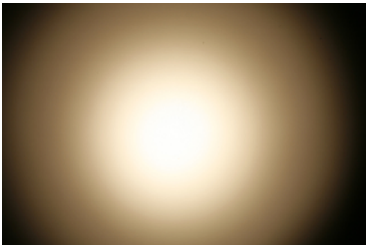
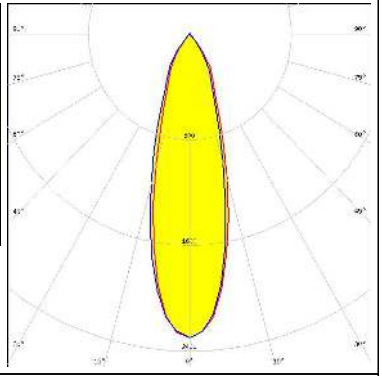
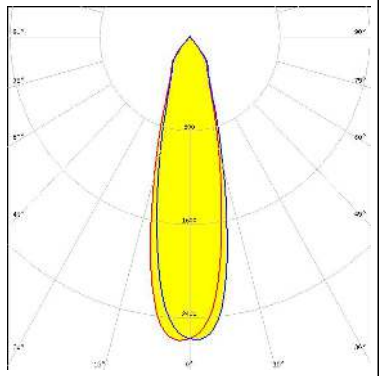
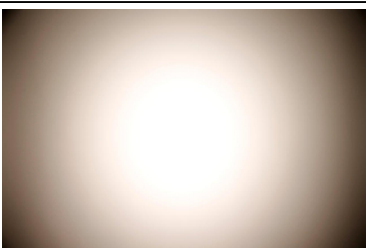
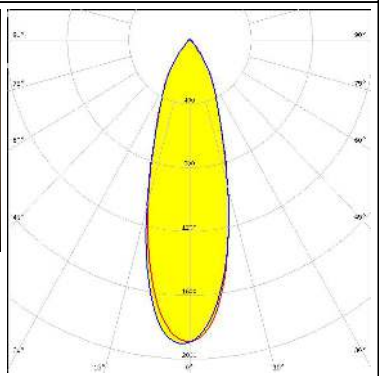
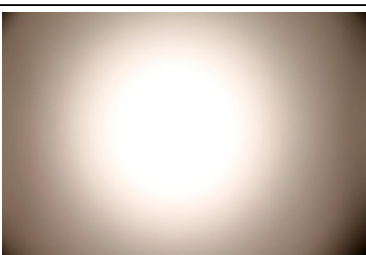
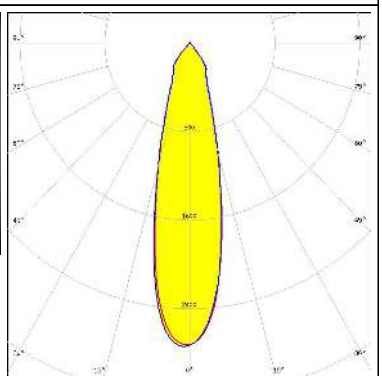
<p> <b>SEOUL SEMICONDUCTOR</b></p> <p>LED ZC4/6            FWHM / FWTM 30.0° / 69.0°            Efficiency 82 %            Peak intensity 2.3 cd/lm            LEDs/each optic 1            Light colour White            Required components:            C13333_MIRELLA-CL</p>		
<p><b>SHARP</b></p> <p>LED Mini Zenigata (GW5BM)            FWHM / FWTM 29.0° / 71.0°            Efficiency 90 %            Peak intensity 2.7 cd/lm            LEDs/each optic 1            Light colour White            Required components:</p>		
<p><b>SHARP</b></p> <p>LED Mini Zenigata (GW6BM)            FWHM / FWTM 30.0° / 70.0°            Efficiency 83 %            Peak intensity 1.9 cd/lm            LEDs/each optic 1            Light colour White            Required components:            C12479_MIRELLA-DL</p>		
<p><b>SHARP</b></p> <p>LED Mini Zenigata (GW6BM)            FWHM / FWTM 25.0° / 73.0°            Efficiency 90 %            Peak intensity 2.7 cd/lm            LEDs/each optic 1            Light colour White            Required components:</p>		

#### OPTICAL RESULTS (SIMULATED):

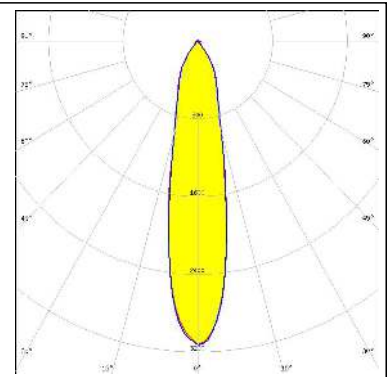
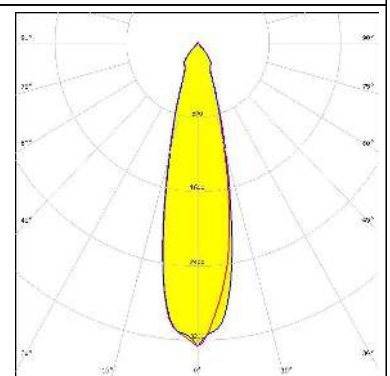
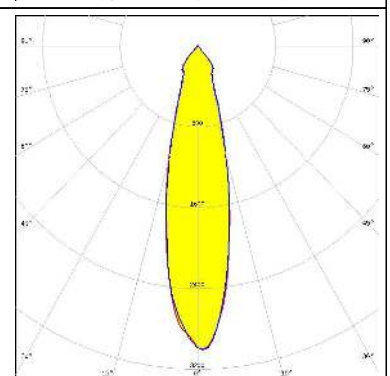
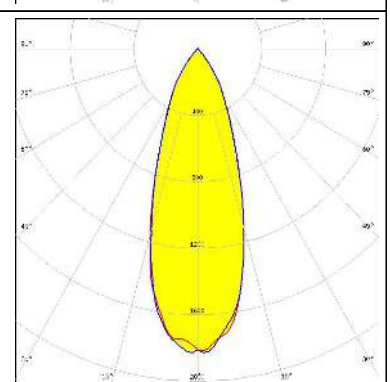
<p><b>bridgelux</b></p> <p>LED: Vero SE 10            FWHM / FWTM: 22.0° / 64.0°            Efficiency: 91 %            Peak intensity: 3.1 cd/lm            LEDs/each optic: 1            Light colour: White            Required components:</p>	
<p><b>LUMILEDS</b></p> <p>LED: LUXEON 7070            FWHM / FWTM: 26.0° / 52.0°            Efficiency: 96 %            Peak intensity: 3.3 cd/lm            LEDs/each optic: 1            Light colour: White            Required components:</p>	
<p><b>OSRAM</b>  <small>Opto Semiconductors</small></p> <p>LED: OSCONIQ P 7070            FWHM / FWTM: 25.0° / 59.0°            Efficiency: 91 %            Peak intensity: 3 cd/lm            LEDs/each optic: 1            Light colour: White            Required components:</p>	
<p><b>OSRAM</b>  <small>Opto Semiconductors</small></p> <p>LED: Soleriq S9            FWHM / FWTM: 35.0° / 71.0°            Efficiency: 85 %            Peak intensity: 1.9 cd/lm            LEDs/each optic: 1            Light colour: White            Required components:            C12479_MIRELLA-DL</p>	

#### OPTICAL RESULTS (SIMULATED):

<p><b>OSRAM</b> Opto Semiconductors</p> <p>LED: Soleriq S9</p> <p>FWHM / FWTM: 34.0° / 71.0°</p> <p>Efficiency: 87 %</p> <p>Peak intensity: 2 cd/lm</p> <p>LEDs/each optic: 1</p> <p>Light colour: White</p> <p>Required components: C13333_MIRELLA-CL</p>	
<p><b>OSRAM</b> Opto Semiconductors</p> <p>LED: Soleriq S9</p> <p>FWHM / FWTM: 31.0° / 73.0°</p> <p>Efficiency: 91 %</p> <p>Peak intensity: 2.3 cd/lm</p> <p>LEDs/each optic: 1</p> <p>Light colour: White</p> <p>Required components:</p>	

### GENERAL INFORMATION:

NOTE: The typical beam angle will be changed by different color, chip size and chip position tolerance. The typical total beam angle is the full angle measured where the luminous intensity is half of the peak value.

Due to use of high power COB's with this product, special attention to proper thermal design is highly recommended. LEDiL has no liability for direct, indirect or consecutive damages arising from the LEDiL products being used outside of the recommended temperature range.

### MATERIALS:

As part of our continuous research and improvement processes, and to ensure the best possible quality and availability of our products, LEDiL reserves the right to change material grades without notice.

### PRODUCT DATA USER AGREEMENT AND DISCLAIMER:

The measured data in the provided downloadable LEDiL Product Datasheets and Mechanical 2D-Drawings is rounded and provided as reference for planning. LEDiL Oy's optical specifications have been verified by conducting performance testing of the products in accordance with the company's quality system. The reported data are averaged results of multiple measurements with typical variation. LEDiL Oy reserves the right to without prior notification make changes and improvements to its products.

LEDiL Oy assumes neither warranty, nor guarantee nor any other liability of any kind for the contents and correctness of the provided data. The provided data has been generated with highest diligence but the provided data may in reality not represent the complete possible variation range of all intrinsic parameters. Therefore, in certain cases a deviation from the provided data could occur.

LEDiL Oy reserves the right to undertake technical changes of its products without further notification which could lead to changes in the provided data. LEDiL Oy assumes no liability of any kind for the possible deviation from any provided data or any other damage resulting from the usage of the provided data.

The user agrees to this disclaimer and user agreement with the download or usage of the provided files.

#### LEDiL Oy

Joensuunkatu 13  
FI-24240 SALO  
Finland

#### LEDiL Inc.

228 West Page Street  
Suite D  
Sycamore IL 60178  
USA

#### Ledil Optics Technology (Shenzhen) Co., Ltd.

# 405 , Block B  
Casic Motor Building  
Shenzhen 518057  
P.R.CHINA

#### Local sales and technical support

[www.ledil.com/  
where\\_to\\_buy](http://www.ledil.com/where_to_buy)

#### Shipping locations

Salo, Finland  
Hong Kong, China

#### Distribution Partners

[www.ledil.com/  
where\\_to\\_buy](http://www.ledil.com/where_to_buy)