

THIS DOCUMENT AND THE DATA DISCLOSED HEREIN OR HEREWITH IS NOT TO BE REPRODUCED, USED, OR DISCLOSED IN WHOLE OR IN PART TO ANYONE WITHOUT PERMISSION OF VICOR CORP.

REV.	DESCRIPTION	DATE	APPRO
1	RELEASED PER E100198	JS 02/26/10	REJH

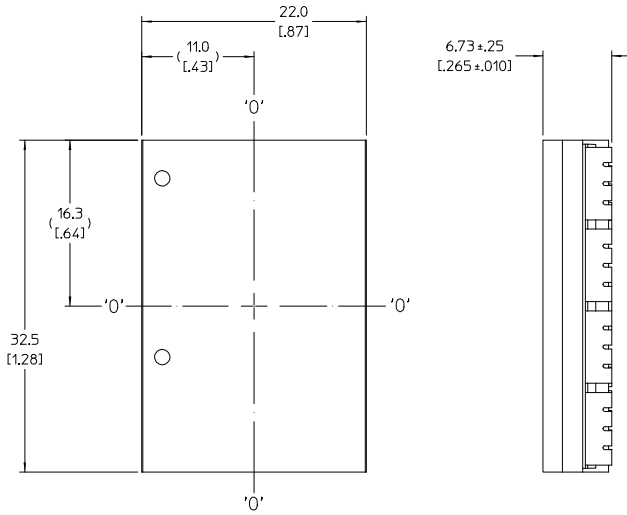

TOP VIEW (COMPONENT SIDE SHOWN)

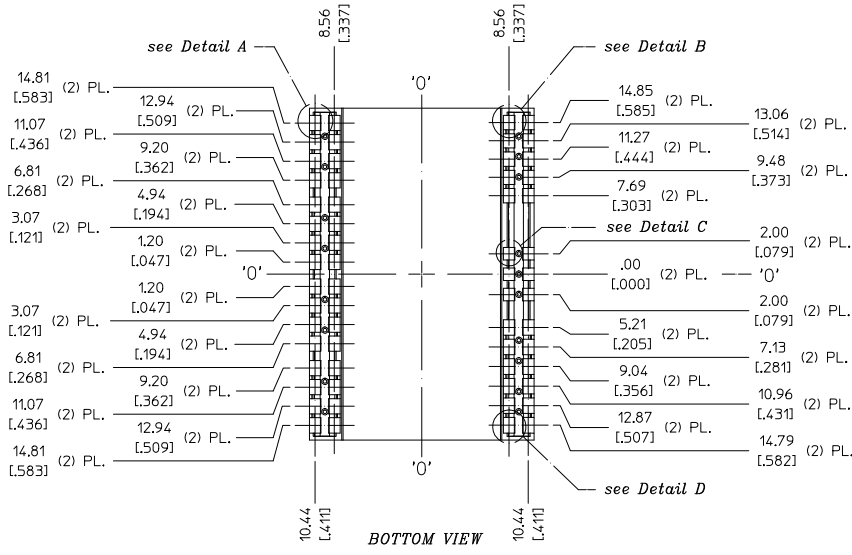
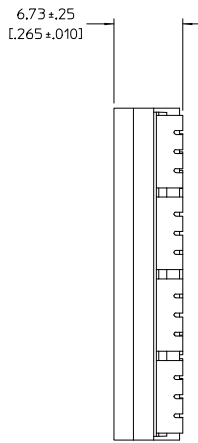

BOTTOM VIEW

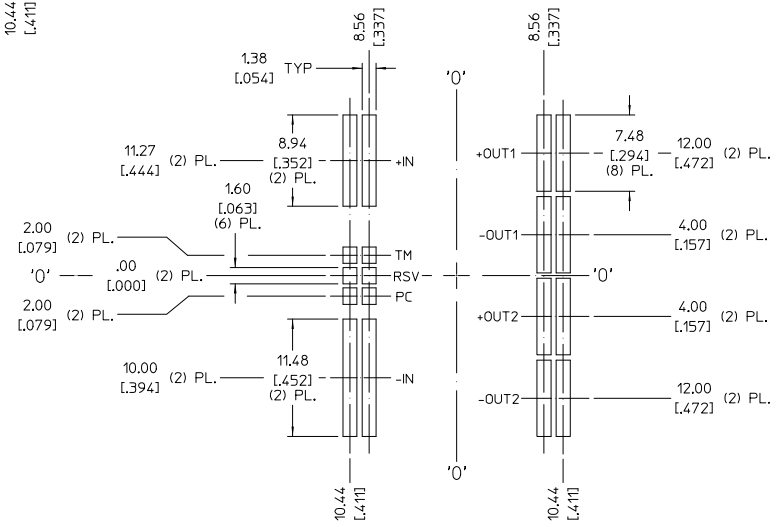
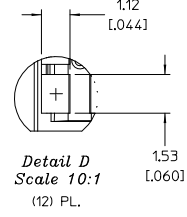
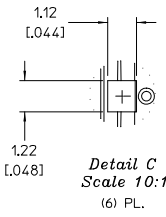
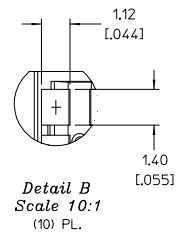
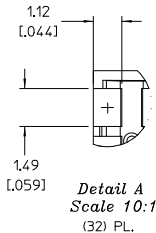
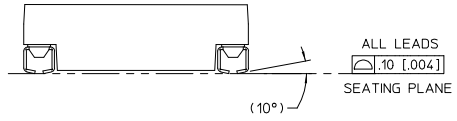

RECOMMENDED LAND PATTERN (COMPONENT SIDE SHOWN)

NOTE:
1. RoHS COMPLIANT PER CST-0001 LATEST REVISION.

DRAWN BY R.L.J. JENSEN	DATE 11/17/09	VICOR	
UNLESS OTHERWISE SPECIFIED DIMENSIONS ARE IN INCHES DECIMALS AND ANGLES IN DEGREES		PRODUCT OUTLINE DWG BCM W/J-LEADS PKG3	
THIRD ANGLE PROJECTION	SCALE 4:1	CAGE CODE 67131	DWG NO 36058
DO NOT SCALE DRAWING	SCALE	SHEET 1	OF 1