

XS1M30MA250K

Inductive proximity sensors XS, inductive sensor XS1 M30, L72mm, brass, Sn10mm, 24...240VAC/DC, 1/2"



Main

Range of Product	Telemecanique Inductive proximity sensors XS
Series name	General purpose
Sensor Type	Inductive proximity sensor
Wiring configuration	2-wire
Output circuit type	AC/DC
Protection type	Short-circuit protection multi voltage
Device Application	2-wire DC short-circuit protection
Sensor name	XS1
Sensor design	Cylindrical M30
Size	72 mm
Body type	Fixed
Detector flush mounting acceptance	Flush mountable
Material	Metal
Type of output signal	Discrete
Wiring Technique	2-wire
[Sn] nominal sensing distance	0.39 in (10 mm)
Discrete output function	1 NO
Electrical connection	Male connector 1/2"20 UNF, 3 pins
[Us] rated supply voltage	24...210 V DC 24...240 V AC 50/60 Hz
Switching capacity in mA	5...300 mA AC overload and short-circuit protection 5...200 mA DC overload and short-circuit protection
IP degree of protection	IP67 conforming to IEC 60529

Complementary

Thread type	M30 x 1.5
Detection face	Frontal
Front material	PPS
Enclosure Material	Nickel Plated Brass
Operating zone	0.00...0.31 in (0...8 mm)
Differential travel	1...15% of Sr
Status LED	Output state 1 LED yellow) Supply on 1 LED green)
Supply voltage limits	20...264 V AC/DC
Maximum residual current	1.5 mA open state
Switching frequency	<= 2000 Hz DC <= 25 Hz AC
Maximum voltage drop	<5.5 V closed state)
Maximum delay first up	70 ms
Maximum delay response	2 ms
Maximum delay recovery	5 ms
Marking	CE
Threaded length	2.01 in (51 mm)
Length	2.83 in (72 mm)
Net Weight	0.32 lb(US) (0.145 kg)

Environment

Product Certifications	CSA UL CCC
Ambient air temperature for operation	-13...158 °F (-25...70 °C)
Ambient Air Temperature for Storage	-40...185 °F (-40...85 °C)
Vibration resistance	25 gn +/- 2 mm 10...55 Hz)IEC 60068-2-6
Shock resistance	50 gn 11 ms IEC 60068-2-7





Ordering and shipping details

Category	22486 - SENSORS, PROXIMITY
Discount Schedule	DS2
GTIN	3389110916058
Nbr. of units in pkg.	1
Package weight(Lbs)	5.36 oz (152 g)
Returnability	Yes
Country of origin	FR

Packing Units

Unit Type of Package 1	PCE
Package 1 Height	1.65 in (4.2 cm)
Package 1 width	2.99 in (7.6 cm)
Package 1 Length	4.69 in (11.9 cm)
Unit Type of Package 2	S01
Number of Units in Package 2	12
Package 2 Weight	4.76 lb(US) (2.16 kg)
Package 2 Height	5.91 in (15 cm)
Package 2 width	5.91 in (15 cm)
Package 2 Length	15.75 in (40 cm)
Package 3 Height	5.91 in (15 cm)

Offer Sustainability

Sustainable offer status	Green Premium product
California proposition 65	WARNING: This product can expose you to chemicals including: Diisononyl phthalate (DINP), which is known to the State of California to cause cancer, and Di-isodecyl phthalate (DIDP), which is known to the State of California to cause birth defects or other reproductive harm. For more information go to www.P65Warnings.ca.gov
REACH Regulation	 REACH Declaration
EU RoHS Directive	Pro-active compliance (Product out of EU RoHS legal scope)  EU RoHS Declaration
Mercury free	Yes
RoHS exemption information	 Yes
Environmental Disclosure	 Product Environmental Profile
Circularity Profile	 End Of Life Information

Contractual warranty

Warranty	18 months
----------	-----------

Dimensions

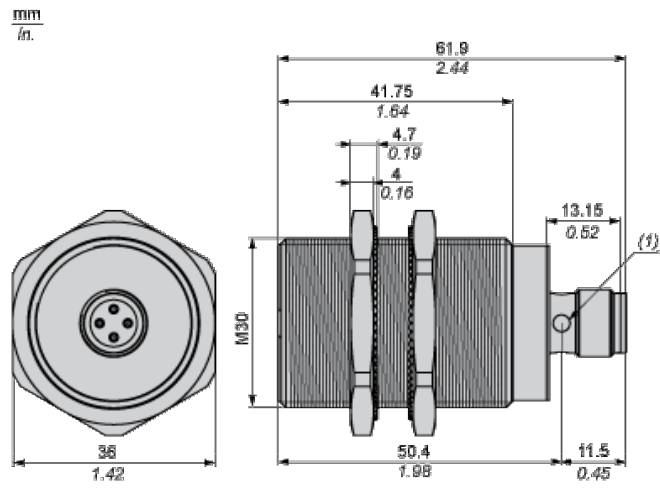

(1) LED

Minimum Mounting Distances

Side by side

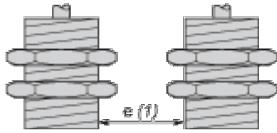

e (1) 20 mm/0.79 in

≥

Face to face

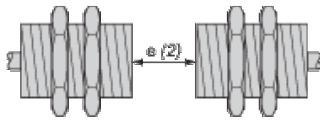

e (2) 120 mm/4.72 in

≥

Facing a metal object

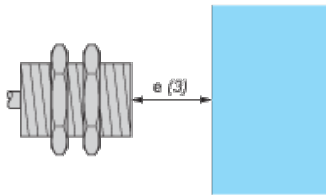

e (3) 30 mm/1.18 in.

≥

Wiring Schemes

1/2"-20UNF

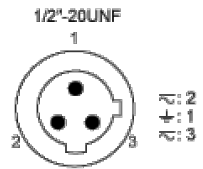

1 : Grounding

2 : AC

3 : AC

NO output

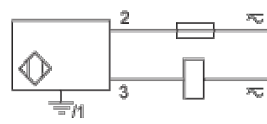

Performance Curves

Standard Steel Target : 30x30x1 mm

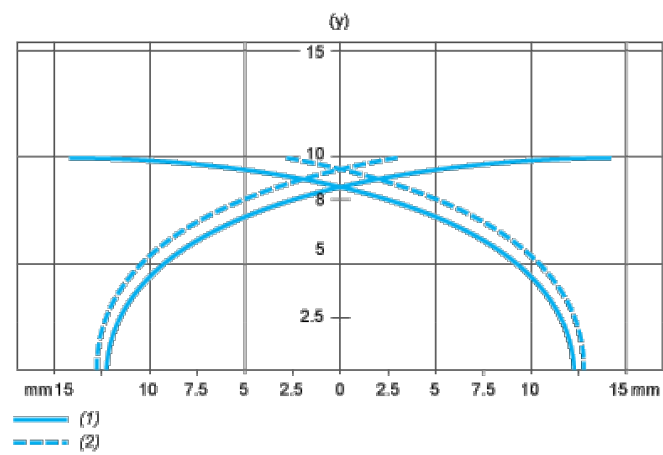

- (1) Pick-up points
- (2) Drop-out points (object approaching from the side)
- (y) Sensing distance in mm