

FLORENTINA-1-MRK-M

~40° medium beam. Compatible with ultra high power LEDs.

SPECIFICATION:

Dimensions	39.7 x 39.7 mm
Height	13 mm
Fastening	pin
ROHS compliant	yes ⓘ

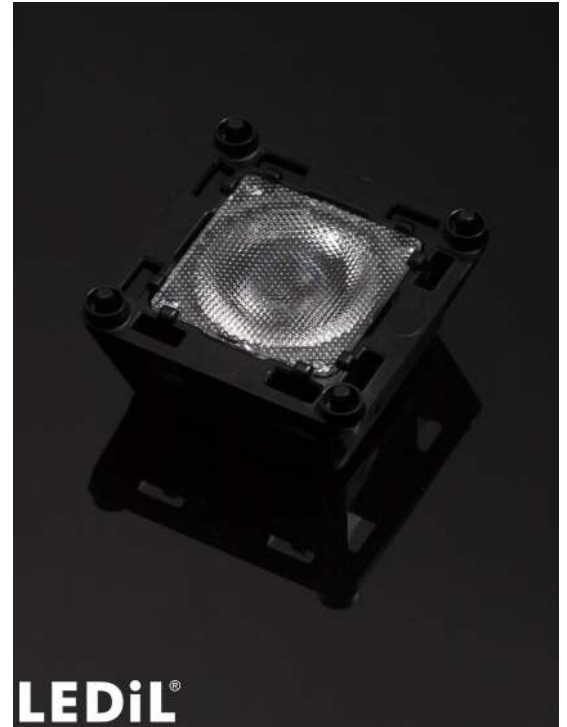

MATERIALS:

Component	Type	Material	Colour	Finish
ROSE-MRK-M	Single lens	PC	clear	
FLORENTINA-1-HLD	Holder	PC	black	
ROSE-TAPE	Tape	Acrylic foam	black	

ORDERING INFORMATION:

Component		Qty in box	MOQ	MPQ	Box weight (kg)
FCA15512_FLORENTINA-1-MRK-M	Single lens	840		60	7.7
» Box size: 480 x 280 x 300 mm					

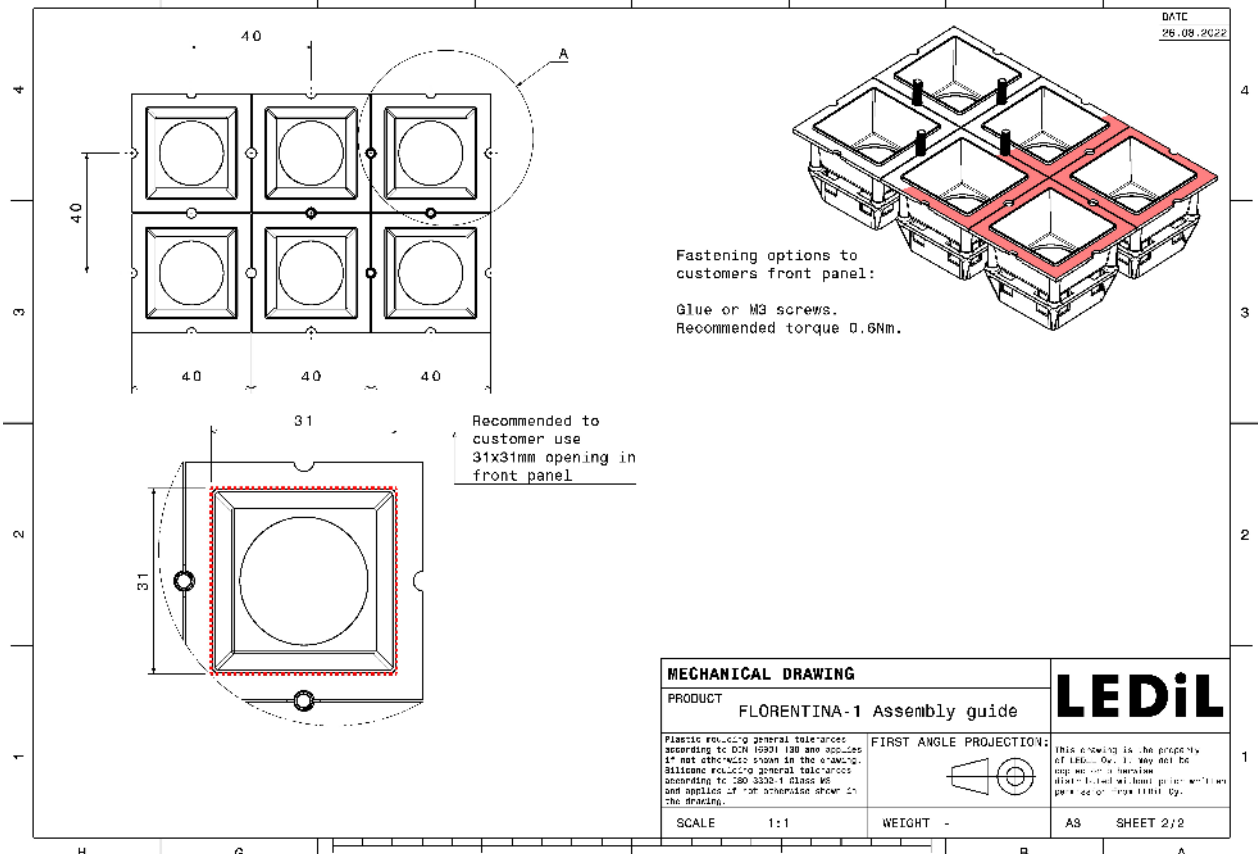
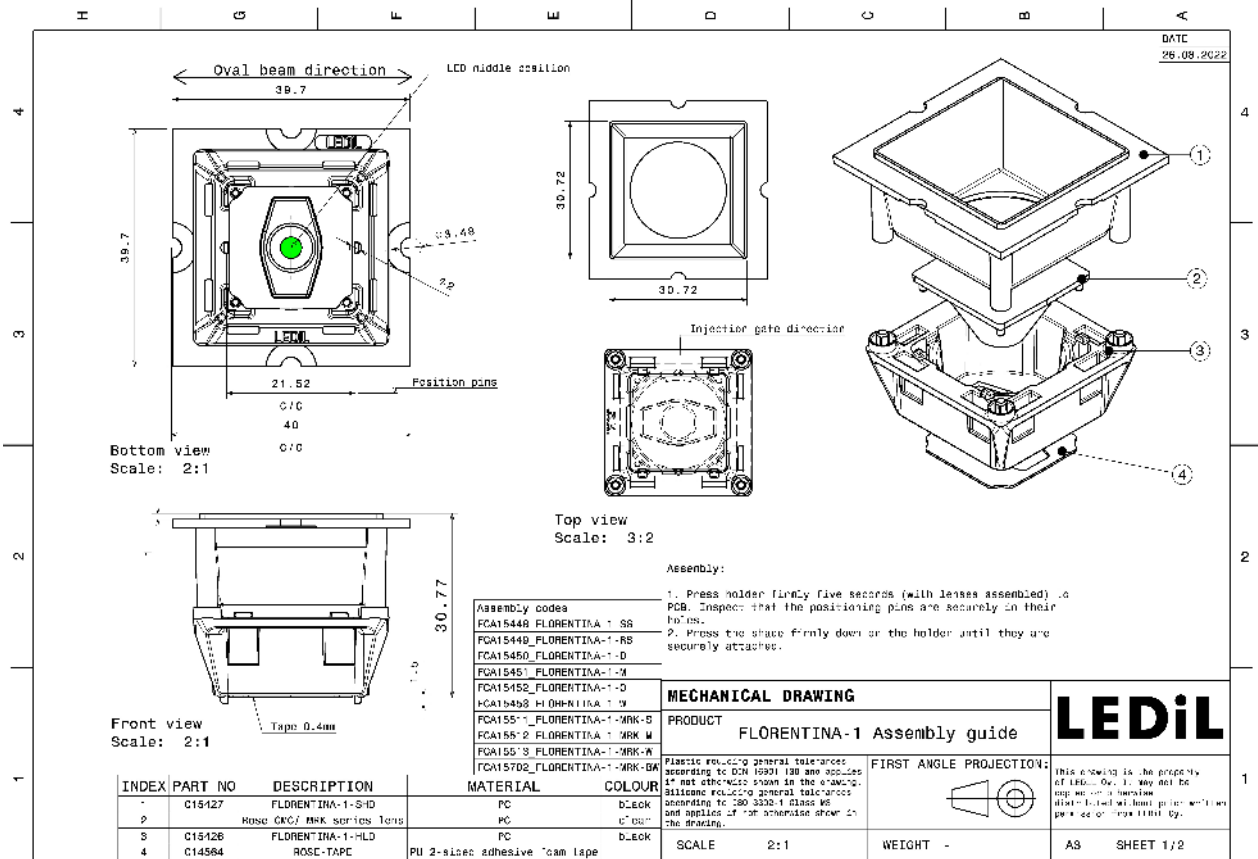





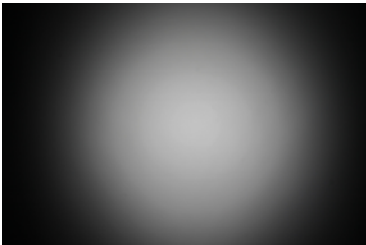
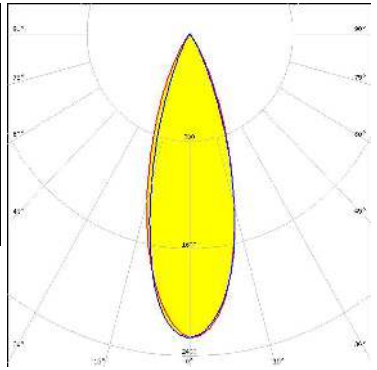
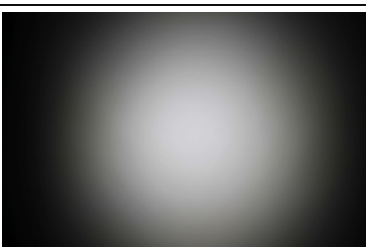
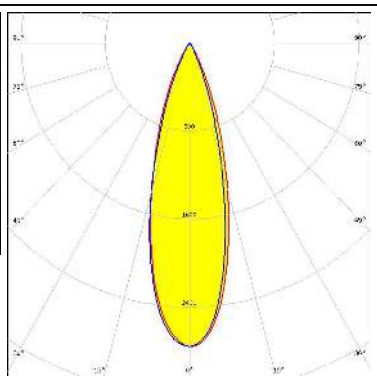
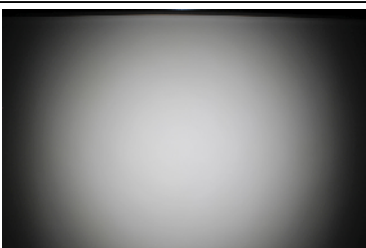
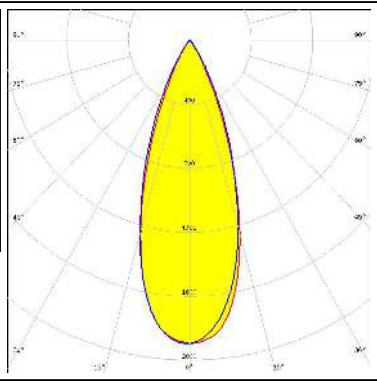
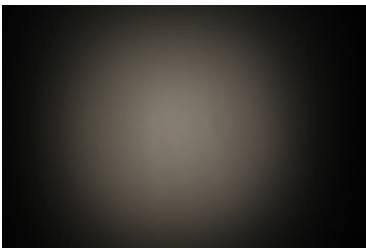
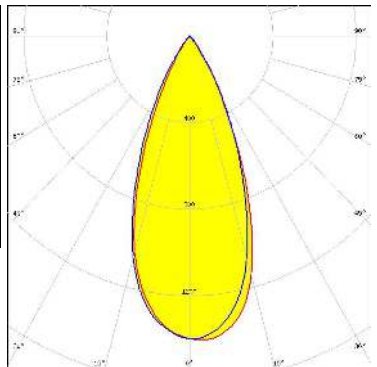

See also our general installation guide: www.ledil.com/installation_guide

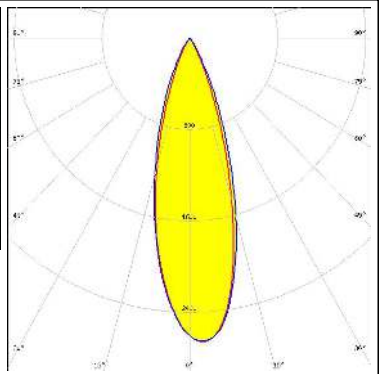

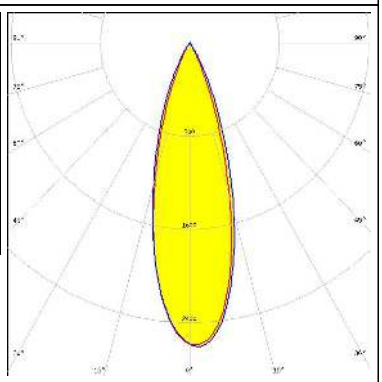

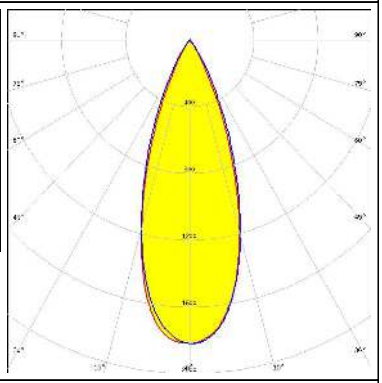
OPTICAL RESULTS (MEASURED):

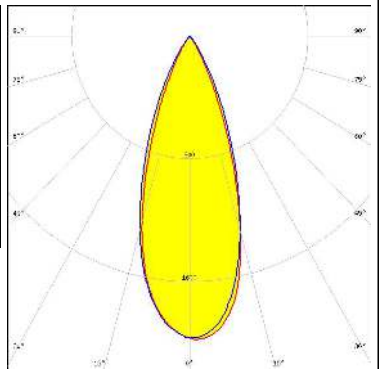
<p>CREE LED</p> <p>LED XHP35 HI FWHM / FWTM 33.0° / 57.0° Efficiency 77 % Peak intensity 2.3 cd/m LEDs/each optic 1 Light colour White Required components: C15427_FLORENTINA-1-SHD-60</p>		
<p>LUMILEDS</p> <p>LED LUXEON 3030 2D (Round LES) FWHM / FWTM 29.0° / 53.0° Efficiency 79 % Peak intensity 2.8 cd/m LEDs/each optic 1 Light colour White Required components:</p>		
<p>LUMILEDS</p> <p>LED LUXEON 5050 Round LES FWHM / FWTM 37.0° / 61.0° Efficiency 78 % Peak intensity 1.9 cd/m LEDs/each optic 1 Light colour White Required components: C15427_FLORENTINA-1-SHD-60</p>		
<p>LUMILEDS</p> <p>LED LUXEON M/MX FWHM / FWTM 42.0° / 65.0° Efficiency 75 % Peak intensity 1.4 cd/m LEDs/each optic 1 Light colour White Required components: C15427_FLORENTINA-1-SHD-60</p>		

OPTICAL RESULTS (MEASURED):

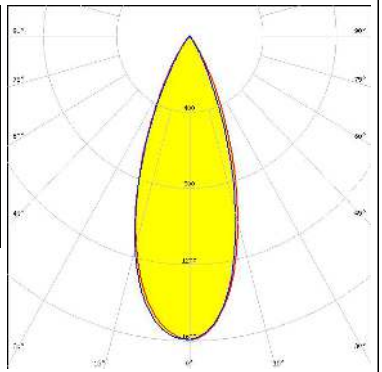
<p>NICHIA</p> <p>LED NF2x757G FWHM / FWTM 30.0° / 54.0° Efficiency 81 % Peak intensity 2.7 cd/lm LEDs/each optic 1 Light colour White Required components: C15427_FLORENTINA-1-SHD-60</p>		
<p>NICHIA</p> <p>LED NF2x757G FWHM / FWTM 31.0° / 54.0° Efficiency 80 % Peak intensity 2.6 cd/lm LEDs/each optic 1 Light colour White Required components: C16701_FLORENTINA-1-SHD-60-WHT</p>		
<p>NICHIA</p> <p>LED NFMW48xA FWHM / FWTM 37.0° / 61.0° Efficiency 75 % Peak intensity 1.8 cd/lm LEDs/each optic 1 Light colour White Required components: C15427_FLORENTINA-1-SHD-60</p>		
<p>NICHIA</p> <p>LED NVSW319B FWHM / FWTM 21.0° / 40.0° Efficiency 75 % Peak intensity 4.5 cd/lm LEDs/each optic 1 Light colour White Required components: C15427_FLORENTINA-1-SHD-60</p>		

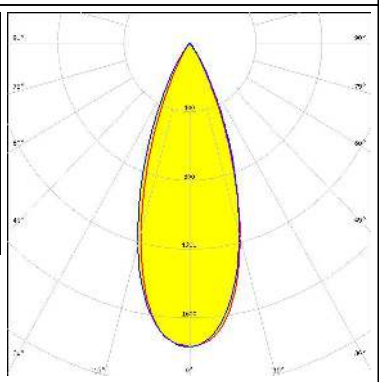
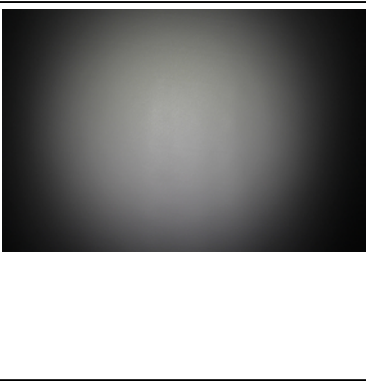
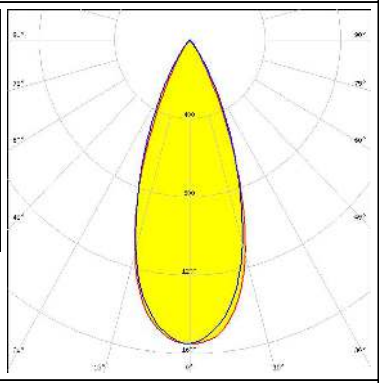
OPTICAL RESULTS (MEASURED):

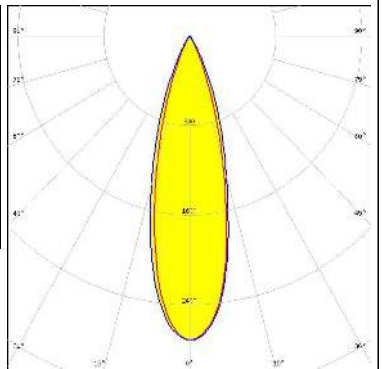
<p>OSRAM Opto Semiconductors</p> <p>LED Duris S10</p> <p>FWHM / FWTM 38.0° / 62.0°</p> <p>Efficiency 70 %</p> <p>Peak intensity 1.6 cd/m</p> <p>LEDs/each optic 1</p> <p>Light colour White</p> <p>Required components: C15427_FLORENTINA-1-SHD-60</p>		
<p>OSRAM Opto Semiconductors</p> <p>LED Duris S8</p> <p>FWHM / FWTM 38.0° / 61.0°</p> <p>Efficiency 75 %</p> <p>Peak intensity 1.8 cd/m</p> <p>LEDs/each optic 1</p> <p>Light colour White</p> <p>Required components: C15427_FLORENTINA-1-SHD-60</p>		
<p>OSRAM Opto Semiconductors</p> <p>LED OSCONIQ P 7070</p> <p>FWHM / FWTM 40.0° / 62.0°</p> <p>Efficiency 74 %</p> <p>Peak intensity 1.6 cd/m</p> <p>LEDs/each optic 1</p> <p>Light colour White</p> <p>Required components: C15427_FLORENTINA-1-SHD-60</p>		
<p>OSRAM Opto Semiconductors</p> <p>LED OSLON SSL 150</p> <p>FWHM / FWTM 27.0° / 49.0°</p> <p>Efficiency 76 %</p> <p>Peak intensity 2.7 cd/m</p> <p>LEDs/each optic 1</p> <p>Light colour White</p> <p>Required components: C15427_FLORENTINA-1-SHD-60</p>		

OPTICAL RESULTS (MEASURED):

SAMSUNG

LED LM561B
FWHM / FWTM 31.0° / 55.0°
Efficiency 80 %
Peak intensity 2.6 cd/lm
LEDs/each optic 1
Light colour White
Required components:
C15427_FLORENTINA-1-SHD-60

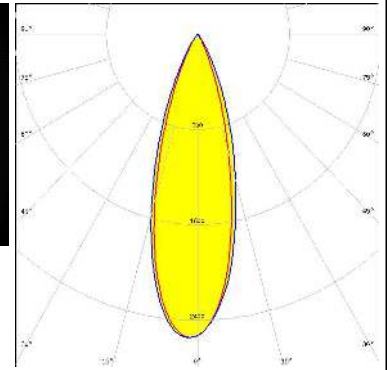
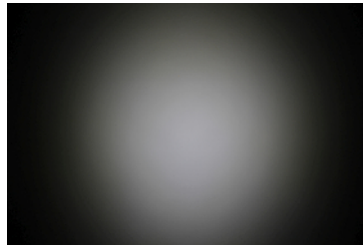

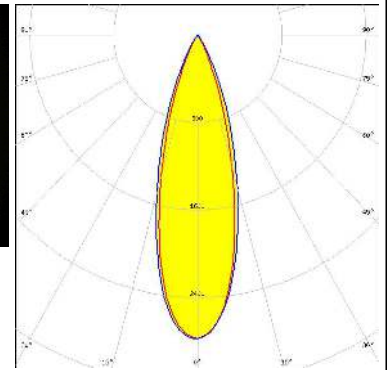
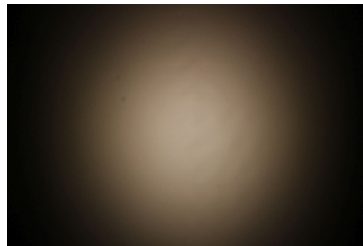

SEOUL SEMICONDUCTOR
LED SEOUL 5630
FWHM / FWTM 30.0° / 54.0°
Efficiency 83 %
Peak intensity 2.8 cd/lm
LEDs/each optic 1
Light colour White
Required components:
C15427_FLORENTINA-1-SHD-60



OPTICAL RESULTS (SIMULATED):

SAMSUNG

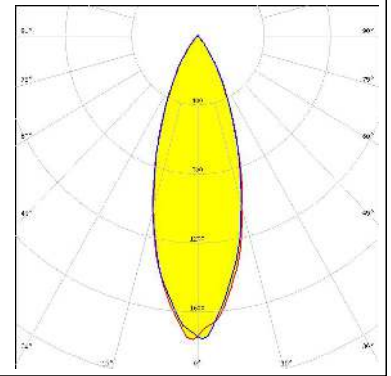
LED	LH351B
FWHM / FWTM	35.0° / 68.0°
Efficiency	77 %
Peak intensity	1.8 cd/lm
LEDs/each optic	1
Light colour	White
Required components:	
	C15427_FLORENTINA-1-SHD-60



GENERAL INFORMATION:

NOTE: The typical beam angle will be changed by different color, chip size and chip position tolerance. The typical total beam angle is the full angle measured where the luminous intensity is half of the peak value.

MATERIALS:

As part of our continuous research and improvement processes, and to ensure the best possible quality and availability of our products, LEDiL reserves the right to change material grades without notice.

PRODUCT DATA USER AGREEMENT AND DISCLAIMER:

The measured data in the provided downloadable LEDiL Product Datasheets and Mechanical 2D-Drawings is rounded and provided as reference for planning. LEDiL Oy's optical specifications have been verified by conducting performance testing of the products in accordance with the company's quality system. The reported data are averaged results of multiple measurements with typical variation. LEDiL Oy reserves the right to without prior notification make changes and improvements to its products.

LEDiL Oy assumes neither warranty, nor guarantee nor any other liability of any kind for the contents and correctness of the provided data. The provided data has been generated with highest diligence but the provided data may in reality not represent the complete possible variation range of all intrinsic parameters. Therefore, in certain cases a deviation from the provided data could occur.

LEDiL Oy reserves the right to undertake technical changes of its products without further notification which could lead to changes in the provided data. LEDiL Oy assumes no liability of any kind for the possible deviation from any provided data or any other damage resulting from the usage of the provided data.

The user agrees to this disclaimer and user agreement with the download or usage of the provided files.

LEDiL Oy

Joensuunkatu 13
FI-24240 SALO
Finland

LEDiL Inc.

228 West Page Street
Suite D
Sycamore IL 60178
USA

Ledil Optics Technology (Shenzhen) Co., Ltd.

405 , Block B
Casic Motor Building
Shenzhen 518057
P.R.CHINA

Local sales and technical support

[www.ledil.com/
where_to_buy](http://www.ledil.com/where_to_buy)

Shipping locations

Salo, Finland
Hong Kong, China

Distribution Partners

[www.ledil.com/
where_to_buy](http://www.ledil.com/where_to_buy)