

## LSF-SMD 3.50/10/135 SN BK RL

**Weidmüller Interface GmbH & Co. KG**

Klingenbergstraße 26

D-32758 Detmold

Germany

www.weidmueller.com

### Product image

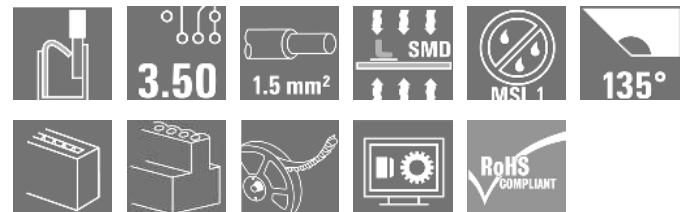

### The innovative quick connector - simple, safe and economical:

PCB terminals with spring connection and direct PUSH IN technology. A milestone in connection technology.

Amazingly simple and simply amazing in practice:

- Connect and easily detach solid wires or wires with wire-end ferrules without using tools
- Processed automatically in the reflow or vapour phase
- Potentials and clamping points marked clearly by coloured push buttons

World-class design-in and processing phases, and suitable for a vast range of applications.

**PCB terminal for fully automatic assembly using reflow soldering (SMD), with PUSH IN wire connections. Conductor insertion and slider operation from the same direction (TOP).**

- **Solid & flexible conductors with wire-end ferrules need only to be inserted and they are ready.**
- **When connecting stranded wires without wire-end ferrules the actuating element is used to open the terminal point**
- **Intuitive handling – since the wire-entry area and handling area are clearly separated.**
- **Packaged in tape-on-reel**
- **Conductor outlet direction 135°**

### General ordering data

Version	Printed circuit board terminals, 3.50 mm, Number of poles: 10, 135°, black, PUSH IN with actuator, Clamping range, max.: 1.5 mm², Tape
Order No.	<a href="#">1473410000</a>
Type	LSF-SMD 3.50/10/135 SN BK RL
GTIN (EAN)	4050118279672
Qty.	210 pc(s).
Product data	IEC: 320 V / 12 A / 0.2 - 1.5 mm² UL: 300 V / 12 A / AWG 28 - AWG 14
Packaging	Tape

## LSF-SMD 3.50/10/135 SN BK RL

**Weidmüller Interface GmbH & Co. KG**

Klingenbergstraße 26

D-32758 Detmold

Germany

www.weidmueller.com

## Technical data

### Dimensions and weights

Depth	12.7 mm	Depth (inches)	0.5 inch
Height	14.45 mm	Height (inches)	0.569 inch
Height of lowest version	14.45 mm	Width	35.7 mm
Width (inches)	1.406 inch	Net weight	8.538 g

### Temperatures

Operating temperature, min.	-50 °C	Operating temperature, max.	120 °C
Continuous operating temp., max.	120 °C		

### System parameters

Product family	OMNIMATE Signal - series LSF	Wire connection method	PUSH IN with actuator
Mounting onto the PCB	SMD solder connection	Conductor outlet direction	135°
Pitch in mm (P)	3.5 mm	Pitch in inches (P)	0.138 inch
Number of poles	10	Pin series quantity	1
Fitted by customer	No	Number of rows	1
Coplanarity:	100 µm	Number of solder pins per pole	2
Stripping length	8 mm	L1 in mm	31.5 mm
L1 in inches	1.242 inch	Touch-safe protection acc. to DIN VDE 0470	IP 20
Touch-safe protection acc. to DIN VDE 57 106	Safe from finger touch	Protection degree	IP20
Volume resistance	1.60 mΩ		

### Material data

Insulating material	LCP GF	Colour	black
Colour chart (similar)	RAL 9011	Insulating material group	IIIa
Comparative Tracking Index (CTI)	≥ 175	Moisture Level (MSL)	1
UL 94 flammability rating	V-0	Contact material	Copper alloy
Layer structure of solder connection	4...6 µm Sn matt	Storage temperature, min.	-40 °C
Storage temperature, max.	70 °C	Operating temperature, min.	-50 °C
Operating temperature, max.	120 °C	Temperature range, installation, min.	-30 °C
Temperature range, installation, max.	120 °C		

### Conductors suitable for connection

Clamping range, min.	0.13 mm <sup>2</sup>
Clamping range, max.	1.5 mm <sup>2</sup>
Wire connection cross section AWG, min.	AWG 28
Wire connection cross section AWG, max.	AWG 14
Solid, min. H05(07) V-U	0.2 mm <sup>2</sup>
Solid, max. H05(07) V-U	1.5 mm <sup>2</sup>
Flexible, min. H05(07) V-K	0.2 mm <sup>2</sup>
Flexible, max. H05(07) V-K	1.5 mm <sup>2</sup>
w. plastic collar ferrule, DIN 46228 pt 4, 0.25 mm <sup>2</sup> min.	
w. plastic collar ferrule, DIN 46228 pt 4, 0.75 mm <sup>2</sup> max.	
w. wire end ferrule, DIN 46228 pt 1, 0.25 mm <sup>2</sup> min.	

Creation date August 24, 2023 8:47:39 AM CEST

**LSF-SMD 3.50/10/135 SN BK RL**

**Weidmüller Interface GmbH & Co. KG**  
 Klingenbergstraße 26  
 D-32758 Detmold  
 Germany

www.weidmueller.com

**Technical data**

w. wire end ferrule, DIN 46228 pt 1, max. 1.5 mm<sup>2</sup>

Clampable conductor	Cross-section for conductor connection	Type	fine-wired
		nominal	0.25 mm <sup>2</sup>
wire end ferrule		Stripping length	nominal 10 mm
		Recommended wire-end ferrule	<a href="#">H0.25/12 HBL</a>
Clampable conductor	Cross-section for conductor connection	Type	fine-wired
		nominal	0.34 mm <sup>2</sup>
wire end ferrule		Stripping length	nominal 10 mm
		Recommended wire-end ferrule	<a href="#">H0.34/12 TK</a>
Clampable conductor	Cross-section for conductor connection	Type	fine-wired
		nominal	0.5 mm <sup>2</sup>
wire end ferrule		Stripping length	nominal 10 mm
		Recommended wire-end ferrule	<a href="#">H0.5/14 OR</a>
Clampable conductor	Cross-section for conductor connection	Type	fine-wired
		nominal	0.75 mm <sup>2</sup>
wire end ferrule		Stripping length	nominal 10 mm
		Recommended wire-end ferrule	<a href="#">H0.75/14T HBL</a>

Reference text Length of ferrules is to be chosen depending on the product and the rated voltage.. The outside diameter of the plastic collar should not be larger than the pitch (P)

**Rated data acc. to IEC**

tested acc. to standard	IEC 60664-1, IEC 61984	Rated current, min. number of poles (Tu=20°C)	12 A
Rated current, max. number of poles (Tu=20°C)	12 A	Rated current, min. number of poles (Tu=40°C)	12 A
Rated current, max. number of poles (Tu=40°C)	12 A	Rated voltage for surge voltage class / pollution degree II/2	320 V
Rated voltage for surge voltage class / pollution degree III/2	160 V	Rated voltage for surge voltage class / pollution degree III/3	160 V
Rated impulse voltage for surge voltage class/ pollution degree II/2	2.5 kV	Rated impulse voltage for surge voltage class/ pollution degree III/2	2.5 kV
Rated impulse voltage for surge voltage class/ contamination degree III/3	2.5 kV	Short-time withstand current resistance	3 x 1s with 80 A

**Rated data acc. to CSA**

Institute (CSA)		Certificate No. (CSA)	200039-1664286
Rated voltage (Use group B / CSA)	300 V	Rated voltage (Use group D / CSA)	300 V
Rated current (Use group B / CSA)	10 A	Rated current (Use group D / CSA)	10 A
Wire cross-section, AWG, min.	AWG 28	Wire cross-section, AWG, max.	AWG 14
Reference to approval values	Specifications are maximum values, details - see approval certificate.		

## LSF-SMD 3.50/10/135 SN BK RL

**Weidmüller Interface GmbH & Co. KG**  
 Klingenbergstraße 26  
 D-32758 Detmold  
 Germany

www.weidmueller.com

## Technical data

### Rated data acc. to UL 1059

Institute (cURus)



Certificate No. (cURus)

E60693

Rated voltage (Use group B / UL 1059)	300 V	Rated voltage (Use group D / UL 1059)	300 V
Rated current (Use group B / UL 1059)	12 A	Rated current (Use group D / UL 1059)	10 A
Wire cross-section, AWG, min.	AWG 28	Wire cross-section, AWG, max.	AWG 14
Reference to approval values	Specifications are maximum values, details - see approval certificate.		

### Packing

ESD Level packaging	static dissipative	Packaging	Tape
VPE length	330 mm	VPE width	330 mm
VPE height	64 mm	Tape depth (T2)	15.7 mm
Tape width (W)	56 mm	Tape pocket depth (K0)	15.2 mm
Tape pocket height (A0)	11.3 mm	Tape pocket width (B0)	44.06 mm
Tape pocket separation (P1)	20 mm	Tape hole separation (E)	1.75 mm
Tape pocket separation (F)	26.2 mm	Tape reel diameter $\varnothing$ (A)	330 mm
Surface resistance	$R_s = 10^9 - 10^{12} \Omega$		

### Type tests

Test: Durability of markings	Test	mark of origin, type identification, pitch, approval marking UL, durability	
Test: Clampable cross section	Standard	DIN EN 60999-1 section 7 and 9.1 / 12.00, DIN EN 60947-1 section 8.2.4.5.1 / 12.02	
	Conductor type	Type of conductor and conductor cross-section	solid 0.14 mm <sup>2</sup>
		Type of conductor and conductor cross-section	stranded 0.14 mm <sup>2</sup>
		Type of conductor and conductor cross-section	solid 1.5 mm <sup>2</sup>
		Type of conductor and conductor cross-section	stranded 1.5 mm <sup>2</sup>
		Type of conductor and conductor cross-section	AWG 24/1
		Type of conductor and conductor cross-section	AWG 22/19
		Type of conductor and conductor cross-section	AWG 16/1
		Type of conductor and conductor cross-section	AWG 16/19
Evaluation	passed		

**LSF-SMD 3.50/10/135 SN BK RL**

**Weidmüller Interface GmbH & Co. KG**  
 Klingenbergstraße 26  
 D-32758 Detmold  
 Germany

www.weidmueller.com

**Technical data**

Test for damage to and accidental loosening of conductors	Standard	DIN EN 60999-1 section 9.4 / 12.00		
	Requirement	0.2 kg		
	Conductor type	Type of conductor and conductor cross-section	AWG 24/1	
		Type of conductor and conductor cross-section	AWG 24/19	
	Evaluation	passed		
	Requirement	0.3 kg		
	Conductor type	Type of conductor and conductor cross-section	stranded 0.25 mm <sup>2</sup>	
		Type of conductor and conductor cross-section	solid 0.5 mm <sup>2</sup>	
	Evaluation	passed		
	Requirement	0.4 kg		
Conductor type	Type of conductor and conductor cross-section	solid 1.5 mm <sup>2</sup>		
	Type of conductor and conductor cross-section	stranded 1.5 mm <sup>2</sup>		
	Type of conductor and conductor cross-section	AWG 16/1		
	Type of conductor and conductor cross-section	AWG 16/19		
Evaluation	passed			
Pull-out test	Standard	DIN EN 60999-1 section 9.5 / 12.00		
	Requirement	≥10 N		
	Conductor type	Type of conductor and conductor cross-section	AWG 24/1	
		Type of conductor and conductor cross-section	AWG 24/19	
	Evaluation	passed		
	Requirement	≥20 N		
	Conductor type	Type of conductor and conductor cross-section	stranded 0.25 mm <sup>2</sup>	
		Type of conductor and conductor cross-section	H05V-U0.5	
	Evaluation	passed		
	Requirement	≥40 N		
Conductor type	Type of conductor and conductor cross-section	H07V-U1.5		
	Type of conductor and conductor cross-section	H07V-K1.5		
	Type of conductor and conductor cross-section	AWG 16/1		
	Type of conductor and conductor cross-section	AWG 16/19		
Evaluation	passed			

**LSF-SMD 3.50/10/135 SN BK RL****Weidmüller Interface GmbH & Co. KG**

Klingenbergstraße 26

D-32758 Detmold

Germany

www.weidmueller.com

**Technical data****Classifications**

ETIM 6.0	EC002643	ETIM 7.0	EC002643
ETIM 8.0	EC002643	ECLASS 9.0	27-44-04-01
ECLASS 9.1	27-44-04-01	ECLASS 10.0	27-44-04-01
ECLASS 11.0	27-46-01-01	ECLASS 12.0	27-46-01-01

**Important note**

IPC conformity      Conformity: The products are developed, manufactured and delivered according international recognized standards and norms and comply with the assured properties in the data sheet resp. fulfill decorative properties in accordance with IPC-A-610 "Class 2". Further claims on the products can be evaluated on request.

- Notes
- Additional push button colours on request
  - Operating force of slider max. 40 N
  - Rated current related to rated cross-section & min. No. of poles.
  - Wire end ferrule with plastic collar to DIN 46228/4
  - Wire end ferrule without plastic collar to DIN 46228/1
  - P on drawing = pitch
  - Rated data refer only to the component itself. Clearance and creepage distances to other components are to be designed in accordance with the relevant application standards.
  - Crimping shape "A" for wire end ferrules with PZ 6/5 crimping tool recommended.
  - Long term storage of the product with average temperature of 50 °C and average humidity 70%, 36 months

**Approvals**

Approvals



ROHS	Conform
UL File Number Search	UL Website
Certificate No. (cURus)	E60693

## LSF-SMD 3.50/10/135 SN BK RL

**Weidmüller Interface GmbH & Co. KG**  
Klingenbergstraße 26  
D-32758 Detmold  
Germany

[www.weidmueller.com](http://www.weidmueller.com)

## Technical data

### Downloads

Approval/Certificate/Document of Conformity	<a href="#">Declaration of the Manufacturer</a>
Engineering Data	<a href="#">CAD data – STEP</a>
Product Change Notification	<a href="#">Changeover to ESD bags for “Tape on Reel” products</a> <a href="#">Umstellung auf ESD-Beutel bei „Tape on Reel“ Produkten</a>
Catalogues	<a href="#">Catalogues in PDF-format</a>
Brochures	<a href="#">FL DRIVES EN</a> <a href="#">PI OMNIMATE LSF SMD EN</a> <a href="#">FL ANALO.SIGN.CONV. EN</a> <a href="#">MB DEVICE MANUF. EN</a> <a href="#">FL DRIVES DE</a> <a href="#">FL BUILDING SAFETY EN</a> <a href="#">FL APPL LED LIGHTING EN</a> <a href="#">FLIndustr.CONTROLS EN</a> <a href="#">FL MACHINE SAFETY EN</a> <a href="#">FL HEATING ELECTR EN</a> <a href="#">FL APPL INVERTER EN</a> <a href="#">FL_BASE_STATION EN</a> <a href="#">FL ELEVATOR EN</a> <a href="#">FL POWER SUPPLY EN</a> <a href="#">FL 72H SAMPLE SER EN</a> <a href="#">PO OMNIMATE EN</a>
White paper surface mount technology	<a href="#">Download Whitepaper</a>

**LSF-SMD 3.50/10/135 SN BK RL**

**Weidmüller Interface GmbH & Co. KG**  
 Klingenbergstraße 26  
 D-32758 Detmold  
 Germany

www.weidmueller.com

**Drawings**

**Product image**

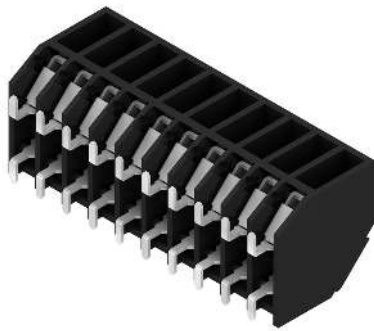

**Dimensional drawing**

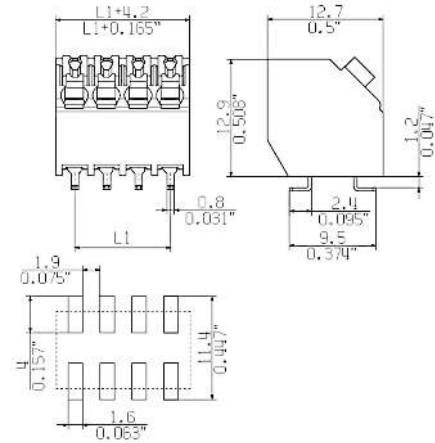

**Graph**

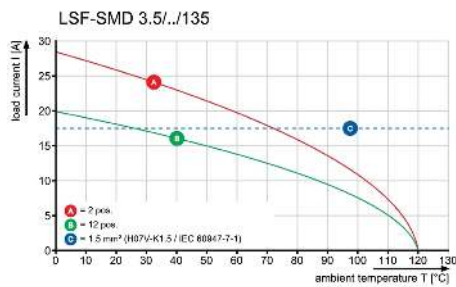

**Product benefits**

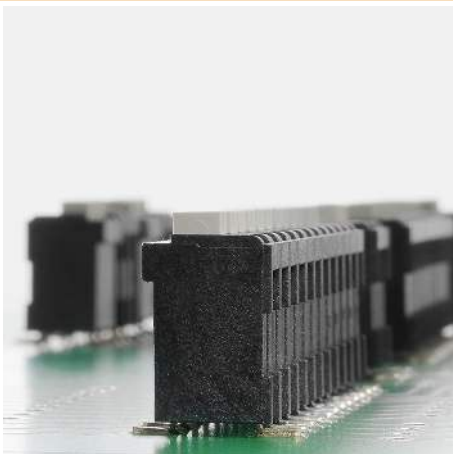

Stable solder connection

**Product benefits**

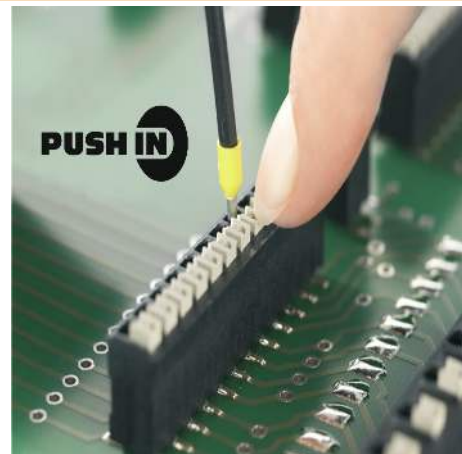

PUSH IN wire connection



**LSF-SMD 3.50/10/135 SN BK RL**

**Weidmüller Interface GmbH & Co. KG**  
 Klingenbergstraße 26  
 D-32758 Detmold  
 Germany

www.weidmueller.com

**Drawings**

**Product benefits**



Packaged in tape-on-reel

**Dimensional drawing**

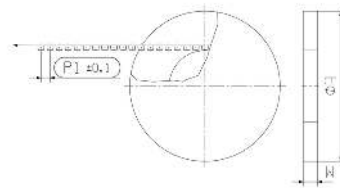

**Dimensional drawing**

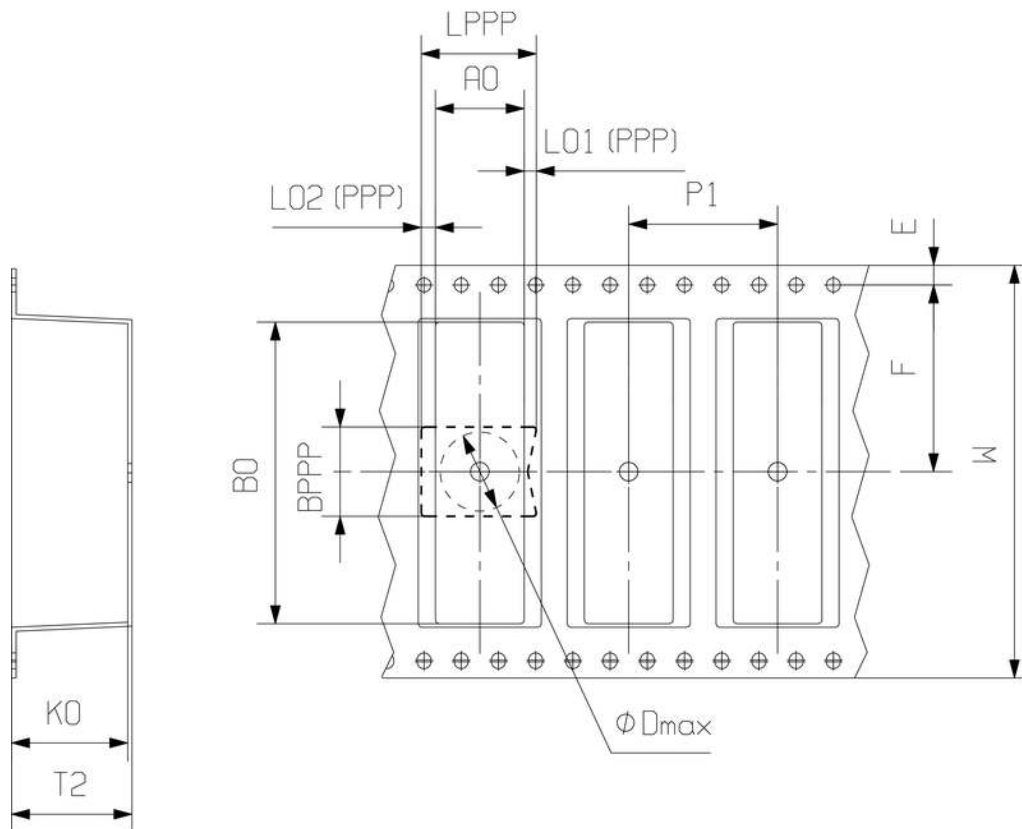

DIRECTION OF UNREELING →

MASSE OHNE TOLERANZ SIND KEINE PRUEFMASSE  
DIMS. WITHOUT TOLERANCE ARE NOT CONTROL DIMS.

DIE DEUTSCHE VERSION IST VERBINDLICH  
THE GERMAN VERSION IS BINDING

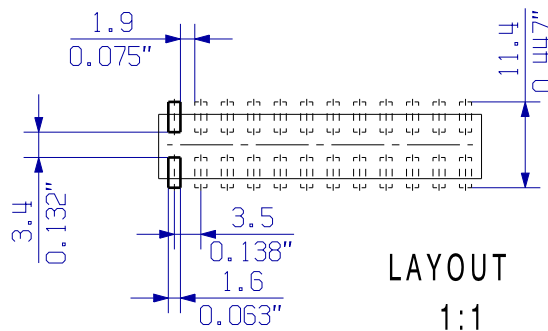
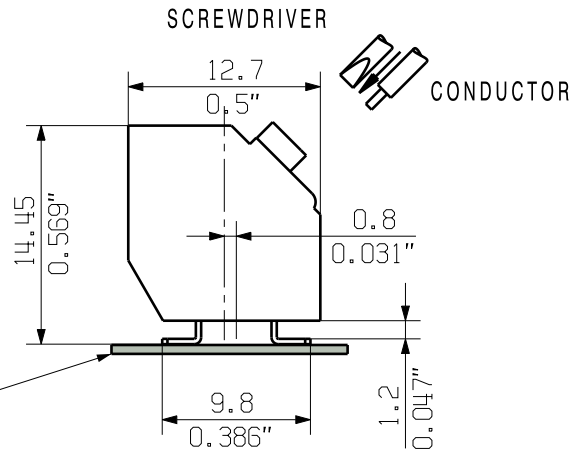
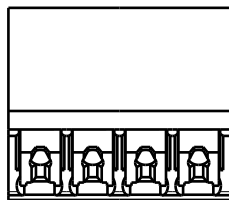
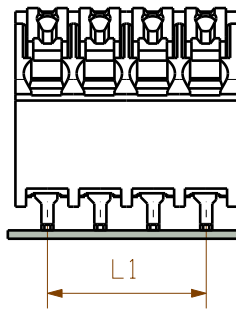
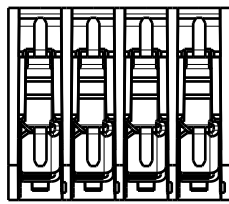

LAYOUT  
1:1

For the mounting on PCBs, it should be noted that the rated data relates only to the PCB components alone.

The necessary creepage and clearance paths must be observed in the relevant equipment standards in accordance with IEC 664 / VDE 0110.

The current-carrying capacity and pitch tolerance is to be determined according to DIN IEC 326 part 3.

Weidmüller PCB components are rated in accordance with the DIN EN 61984 standard, and are valid for its field of application. If the components are used in accordance with the intended purpose, the components will meet all requirements with respect to the occurring of electrical, mechanical, thermic and corrosive stress.

SHOWN: LSF-SMD 3.50/04/135...

12	38,5	1,516
11	35,0	1,378
10	31,5	1,240
9	28,0	1,102
8	24,5	0,965
7	21,0	0,827
6	17,5	0,689
5	14,0	0,551
4	10,5	0,413
3	7,0	0,276
2	3,5	0,138
n	L1 [mm]	L1 [Inch]

	86128/5 25.01.16 KRUG_M 01		CAT.NO.: . . .	
	DIN ISO 2768-m		<b>Weidmüller</b>	
MODIFICATION		<b>C 57457</b>		DRAWING NO. ISSUE NO.
DATE NAME		SHEET 01 OF 04 SHEETS		<b>LSF-SMD 3.50/./135</b> LEITERPLATTENKLEMME PCB TERMINAL
DRAWN 03.06.2015 KRUG_M		PRODUCT FILE: LSF-SMD 3.50		
RESPONSIBLE KRUG_M		7358		
CHECKED 02.02.2016 HELIS_MA		.		
SCALE: 2:1		APPROVED LANG_T		
SUPERSEDES: .		PRODUCT FILE: LSF-SMD 3.50		

WEITERGABE SOWIE Vervielfaeltigung dieses Dokuments, Verwertung und Mitteilung seines Inhalts sind verboten, soweit nicht ausdruendlich gestattet.  
 ZUWIDERHANDLUNGEN VERPFLICHTEN ZU SCHADENERSATZ. ALLE RECHTE FUER DEN FALL DER PATENT-, GEBRAUCHSMUSTER- ODER GESCHMACKSMUSTEREINTRAGUNG VORBEHALTEN.  
 THE REPRODUCTION, DISTRIBUTION AND UTILIZATION OF THIS DOCUMENT AS WELL AS THE COMMUNICATION OF ITS CONTENTS TO OTHERS WITHOUT EXPLICIT AUTHORIZATION IS PROHIBITED.  
 OFFENDERS WILL BE HELD LIABLE FOR THE PAYMENT OF DAMAGES. WEIDMUELLER EXCLUSIVELY RESERVES THE RIGHT TO FILE FOR PATENTS, UTILITY MODELS OR DESIGNS.  
 © WEIDMUELLER INTERFACE GmbH & Co.KG

## Recommended reflow soldering profile

**Weidmüller Interface GmbH & Co. KG**  
 Klingenbergstraße 16  
 D-32758 Detmold  
 Germany  
 Fon: +49 5231 14-0  
 Fax: +49 5231 14-292083  
 www.weidmueller.com

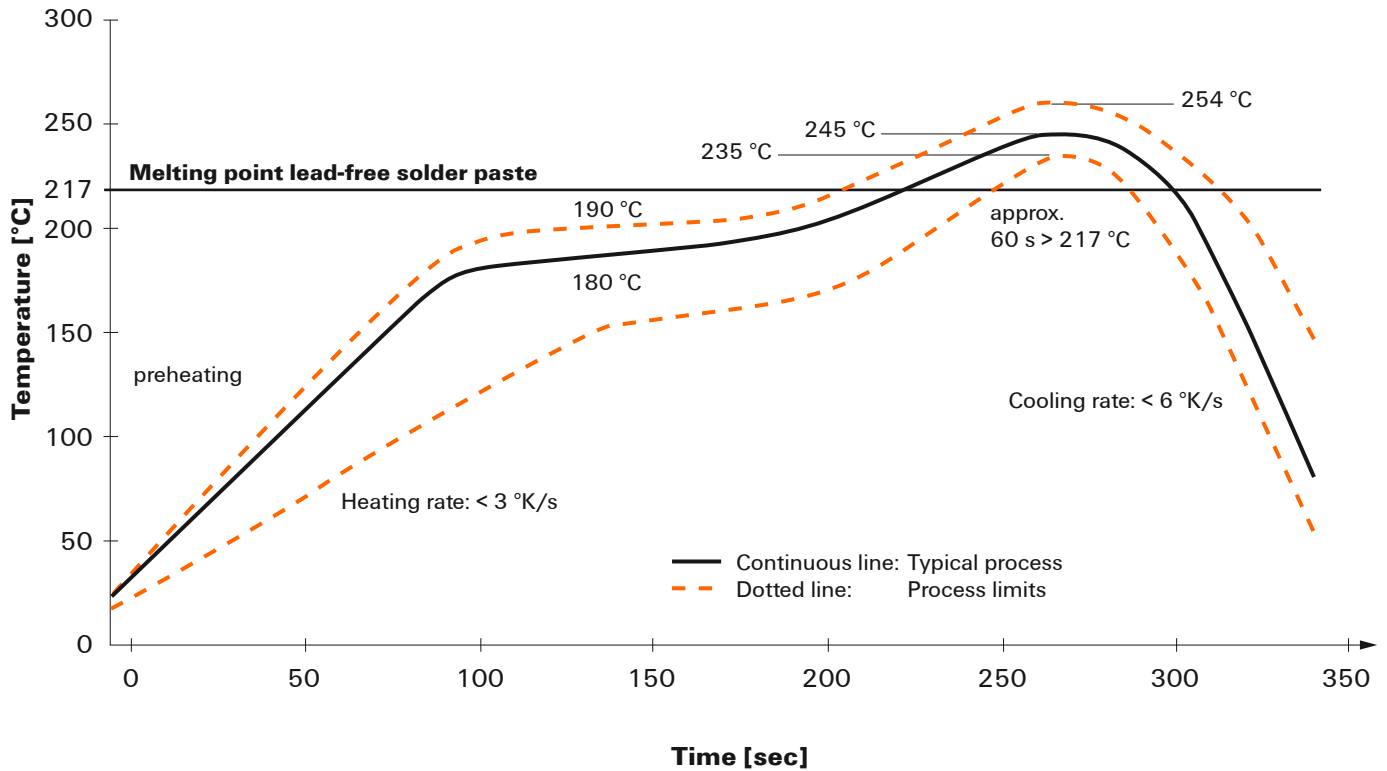

### Reflow soldering profile

The perfect soldering profile for SMT Surface Mount Technology is one the most exiting question in SMT production. But there are more than one correct answer: The diagram of temperature-on-time is related to processing features of solder paste and to maximum load of components.

We have to consider the following parameters:

- Time for pre heating
- Maximum temperature
- Time above melting point
- Time for cooling
- Maximum heating rate
- Maximum cooling rate

We recommend a typical solder profile with associated process limits. With preheating components and board are prepared smoothly for the solder phase. Heating rate is typically  $\leq +3\text{K/s}$ . In parallel the solder paste is ‚activated‘. The time above melting point of  $217^\circ\text{C}$  the paste gets liquid and components and boards begin to connect. The maximum temperature of  $245^\circ\text{C}$  to  $254^\circ\text{C}$  should stay between 10 and 40 seconds. In the cooling phase at  $\geq -6\text{K/s}$  solder is cured. Board and components cool down while avoiding cold cracks.