

# Silicon Carbide (SiC) MOSFET – 70 mohm, 650 V, M2, D2PAK-7L NVBG095N065SC1

## Features

- Typ.  $R_{DS(on)} = 70\text{ m}\Omega @ V_{GS} = 18\text{ V}$   
Typ.  $R_{DS(on)} = 95\text{ m}\Omega @ V_{GS} = 15\text{ V}$
- Ultra Low Gate Charge ( $Q_{G(tot)} = 50\text{ nC}$ )
- Low Output Capacitance ( $C_{oss} = 89\text{ pF}$ )
- 100% Avalanche Tested
- AEC-Q101 Qualified and PPAP Capable
- RoHS Compliant

## Typical Applications

- Automotive On Board Charger
- Automotive DC/DC Converter for EV/HEV

## MAXIMUM RATINGS ( $T_J = 25^\circ\text{C}$ unless otherwise noted)

| Parameter   |              | Symbol                                  | Value       | Unit             |   |
|---|--------------|---|-------------|------------------|---|
| Drain-to-Source Voltage   |              | $V_{DSS}$                               | 650         | V                |   |
| Gate-to-Source Voltage  |              | $V_{GS}$                                | -8/+22      | V                |   |
| Recommended Operation Values of Gate - Source Voltage   |              | $T_C < 175^\circ\text{C}$<br>$V_{GSop}$ | -5/+18      | V                |   |
| Continuous Drain Current (Note 2)   | Steady State | $T_C = 25^\circ\text{C}$                | $I_D$       | 30               | A |
|   |              |   | $P_D$       | 110              | W |
| Continuous Drain Current (Notes 1, 2)   | Steady State | $T_C = 100^\circ\text{C}$               | $I_D$       | 21               | A |
|   |              |   | $P_D$       | 55               | W |
| Pulsed Drain Current (Note 3)   |              | $T_C = 25^\circ\text{C}$                | $I_{DM}$    | 79               | A |
| Operating Junction and Storage Temperature Range  |              | $T_J, T_{stg}$                          | -55 to +175 | $^\circ\text{C}$ |   |
| Source Current (Body Diode)   |              | $I_S$                                   | 24          | A                |   |
| Single Pulse Drain-to-Source Avalanche Energy ( $I_L = 9.4\text{ A}_{pk}, L = 1\text{ mH}$ ) (Note 4) |              | $E_{AS}$                                | 44          | mJ               |   |
| Maximum Lead Temperature for Soldering, 1/8" from Case for 10 Seconds                                 |              | $T_L$                                   | 260         | $^\circ\text{C}$ |   |

Stresses exceeding those listed in the Maximum Ratings table may damage the device. If any of these limits are exceeded, device functionality should not be assumed, damage may occur and reliability may be affected.

1. Surface mounted on a FR-4 board using 1 in<sup>2</sup> pad of 2 oz copper.
2. The entire application environment impacts the thermal resistance values shown, they are not constants and are only valid for the particular conditions noted.
3. Repetitive rating, limited by max junction temperature.
4.  $E_{AS}$  of 44 mJ is based on starting  $T_J = 25^\circ\text{C}$ ;  $L = 1\text{ mH}$ ,  $I_{AS} = 9.4\text{ A}$ ,  $V_{DD} = 50\text{ V}$ ,  $V_{GS} = 18\text{ V}$ .

| $V_{(BR)DSS}$ | $R_{DS(ON)}\text{ MAX}$ | $I_D\text{ MAX}$ |
|---------------|-------------------------|------------------|
| 650 V         | 105 m $\Omega$ @ 18 V   | 30 A             |

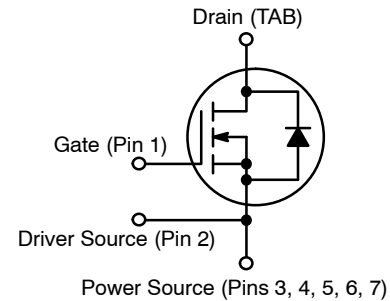

N-CHANNEL MOSFET

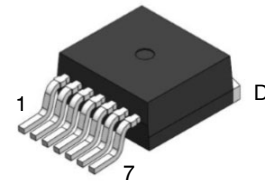

D2PAK-7L  
CASE 418BJ

## MARKING DIAGRAM

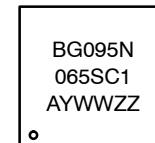

BG095N065SC1 = Specific Device Code  
A = Assembly Location  
Y = Year  
WW = Work Week  
ZZ = Lot Traceability

## ORDERING INFORMATION

See detailed ordering and shipping information on page 6 of this data sheet.

# NVBG095N065SC1

## THERMAL CHARACTERISTICS

| Parameter   | Symbol          | Typ  | Max | Units |
|---|-----------------|------|-----|-------|
| Thermal Resistance Junction-to-Case (Note 2)        | $R_{\theta JC}$ | 1.36 | –   | °C/W  |
| Thermal Resistance Junction-to-Ambient (Notes 1, 2) | $R_{\theta JA}$ | –    | 40  | °C/W  |

## ELECTRICAL CHARACTERISTICS ( $T_J = 25^\circ\text{C}$ unless otherwise stated)

| Parameter   | Symbol            | Test Condition  | Min                                | Typ  | Max | Unit          |
|---|-------------------|---|------------------------------------|------|-----|---------------|
| <b>OFF CHARACTERISTICS</b>                                |                   |   |                                    |      |     |               |
| Drain-to-Source Breakdown Voltage                         | $V_{(BR)DSS}$     | $V_{GS} = 0\text{ V}, I_D = 1\text{ mA}$                    | 650                                |      |     | V             |
| Drain-to-Source Breakdown Voltage Temperature Coefficient | $V_{(BR)DSS}/T_J$ | $I_D = 20\text{ mA}$ , refer to $25^\circ\text{C}$ (Note 5) |                                    | 0.15 |     | V/°C          |
| Zero Gate Voltage Drain Current                           | $I_{DSS}$         | $V_{GS} = 0\text{ V}$<br>$V_{DS} = 650\text{ V}$            | $T_J = 25^\circ\text{C}$           |      | 10  | $\mu\text{A}$ |
|   |                   |   | $T_J = 175^\circ\text{C}$ (Note 5) |      | 1   | mA            |
| Gate-to-Source Leakage Current                            | $I_{GSS}$         | $V_{GS} = +18/-5\text{ V}, V_{DS} = 0\text{ V}$             |                                    |      | 250 | nA            |

## ON CHARACTERISTICS

|                               |              |   |     |     |     |            |
|-------------------------------|--------------|---|-----|-----|-----|------------|
| Gate Threshold Voltage        | $V_{GS(TH)}$ | $V_{GS} = V_{DS}, I_D = 4\text{ mA}$  | 1.8 | 2.8 | 4.3 | V          |
| Recommended Gate Voltage      | $V_{GOP}$    |   | –5  |     | +18 | V          |
| Drain-to-Source On Resistance | $R_{DS(on)}$ | $V_{GS} = 15\text{ V}, I_D = 12\text{ A}, T_J = 25^\circ\text{C}$           |     | 95  |     | m $\Omega$ |
|                               |              | $V_{GS} = 18\text{ V}, I_D = 12\text{ A}, T_J = 25^\circ\text{C}$           |     | 70  | 105 |            |
|                               |              | $V_{GS} = 18\text{ V}, I_D = 12\text{ A}, T_J = 175^\circ\text{C}$ (Note 5) |     | 85  |     |            |
| Forward Transconductance      | $g_{FS}$     | $V_{DS} = 10\text{ V}, I_D = 12\text{ A}$ (Note 5)                          |     | 6.9 |     | S          |

## CHARGES, CAPACITANCES & GATE RESISTANCE

|                              |              |  |  |     |  |          |
|------------------------------|--------------|--|--|-----|--|----------|
| Input Capacitance            | $C_{ISS}$    | $V_{GS} = 0\text{ V}, f = 1\text{ MHz},$<br>$V_{DS} = 325\text{ V}$<br>(Note 5)      |  | 956 |  | pF       |
| Output Capacitance           | $C_{OSS}$    |  |  | 89  |  |          |
| Reverse Transfer Capacitance | $C_{RSS}$    |  |  | 7.8 |  |          |
| Total Gate Charge            | $Q_{G(TOT)}$ | $V_{GS} = -5/18\text{ V}, V_{DS} = 520\text{ V},$<br>$I_D = 12\text{ A}$<br>(Note 5) |  | 50  |  | nC       |
| Gate-to-Source Charge        | $Q_{GS}$     |  |  | 14  |  |          |
| Gate-to-Drain Charge         | $Q_{GD}$     |  |  | 15  |  |          |
| Gate-Resistance              | $R_G$        | $f = 1\text{ MHz}$   |  | 7.6 |  | $\Omega$ |

## SWITCHING CHARACTERISTICS

|                         |              |  |  |    |  |               |
|-------------------------|--------------|--|--|----|--|---------------|
| Turn-On Delay Time      | $t_{d(ON)}$  | $V_{GS} = -5/18\text{ V}, V_{DS} = 400\text{ V},$<br>$I_D = 12\text{ A}, R_G = 2.2\text{ }\Omega,$<br>Inductive Load<br>(Note 5) |  | 8  |  | ns            |
| Rise Time               | $t_r$        |  |  | 12 |  |               |
| Turn-Off Delay Time     | $t_{d(OFF)}$ |  |  | 20 |  |               |
| Fall Time               | $t_f$        |  |  | 9  |  |               |
| Turn-On Switching Loss  | $E_{ON}$     |  |  | 34 |  | $\mu\text{J}$ |
| Turn-Off Switching Loss | $E_{OFF}$    |  |  | 11 |  |               |
| Total Switching Loss    | $E_{TOT}$    |  |  | 45 |  |               |

## SOURCE-DRAIN DIODE CHARACTERISTICS

|  |           |  |  |     |    |   |
|--|-----------|--|--|-----|----|---|
| Continuous Source-Drain Diode Forward Current      | $I_{SD}$  | $V_{GS} = -5\text{ V}, T_J = 25^\circ\text{C}$<br>(Note 5)           |  |     | 24 | A |
| Pulsed Source-Drain Diode Forward Current (Note 3) | $I_{SDM}$ | $V_{GS} = -5\text{ V}, T_J = 25^\circ\text{C}$<br>(Note 5)           |  |     | 79 | A |
| Forward Diode Voltage                              | $V_{SD}$  | $V_{GS} = -5\text{ V}, I_{SD} = 12\text{ A}, T_J = 25^\circ\text{C}$ |  | 4.5 |    | V |

# NVBG095N065SC1

## ELECTRICAL CHARACTERISTICS (T<sub>J</sub> = 25°C unless otherwise stated)

| Parameter | Symbol | Test Condition | Min | Typ | Max | Unit |
|-----------|--------|----------------|-----|-----|-----|------|
|-----------|--------|----------------|-----|-----|-----|------|

### SOURCE-DRAIN DIODE CHARACTERISTICS

| Parameter                     | Symbol           | Test Condition  | Min | Typ | Max | Unit |
|-------------------------------|------------------|---|-----|-----|-----|------|
| Reverse Recovery Time         | t <sub>RR</sub>  | V <sub>GS</sub> = -5/18 V, I <sub>SD</sub> = 12 A,<br>dI <sub>S</sub> /dt = 1000 A/μs<br>(Note 5) |     | 15  |     | ns   |
| Reverse Recovery Charge       | Q <sub>RR</sub>  |   |     | 62  |     | nC   |
| Reverse Recovery Energy       | E <sub>REC</sub> |   |     | 6.5 |     | μJ   |
| Peak Reverse Recovery Current | I <sub>RRM</sub> |   |     | 8   |     | A    |
| Charge time                   | T <sub>a</sub>   |   |     | 8   |     | ns   |
| Discharge time                | T <sub>b</sub>   |   |     | 7   |     | ns   |

Product parametric performance is indicated in the Electrical Characteristics for the listed test conditions, unless otherwise noted. Product performance may not be indicated by the Electrical Characteristics if operated under different conditions.

5. Define by design, not subject to production test.

TYPICAL CHARACTERISTICS

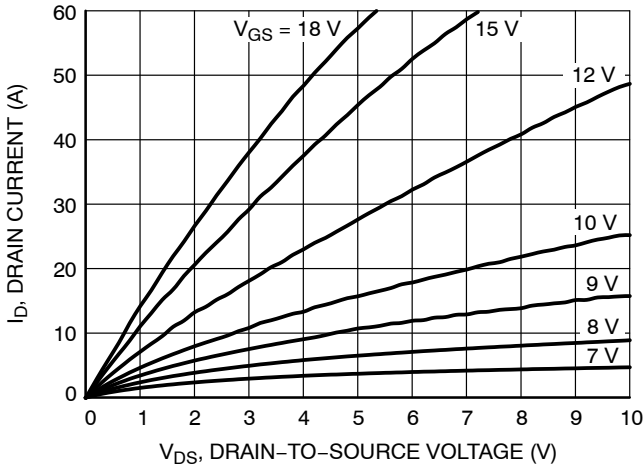

Figure 1. On-Region Characteristics

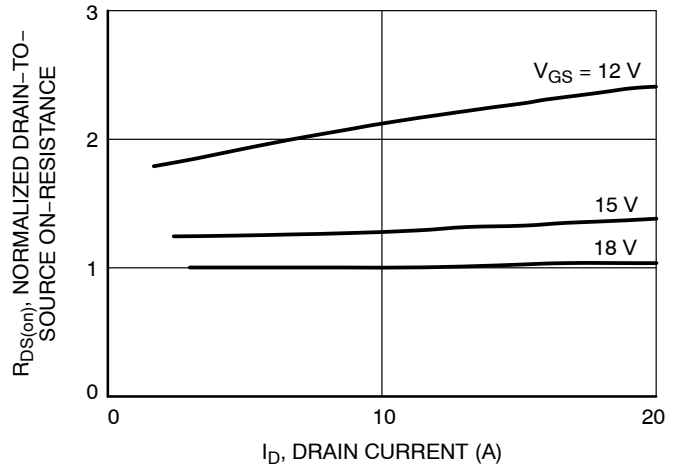

Figure 2. Normalized On-Resistance vs. Drain Current and Gate Voltage

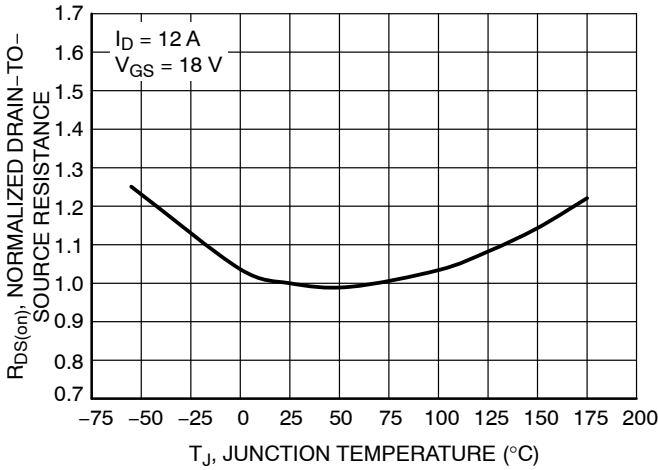

Figure 3. On-Resistance Variation with Temperature

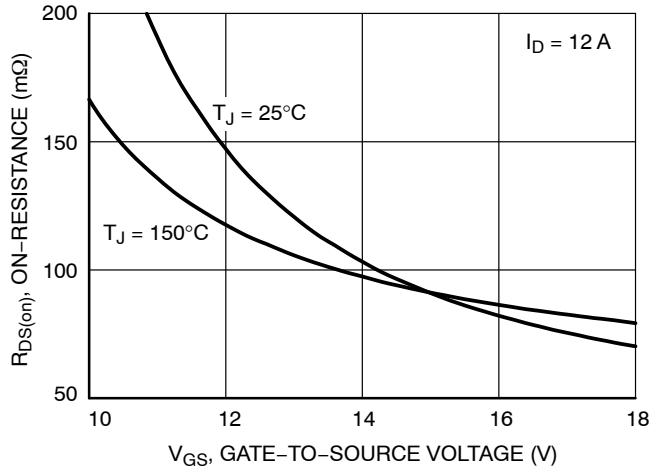

Figure 4. On-Resistance vs. Gate-to-Source Voltage

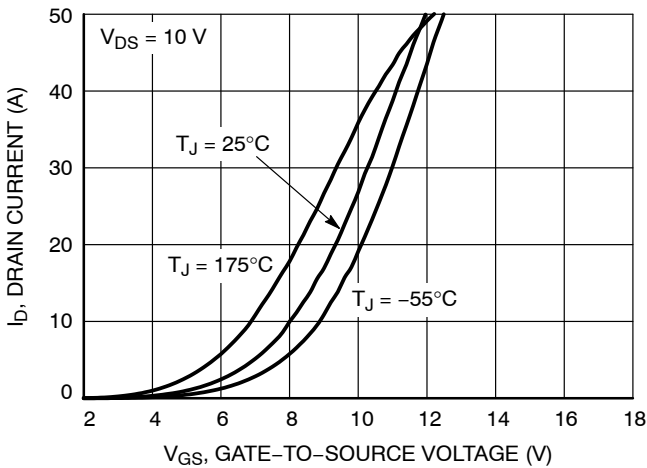

Figure 5. Transfer Characteristics

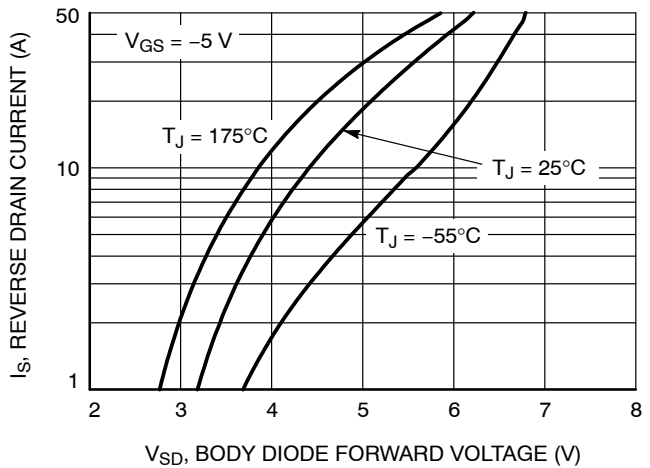

Figure 6. Diode Forward Voltage vs. Current

TYPICAL CHARACTERISTICS

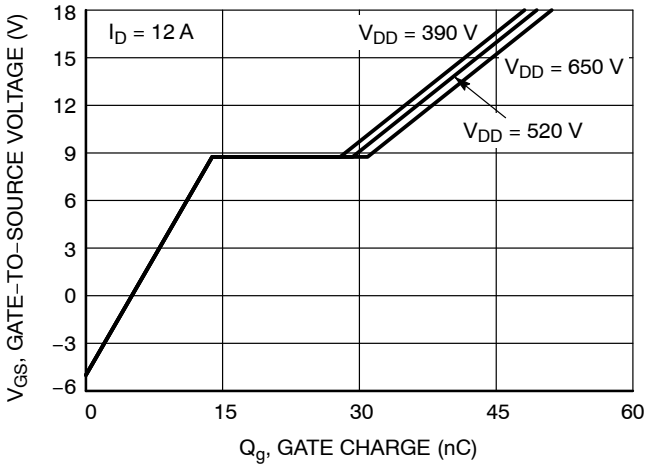

Figure 7. Gate-to-Source Voltage vs. Total Charge

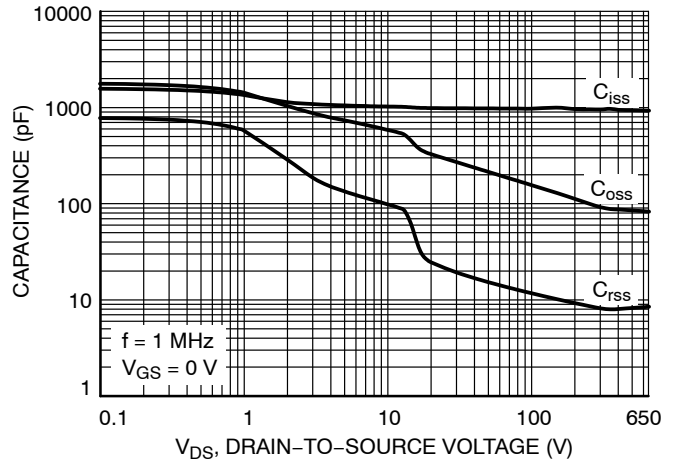

Figure 8. Capacitance vs. Drain-to-Source Voltage

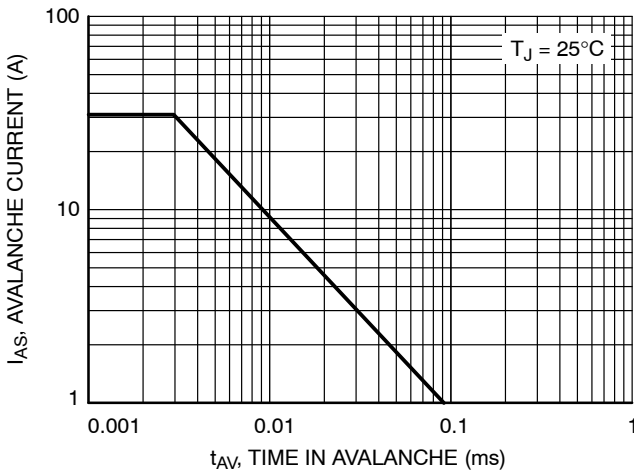

Figure 9. Unclamped Inductive Switching Capability

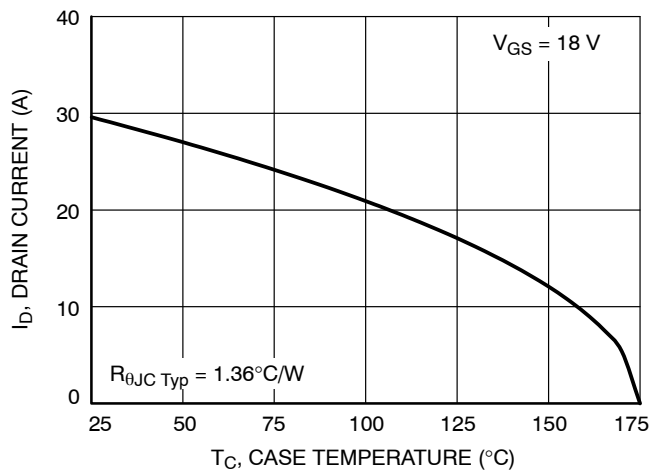

Figure 10. Maximum Continuous Drain Current vs. Case Temperature

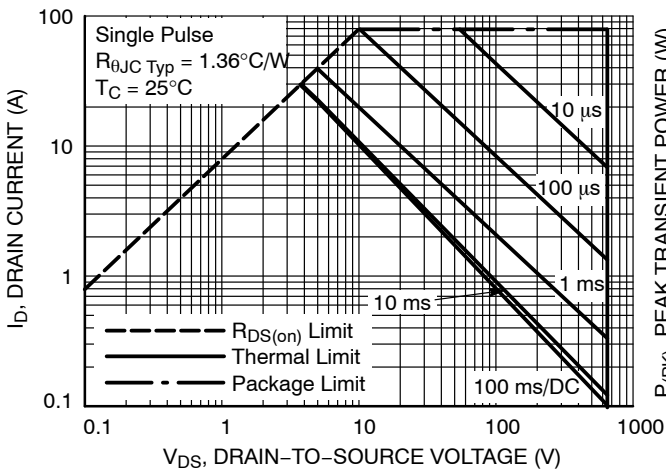

Figure 11. Safe Operating Area

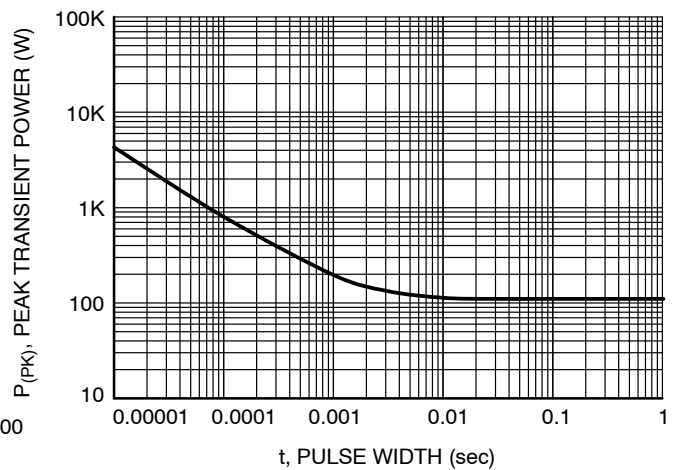

Figure 12. Single Pulse Maximum Power Dissipation

# NVBG095N065SC1

## TYPICAL CHARACTERISTICS

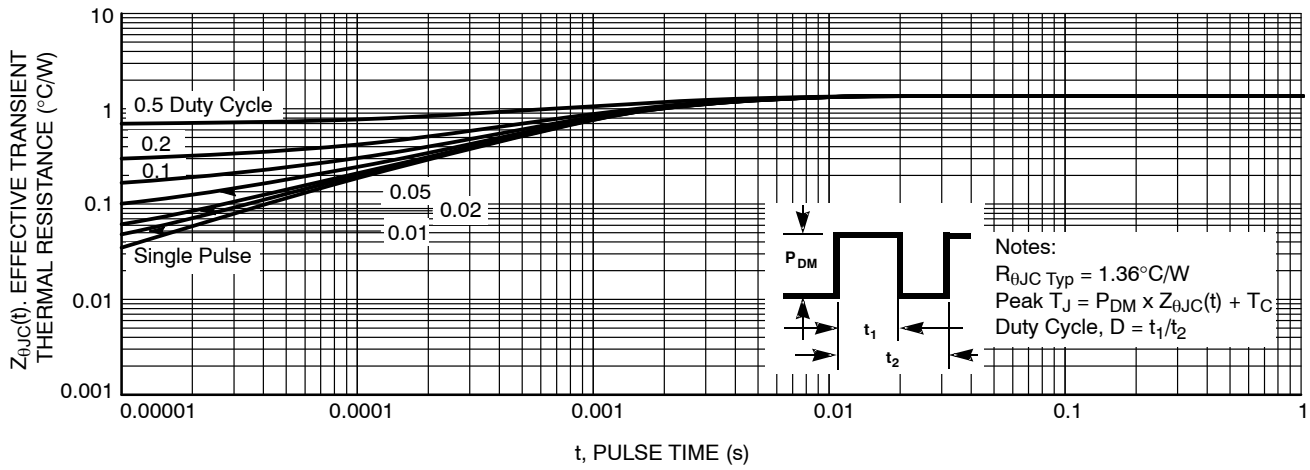

Figure 13. Junction-to-Case Thermal Response

### DEVICE ORDERING INFORMATION

| Device         | Package  | Shipping <sup>†</sup> |
|----------------|----------|-----------------------|
| NVBG095N065SC1 | D2PAK-7L | 800 / Tape & Reel     |

<sup>†</sup>For information on tape and reel specifications, including part orientation and tape sizes, please refer to our Tape and Reel Packaging Specifications Brochure, BRD8011/D.

# NVBG095N065SC1

## PACKAGE DIMENSIONS

**D<sup>2</sup>PAK7 (TO-263-7L HV)**  
CASE 418BJ  
ISSUE B

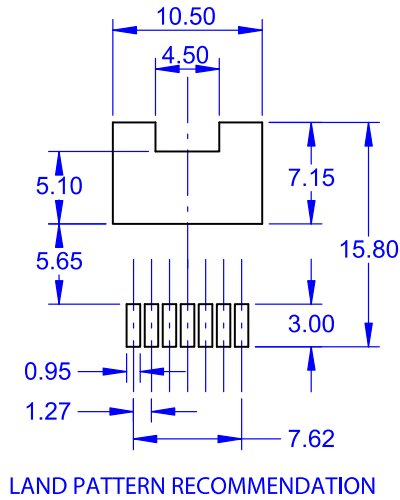
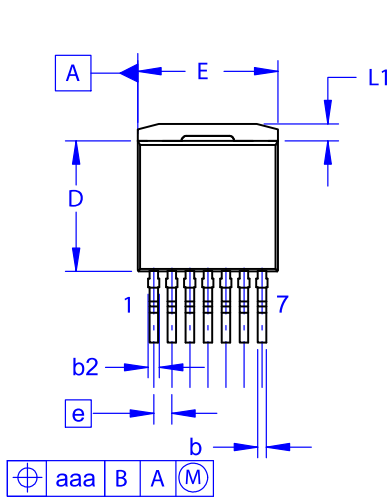

**NOTES:**

- A. PACKAGE CONFORMS TO JEDEC TO-263 VARIATION CB EXCEPT WHERE NOTED.
- B. ALL DIMENSIONS ARE IN MILLIMETERS.
- C. OUT OF JEDEC STANDARD VALUE.
- D. DIMENSION AND TOLERANCE AS PER ASME Y14.5-2009.
- E. DIMENSIONS ARE EXCLUSIVE OF BURRS, MOLD FLASH AND TIE BAR PROTRUSIONS.

| DIM | MILLIMETERS |       |       |
|-----|-------------|-------|-------|
|     | MIN         | NOM   | MAX   |
| A   | 4.30        | 4.50  | 4.70  |
| A1  | 0.00        | 0.10  | 0.20  |
| b2  | 0.60        | 0.70  | 0.80  |
| b   | 0.51        | 0.60  | 0.70  |
| c   | 0.40        | 0.50  | 0.60  |
| c2  | 1.20        | 1.30  | 1.40  |
| D   | 9.00        | 9.20  | 9.40  |
| D1  | 6.15        | 6.80  | 7.15  |
| E   | 9.70        | 9.90  | 10.20 |
| E1  | 7.15        | 7.65  | 8.15  |
| e   | ~           | 1.27  | ~     |
| H   | 15.10       | 15.40 | 15.70 |
| L   | 2.44        | 2.64  | 2.84  |
| L1  | 1.00        | 1.20  | 1.40  |
| L3  | ~           | 0.25  | ~     |
| aaa | ~           | ~     | 0.25  |

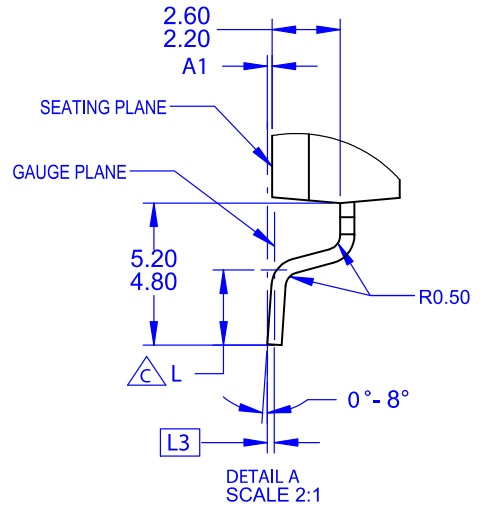
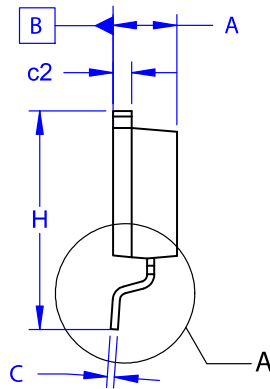
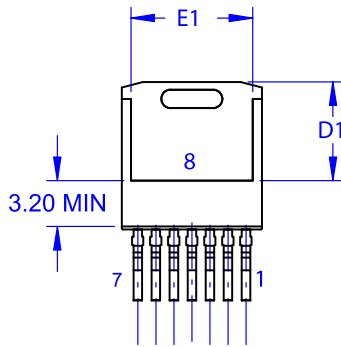

# NVVG095N065SC1

**onsemi**, **Onsemi**, and other names, marks, and brands are registered and/or common law trademarks of Semiconductor Components Industries, LLC dba "**onsemi**" or its affiliates and/or subsidiaries in the United States and/or other countries. **onsemi** owns the rights to a number of patents, trademarks, copyrights, trade secrets, and other intellectual property. A listing of **onsemi**'s product/patent coverage may be accessed at [www.onsemi.com/site/pdf/Patent-Marking.pdf](http://www.onsemi.com/site/pdf/Patent-Marking.pdf). **onsemi** reserves the right to make changes at any time to any products or information herein, without notice. The information herein is provided "as-is" and **onsemi** makes no warranty, representation or guarantee regarding the accuracy of the information, product features, availability, functionality, or suitability of its products for any particular purpose, nor does **onsemi** assume any liability arising out of the application or use of any product or circuit, and specifically disclaims any and all liability, including without limitation special, consequential or incidental damages. Buyer is responsible for its products and applications using **onsemi** products, including compliance with all laws, regulations and safety requirements or standards, regardless of any support or applications information provided by **onsemi**. "Typical" parameters which may be provided in **onsemi** data sheets and/or specifications can and do vary in different applications and actual performance may vary over time. All operating parameters, including "Typicals" must be validated for each customer application by customer's technical experts. **onsemi** does not convey any license under any of its intellectual property rights nor the rights of others. **onsemi** products are not designed, intended, or authorized for use as a critical component in life support systems or any FDA Class 3 medical devices or medical devices with a same or similar classification in a foreign jurisdiction or any devices intended for implantation in the human body. Should Buyer purchase or use **onsemi** products for any such unintended or unauthorized application, Buyer shall indemnify and hold **onsemi** and its officers, employees, subsidiaries, affiliates, and distributors harmless against all claims, costs, damages, and expenses, and reasonable attorney fees arising out of, directly or indirectly, any claim of personal injury or death associated with such unintended or unauthorized use, even if such claim alleges that **onsemi** was negligent regarding the design or manufacture of the part. **onsemi** is an Equal Opportunity/Affirmative Action Employer. This literature is subject to all applicable copyright laws and is not for resale in any manner.

## PUBLICATION ORDERING INFORMATION

### LITERATURE FULFILLMENT:

Email Requests to: [orderlit@onsemi.com](mailto:orderlit@onsemi.com)

**onsemi** Website: [www.onsemi.com](http://www.onsemi.com)

### TECHNICAL SUPPORT

North American Technical Support:

Voice Mail: 1 800-282-9855 Toll Free USA/Canada

Phone: 011 421 33 790 2910

Europe, Middle East and Africa Technical Support:

Phone: 00421 33 790 2910

For additional information, please contact your local Sales Representative