

MGV Small Size Power Inductors MGV322512 Series

FEATURES AND APPLICATIONS

Laird MGV series high current power inductors improve performance, reliability and power efficiency. A lower profile benefits consumer electronics and telecom design. Products feature extremely low DCR with greater efficiency and enable a large current in a small size. Inductors are of magnetic shielding and molded construction and perform in operating temperatures ranging from -40 C to 125 C including self-heating rise in temperature.

FEATURES

- High saturation current and soft saturation realized by optimized coil and high performance powder
- Metal alloy composite molded construction
- Low profile and very compact in size
- Low DCR

APPLICATIONS

- Industrial DC to DC power lines
- Telecom and Datacom DC to DC power lines
- DC to DC converter with low power loss, low voltage and high output current such as CPU ,VRM, etc
- DC to DC power lines in consumer electronics



PART NUMBER EXPLANATION

MGV 322512 1R0 M - 10

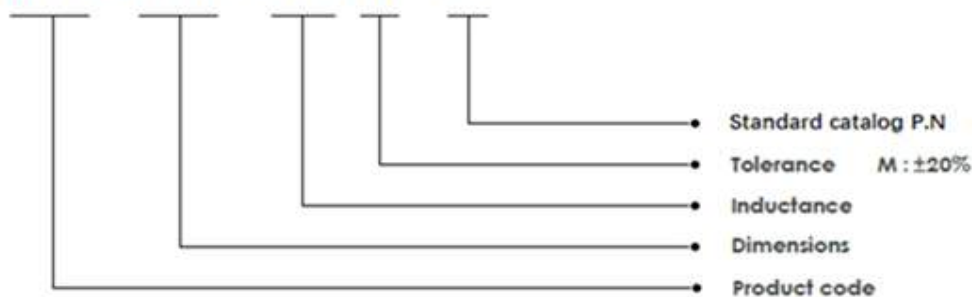

ELECTRICAL SPECIFICATIONS

- Inductance tested at 1MHz, 1V
- Heat Rated Current (Irms) is defined based on temperature rise approximate 40°C without core loss (ambient temperature 25±5°C)
- Saturation Current (Isat) is the DC current at which the inductance drops off approximately 30% from its value without current. (ambient temperature 25±5°C)
- Operating temperature range: -40°C~+125°C (including self-heating temperature rise)
- Storage temperature range (packaging conditions): -10°C~+40°C and RH 65%(MAX.)

Note: Heat Rated Current (Irms) is tested on a typical PCB and apply a constant current in still air. The temperature rise is dependent on the application system condition including PCB PAD pattern, trace width and thickness and adjacent components etc. It's suggested to verify the temperature rise of the component under the real operation application conditions.

1.MGV322512 SERIES DIMENSIONS

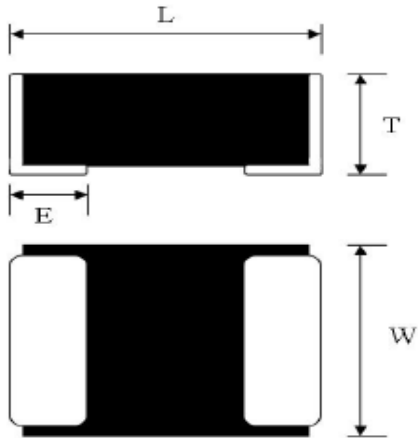

L [mm]	W [mm]	T [mm]	E [mm]
3.2±0.2	2.5±0.2	1.2 max.	0.6±0.2

Recommend Land Pattern Dimensions :

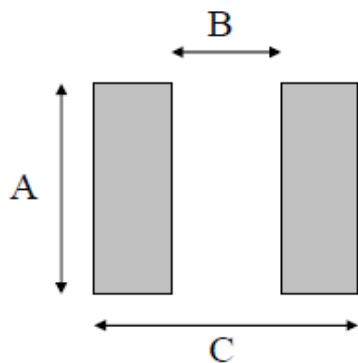

A [mm]	B [mm]	C [mm]
2.5 typ.	1.7 typ.	3.2 typ.

2.SPECIFICATION

PART NUMBER	INDUCTANCE (uH)	I _{rms} (A)	I _{sat} (A)	DCR(mΩ) Typ	DCR(mΩ) Max	REMARK
MGV322512R47M-10	0.47±20%	5.20	7.00	15.00	19.00	
MGV322512R68M-10	0.68±20%	4.70	5.80	16.00	20.00	
MGV3225121R0M-10	1.0±20%	4.40	5.00	25.00	32.00	
MGV3225122R2M-10	2.2±20%	2.70	3.50	60.00	72.00	
MGV3225124R7M-10	4.7±20%	1.40	2.40	150.00	168.00	
MGV3225126R8M-10	6.8±20%	1.20	2.10	190.00	210.00	

3.EQUIVALENT CIRCUIT

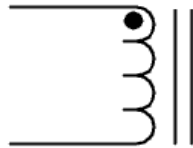

4.MATERIAL LIST

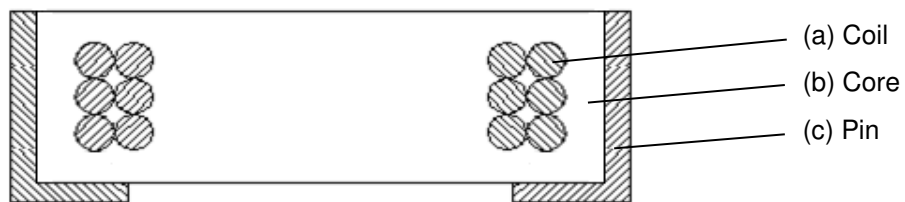

5. CHARACTERISTICS CURVES

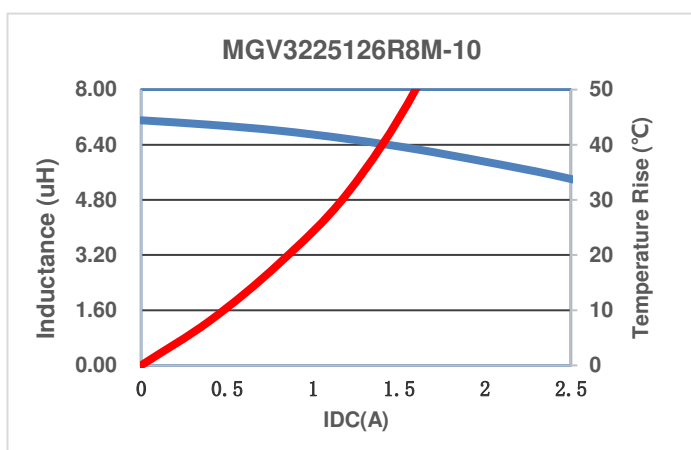
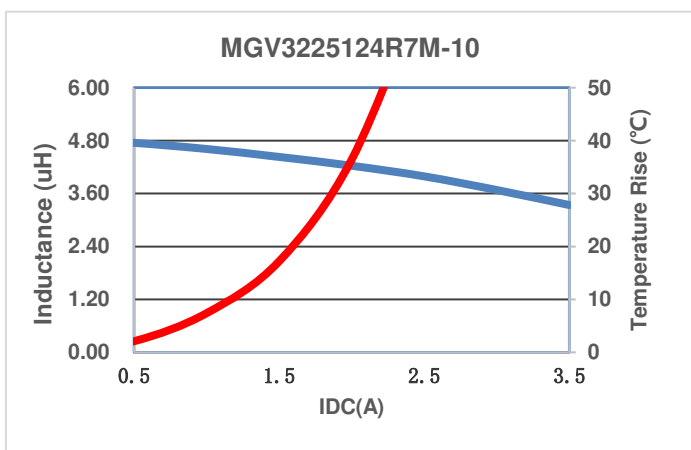
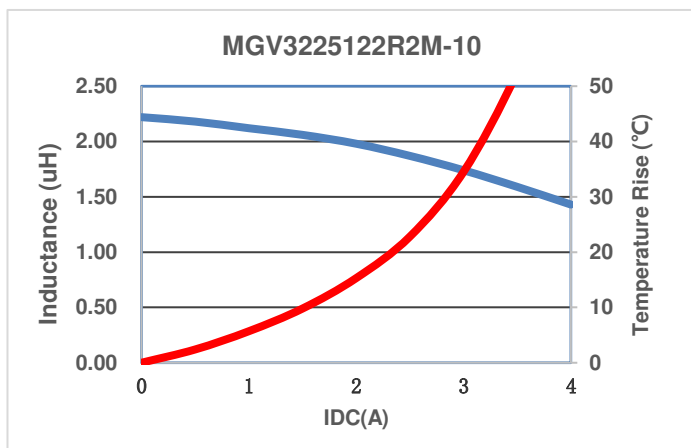
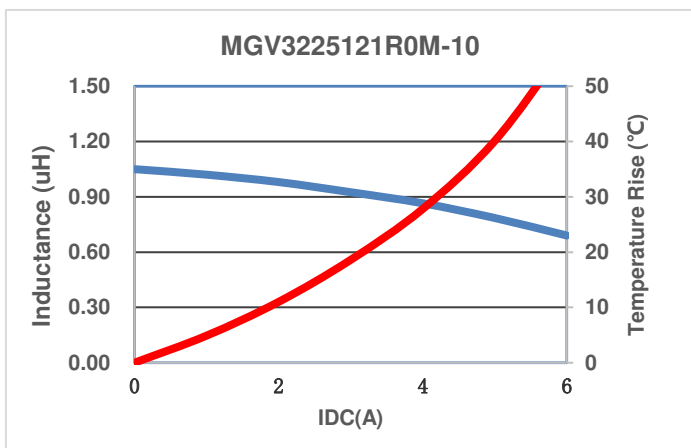
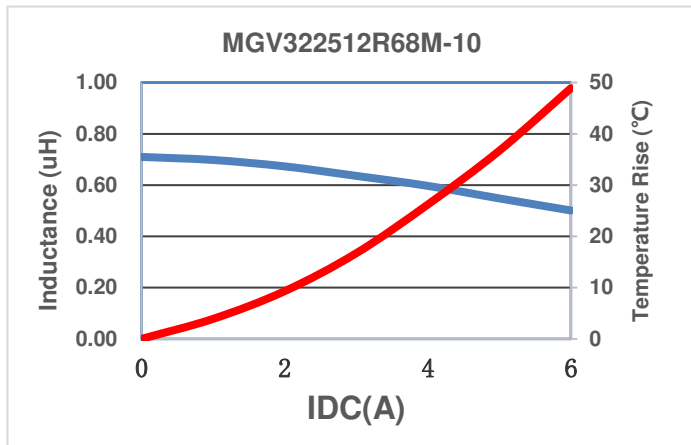
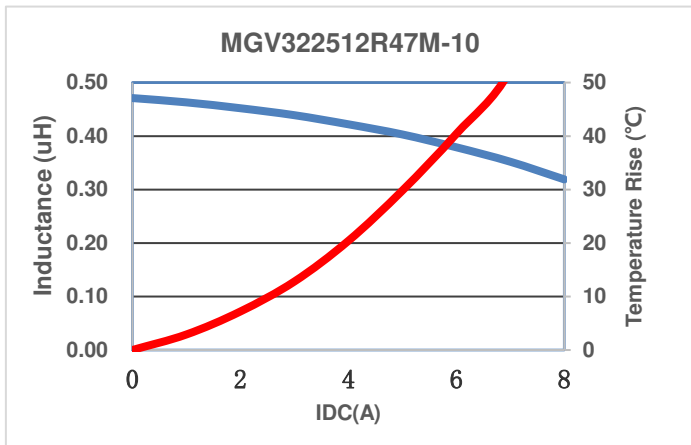

6. SOLDERING

Mildly activated rosin fluxes are preferred.

Recommended temperature profiles for re - flow soldering in Figure 1 .

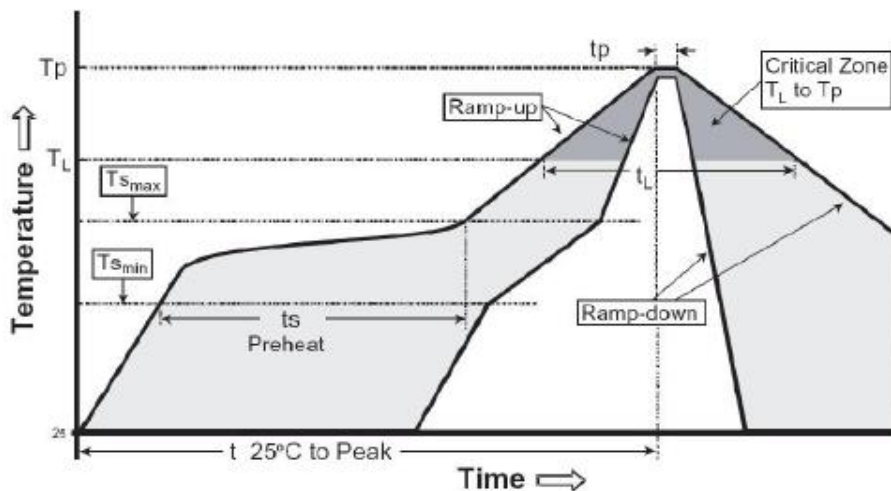

Reference IPC-020c-5-1

Profile Feature	Pb free Assembly
Average Ramp Rate (Ts max to Tp)	3°C/second max
Preheat	
- Temperature Min (T _{Smin})	150°C
- Temperature Min (T _{Smax})	200°C
- Time(t _{Smin} to t _{Smin})	60-180 seconds
Time maintained above:	
- Temperature (T _L)	217°C
- Time (t _L)	60-150 seconds
Peak Temperature (T _p)	260°C +0/-5°C
Time within 5°C of actual Peak Temperature (T _p)	20-40 seconds
Ramp-Down Rate	6°C/second max.
Time 25°C to Peak Temperature	8 minutes max

7. PACKAGING

7-1 Reel Dimension

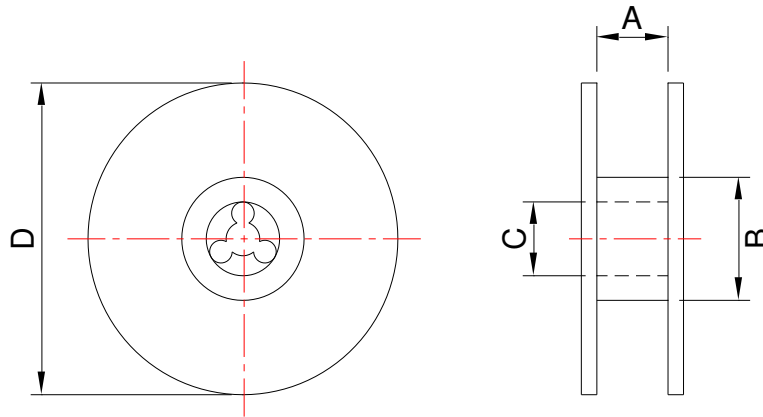

Type	A(mm)	B(mm)	C(mm)	D(mm)
7"x8	9.0±0.5	60.0 ± 0.5	13+0.5/-0.2	110±0.5

7-2 Tape Dimension

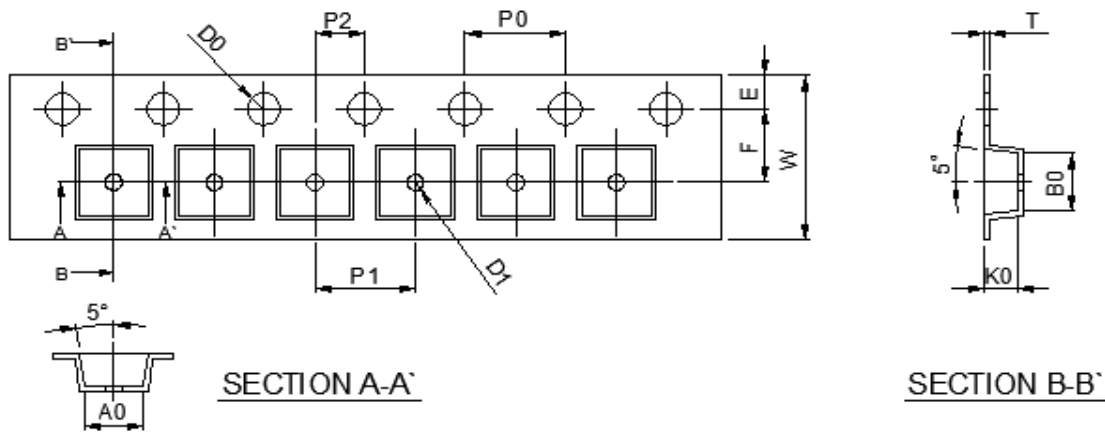

W	E	F	D0	D1	P0
8.0±0.2	1.75±0.1	3.5±0.1	1.5±0.1	1.0±0.1	4.0±0.1
P1	P2	t	A0	B0	K0
4.0±0.1	2.0±0.1	0.23±0.05	2.8±0.1	3.45±0.1	1.34±0.1

Size	Reel	Inner Box	Outer Box
MGV322512	3000	15000	15000*X

7-3 Tearing Off Force

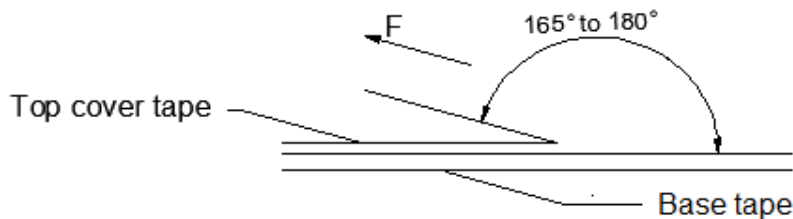

The force for tearing off cover tape is 10~100 grame in the arrow direction under the following conditions .

Room Temp (°C)	Room Humidity(%)	Room atm (hPa)	Tearing Speed mm/min
5~35	45~85	860~1060	300

8. Application Notice:

8-1.Storage Conditions:

To maintain the solderability of terminal electrodes:

- a) Recommended products should be used within 12 months from the time of delivery .
- b) The packaging materal should be kept where no chlorine or sulfur exists in the air .

8-2. Transportation:

- a) Products should be -handled with care to avoid damage or contamination from perspiration and skin oils .
- b) Vacuum pick up is strongly recommended for individual components .
- c) Bulk handling should ensure that abrasion and mechanical shock are minimized .

9. Cosmetic Specification

Cosmetic Specification refer to Laird WI-QA-143