

# Dual, SiGe High-Linearity, 1800MHz to 2900MHz Downconversion Mixer with LO Buffer

## General Description

The MAX19997A dual downconversion mixer is a versatile, highly integrated diversity downconverter that provides high linearity and low noise figure for a multitude of 1800MHz to 2900MHz base-station applications. The MAX19997A fully supports both low- and high-side LO injection architectures for the 2300MHz to 2900MHz WiMAX™, LTE, WCS, and MMDS bands, providing 8.7dB gain, +24dBm input IP3, and 10.3dB NF in the low-side configuration, and 8.7dB gain, +24dBm input IP3, and 10.4dB NF in the high-side configuration. High-side LO injection architectures can be further extended down to 1800MHz with the addition of one tuning element (a shunt inductor) on each RF port.

The device integrates baluns in the RF and LO ports, an LO buffer, two double-balanced mixers, and a pair of differential IF output amplifiers. The MAX19997A requires a typical LO drive of 0dBm and a supply current guaranteed below 420mA to achieve the targeted linearity performance.

The MAX19997A is available in a compact 6mm x 6mm, 36-pin TQFN lead-free package with an exposed pad. Electrical performance is guaranteed over the extended temperature range, from  $T_C = -40^\circ\text{C}$  to  $+100^\circ\text{C}$ .

## Applications

- 2.3GHz WCS Base Stations
- 2.5GHz WiMAX and LTE Base Stations
- 2.7GHz MMDS Base Stations
- UMTS/WCDMA and cdma2000® 3G Base Stations
- PCS1900 and EDGE Base Stations
- PHS/PAS Base Stations
- Fixed Broadband Wireless Access
- Wireless Local Loop
- Private Mobile Radios
- Military Systems

## Features

- ◆ 1800MHz to 2900MHz RF Frequency Range
- ◆ 1950MHz to 3400MHz LO Frequency Range
- ◆ 50MHz to 550MHz IF Frequency Range
- ◆ Supports Both Low-Side and High-Side LO Injection
- ◆ 8.7dB Conversion Gain
- ◆ +24dBm Input IP3
- ◆ 10.3dB Noise Figure
- ◆ +11.3dBm Input 1dB Compression Point
- ◆ 70dBc Typical 2 x 2 Spurious Rejection at PRF = -10dBm
- ◆ Dual Channels Ideal for Diversity Receiver Applications
- ◆ Integrated LO Buffer
- ◆ Integrated LO and RF Baluns for Single-Ended Inputs
- ◆ Low -3dBm to +3dBm LO Drive
- ◆ Pin Compatible with the MAX19999 3000MHz to 4000MHz Mixer
- ◆ Pin Similar to the MAX9995 and MAX19995/ MAX19995A 1700MHz to 2200MHz Mixers and the MAX9985 and MAX19985A 700MHz to 1000MHz Mixers
- ◆ 42dB Channel-to-Channel Isolation
- ◆ Single 5.0V or 3.3V Supply
- ◆ External Current-Setting Resistors Provide Option for Operating Device in Reduced-Power/Reduced-Performance Mode

## Ordering Information

PART	TEMP RANGE	PIN-PACKAGE
MAX19997AETX+	-40°C to +100°C	36 TQFN-EP*
MAX19997AETX+T	-40°C to +100°C	36 TQFN-EP*

+Denotes a lead(Pb)-free/RoHS-compliant package.

\*EP = Exposed pad.

T = Tape and reel.

WiMAX is a trademark of WiMAX Forum.

cdma2000 is a registered trademark of Telecommunications Industry Association.

Pin Configuration/Functional Block Diagram appears at end of data sheet.

**For pricing, delivery, and ordering information, please contact Maxim Direct at 1-888-629-4642, or visit Maxim's website at [www.maximintegrated.com](http://www.maximintegrated.com).**

# MAX19997A

## Dual, SiGe High-Linearity, 1800MHz to 2900MHz Downconversion Mixer with LO Buffer

### ABSOLUTE MAXIMUM RATINGS

V <sub>CC</sub> to GND	-0.3V to +5.5V
RF <sub>-</sub> , LO to GND	-0.3V to +0.3V
IFM <sub>-</sub> , IFD <sub>-</sub> , IFM <sub>SET</sub> , IFD <sub>SET</sub> , LO <sub>ADJ_M</sub> , LO <sub>ADJ_D</sub> to GND	-0.3V to (V <sub>CC</sub> + 0.3V)
RF <sub>-</sub> , LO Input Power	+15dBm
RF <sub>-</sub> , LO Current (RF <sub>-</sub> and LO is DC shorted to GND through balun)	50mA
Continuous Power Dissipation (Note 1)	6.5W

Operating Case Temperature Range (Note 4)	T <sub>C</sub> = -40°C to +100°C
Junction Temperature	+150°C
Storage Temperature Range	-65°C to +150°C
Lead Temperature (soldering, 10s)	+300°C
Soldering Temperature (reflow)	+260°C

### PACKAGE THERMAL CHARACTERISTICS

Junction-to-Ambient Thermal Resistance (θ <sub>JA</sub> ) (Notes 2, 3)	38°C/W
Junction-to-Board Thermal Resistance (θ <sub>JB</sub> )	12.2°C/W

Junction-to-Case Thermal Resistance (θ <sub>JC</sub> ) (Notes 1, 3)	7.4°C/W
---	---------

**Note 1:** Based on junction temperature  $T_J = T_C + (\theta_{JC} \times V_{CC} \times I_{CC})$ . This formula can be used when the temperature of the exposed pad is known while the device is soldered down to a PCB. See the *Applications Information* section for details. The junction temperature must not exceed +150°C.

**Note 2:** Junction temperature  $T_J = T_A + (\theta_{JA} \times V_{CC} \times I_{CC})$ . This formula can be used when the ambient temperature of the PCB is known. The junction temperature must not exceed +150°C.

**Note 3:** Package thermal resistances were obtained using the method described in JEDEC specification JESD51-7, using a four-layer board. For detailed information on package thermal considerations, refer to [www.maximintegrated.com/thermal-tutorial](http://www.maximintegrated.com/thermal-tutorial).

**Note 4:** T<sub>C</sub> is the temperature on the exposed pad of the package. T<sub>A</sub> is the ambient temperature of the device and PCB.

Stresses beyond those listed under "Absolute Maximum Ratings" may cause permanent damage to the device. These are stress ratings only, and functional operation of the device at these or any other conditions beyond those indicated in the operational sections of the specifications is not implied. Exposure to absolute maximum rating conditions for extended periods may affect device reliability.

### +5.0V SUPPLY DC ELECTRICAL CHARACTERISTICS

(Typical Application Circuit optimized for the **standard RF band (see Table 1)**, no input RF or LO signals applied, V<sub>CC</sub> = 4.75V to 5.25V, T<sub>C</sub> = -40°C to +85°C. Typical values are at V<sub>CC</sub> = 5.0V, T<sub>C</sub> = +25°C, unless otherwise noted. R<sub>1</sub>, R<sub>4</sub> = 750Ω, R<sub>2</sub>, R<sub>5</sub> = 698Ω.)

PARAMETER	SYMBOL	CONDITIONS	MIN	TYP	MAX	UNITS
Supply Voltage	V <sub>CC</sub>		4.75		5.25	V
Total Supply Current	I <sub>CC</sub>	V <sub>CC</sub> = 5.0V		388	420	mA
		V <sub>CC</sub> = 5.25V		390.4		
V <sub>CC</sub> (Pin 4) Supply Current (Main and Diversity Paths)		V <sub>CC</sub> = 5.25V		2.5		mA
V <sub>CC</sub> (Pin 10) Supply Current (Diversity Path)		V <sub>CC</sub> = 5.25V		8.9		mA
V <sub>CC</sub> (Pin 16) Supply Current (Diversity Path)		V <sub>CC</sub> = 5.25V		109.3		mA
V <sub>CC</sub> (Pin 21) Supply Current (Main and Diversity Paths)		V <sub>CC</sub> = 5.25V		28.3		mA
V <sub>CC</sub> (Pin 30) Supply Current (Main Path)		V <sub>CC</sub> = 5.25V		109.3		mA
V <sub>CC</sub> (Pin 36) Supply Current (Main Path)		V <sub>CC</sub> = 5.25V		8.9		mA
IFM Bias Supply Current (Main Path)		Total bias feeding IFM- and IFM+ through R <sub>3</sub> , L <sub>1</sub> and L <sub>2</sub> ; V <sub>CC</sub> = 5.25V		61.6		mA
IFD Bias Supply Current (Diversity Path)		Total bias feeding IFD+ and IFD- through R <sub>6</sub> , L <sub>3</sub> and L <sub>4</sub> ; V <sub>CC</sub> = 5.25V		61.6		mA

# MAX19997A

## Dual, SiGe High-Linearity, 1800MHz to 2900MHz Downconversion Mixer with LO Buffer

### +3.3V SUPPLY DC ELECTRICAL CHARACTERISTICS

(Typical Application Circuit optimized for the **standard RF band (see Table 1)**, no input RF or LO signals applied,  $V_{CC} = 3.0V$  to  $3.6V$ ,  $T_C = -40^{\circ}C$  to  $+85^{\circ}C$ . Typical values are at  $V_{CC} = 3.3V$ ,  $T_C = +25^{\circ}C$ , unless otherwise noted.  $R_1, R_4 = 1.1k\Omega$ ,  $R_2, R_5 = 845\Omega$ .)

PARAMETER	SYMBOL	CONDITIONS	MIN	TYP	MAX	UNITS
Supply Voltage	$V_{CC}$		3.0	3.3	3.6	V
Supply Current	$I_{CC}$	Total supply current, $V_{CC} = 3.3V$		279	310	mA

### RECOMMENDED AC OPERATING CONDITIONS

PARAMETER	SYMBOL	CONDITIONS	MIN	TYP	MAX	UNITS
RF Frequency Without External Tuning	$f_{RF}$	(Note 5)	2400		2900	MHz
RF Frequency with External Tuning	$f_{RF}$	See Table 2 for an outline of tuning elements optimized for 1950MHz operation; optimization at other frequencies within the 1800MHz to 2400MHz range can be achieved with different component values; contact the factory for details	1800		2400	MHz
LO Frequency	$f_{LO}$	(Notes 5, 6)	1950		3400	MHz
IF Frequency	$f_{IF}$	Using Mini-Circuits TC4-1W-17 4:1 transformer as defined in the <i>Typical Application Circuit</i> , IF matching components affect the IF frequency range (Notes 5, 6)	100		550	MHz
		Using alternative Mini-Circuits TC4-1W-7A 4:1 transformer, IF matching components affect the IF frequency range (Notes 5, 6)	50		250	
LO Drive Level	$P_{LO}$		-3		+3	dBm

### +5.0V SUPPLY, HIGH-SIDE LO INJECTION AC ELECTRICAL CHARACTERISTICS

(Typical Application Circuit optimized for the **standard RF band (see Table 1)**,  $V_{CC} = 4.75V$  to  $5.25V$ , RF and LO ports are driven from  $50\Omega$  sources,  $P_{LO} = -3dBm$  to  $+3dBm$ ,  $P_{RF} = -5dBm$ ,  $f_{RF} = 2300MHz$  to  $2900MHz$ ,  $f_{LO} = 2650MHz$  to  $3250MHz$ ,  $f_{IF} = 350MHz$ ,  $f_{RF} < f_{LO}$ ,  $T_C = -40^{\circ}C$  to  $+85^{\circ}C$ . Typical values are at  $V_{CC} = 5.0V$ ,  $P_{RF} = -5dBm$ ,  $P_{LO} = 0dBm$ ,  $f_{RF} = 2600MHz$ ,  $f_{LO} = 2950MHz$ ,  $f_{IF} = 350MHz$ ,  $T_C = +25^{\circ}C$ , unless otherwise noted.) (Note 7)

PARAMETER	SYMBOL	CONDITIONS	MIN	TYP	MAX	UNITS
Conversion Gain	$G_C$	$f_{RF} = 2400MHz$ to $2900MHz$ , $T_C = +25^{\circ}C$ (Notes 8, 9, 10)	8.1	8.7	9.3	dB
		$T_C = +100^{\circ}C$		8.1		
Conversion Gain Flatness		$f_{RF} = 2305MHz$ to $2360MHz$		0.15		dB
		$f_{RF} = 2500MHz$ to $2570MHz$		0.15		
		$f_{RF} = 2570MHz$ to $2620MHz$		0.1		
		$f_{RF} = 2500MHz$ to $2690MHz$		0.15		
		$f_{RF} = 2700MHz$ to $2900MHz$		0.15		
Gain Variation Over Temperature	$T_{CCG}$	$f_{RF} = 2300MHz$ to $2900MHz$ , $T_C = -40^{\circ}C$ to $+100^{\circ}C$		-0.01		dB/ $^{\circ}C$

# MAX19997A

## Dual, SiGe High-Linearity, 1800MHz to 2900MHz Downconversion Mixer with LO Buffer

### +5.0V SUPPLY, HIGH-SIDE LO INJECTION AC ELECTRICAL CHARACTERISTICS (continued)

(Typical Application Circuit optimized for the **standard RF band (see Table 1)**,  $V_{CC} = 4.75V$  to  $5.25V$ , RF and LO ports are driven from  $50\Omega$  sources,  $P_{LO} = -3dBm$  to  $+3dBm$ ,  $P_{RF} = -5dBm$ ,  $f_{RF} = 2300MHz$  to  $2900MHz$ ,  $f_{LO} = 2650MHz$  to  $3250MHz$ ,  $f_{IF} = 350MHz$ ,  $f_{RF} < f_{LO}$ ,  $T_C = -40^\circ C$  to  $+85^\circ C$ . Typical values are at  $V_{CC} = 5.0V$ ,  $P_{RF} = -5dBm$ ,  $P_{LO} = 0dBm$ ,  $f_{RF} = 2600MHz$ ,  $f_{LO} = 2950MHz$ ,  $f_{IF} = 350MHz$ ,  $T_C = +25^\circ C$ , unless otherwise noted.) (Note 7)

PARAMETER	SYMBOL	CONDITIONS	MIN	TYP	MAX	UNITS
Input Compression Point	IP <sub>1dB</sub>	(Notes 8, 9, 11)	9.6	11.3		dBm
Third-Order Input Intercept Point	IIP3	$f_{RF1} - f_{RF2} = 1MHz$ , $P_{RF} = -5dBm$ per tone (Notes 8, 9)	22.0	24		dBm
		$f_{RF} = 2600MHz$ , $f_{RF1} - f_{RF2} = 1MHz$ , $P_{RF} = -5dBm$ per tone, $T_C = +25^\circ C$ (Notes 8, 9)	22.5	24		
		$P_{RF} = -5dBm$ /tone, $f_{RF1} - f_{RF2} = 1MHz$ , $T_C = +100^\circ C$		24.2		
Third-Order Input Intercept Point Variation Over Temperature		$f_{RF1} - f_{RF2} = 1MHz$ , $T_C = -40^\circ C$ to $+100^\circ C$		$\pm 0.3$		dBm
Noise Figure	NF <sub>SSB</sub>	Single sideband, no blockers present $f_{RF} = 2400MHz$ to $2900MHz$ (Notes 6, 8, 10)		10.4	12.5	dB
		Single sideband, no blockers present, $f_{RF} = 2400MHz$ to $2900MHz$ , $T_C = +25^\circ C$ (Notes 6, 8, 10)		10.4	11.4	
Noise Figure Temperature Coefficient	TC <sub>NF</sub>	Single sideband, no blockers present, $T_C = -40^\circ C$ to $+100^\circ C$		0.018		dB/ $^\circ C$
Noise Figure Under Blocking Conditions	NFB	$f_{BLOCKER} = 2412MHz$ , $P_{BLOCKER} = 8dBm$ , $f_{RF} = 2600MHz$ , $f_{LO} = 2950MHz$ , $P_{LO} = 0dBm$ , $V_{CC} = 5.0V$ , $T_C = +25^\circ C$ (Notes 8, 12)		22.5	25	dB
2LO - 2RF Spur	2 x 2	$f_{RF} = 2600MHz$ , $f_{LO} = 2950MHz$ , $P_{RF} = -10dBm$ , $f_{SPUR} = f_{LO} - 175MHz$ (Note 8)	62	69		dBc
		$P_{RF} = -10dBm$ , $T_C = +100^\circ C$		68		
		$f_{RF} = 2600MHz$ , $f_{LO} = 2950MHz$ , $P_{RF} = -5dBm$ , $f_{SPUR} = f_{LO} - 175MHz$ (Notes 8, 9)	57	64		
		$P_{RF} = -5dBm$ , $T_C = +100^\circ C$		63		
3LO - 3RF Spur	3 x 3	$f_{RF} = 2600MHz$ , $f_{LO} = 2950MHz$ , $P_{RF} = -10dBm$ , $f_{SPUR} = f_{LO} - 116.67MHz$ , $T_C = +25^\circ C$ (Note 8)	73	84		dBc
		$P_{RF} = -10dBm$ , $T_C = +100^\circ C$		85		
		$f_{RF} = 2600MHz$ , $f_{LO} = 2950MHz$ , $P_{RF} = -5dBm$ , $f_{SPUR} = f_{LO} - 116.67MHz$ , $T_C = +25^\circ C$ (Notes 8, 9)	63	74		
		$P_{RF} = -5dBm$ , $T_C = +100^\circ C$		75		
RF Input Return Loss		LO on and IF terminated into a matched impedance		14		dB

# MAX19997A

## Dual, SiGe High-Linearity, 1800MHz to 2900MHz Downconversion Mixer with LO Buffer

### +5.0V SUPPLY, HIGH-SIDE LO INJECTION AC ELECTRICAL CHARACTERISTICS (continued)

(Typical Application Circuit optimized for the **standard RF band (see Table 1)**,  $V_{CC} = 4.75V$  to  $5.25V$ , RF and LO ports are driven from  $50\Omega$  sources,  $P_{LO} = -3dBm$  to  $+3dBm$ ,  $P_{RF} = -5dBm$ ,  $f_{RF} = 2300MHz$  to  $2900MHz$ ,  $f_{LO} = 2650MHz$  to  $3250MHz$ ,  $f_{IF} = 350MHz$ ,  $f_{RF} < f_{LO}$ ,  $T_C = -40^\circ C$  to  $+85^\circ C$ . Typical values are at  $V_{CC} = 5.0V$ ,  $P_{RF} = -5dBm$ ,  $P_{LO} = 0dBm$ ,  $f_{RF} = 2600MHz$ ,  $f_{LO} = 2950MHz$ ,  $f_{IF} = 350MHz$ ,  $T_C = +25^\circ C$ , unless otherwise noted.) (Note 7)

PARAMETER	SYMBOL	CONDITIONS	MIN	TYP	MAX	UNITS
LO Input Return Loss		RF and IF terminated into a matched impedance		13		dB
IF Output Impedance	$Z_{IF}$	Nominal differential impedance at the IC's IF outputs		200		$\Omega$
IF Output Return Loss		RF terminated into $50\Omega$ , LO driven by $50\Omega$ source, IF transformed to $50\Omega$ using external components shown in the <i>Typical Application Circuit</i>		21		dB
RF-to-IF Isolation				25		dB
		$T_C = +100^\circ C$		24		
LO Leakage at RF Port		(Notes 8, 9)		-28		dBm
2LO Leakage at RF Port				-33		dBm
LO Leakage at IF Port				-18.5		dBm
		$T_C = +100^\circ C$		-17.8		
Channel Isolation		RFMAIN (RFDIV) converted power measured at IFDIV (IFMAIN) relative to IFMAIN (IFDIV), all unused ports terminated to $50\Omega$		38.5	43	dB
		$T_C = +100^\circ C$		43.4		

### +5.0V SUPPLY, LOW-SIDE LO INJECTION AC ELECTRICAL CHARACTERISTICS

(Typical Application Circuit optimized for the **standard RF band (see Table 1)**,  $V_{CC} = 4.75V$  to  $5.25V$ , RF and LO ports are driven from  $50\Omega$  sources,  $P_{LO} = -3dBm$  to  $+3dBm$ ,  $P_{RF} = -5dBm$ ,  $f_{RF} = 2300MHz$  to  $2900MHz$ ,  $f_{LO} = 1950MHz$  to  $2550MHz$ ,  $f_{IF} = 350MHz$ ,  $f_{RF} > f_{LO}$ ,  $T_C = -40^\circ C$  to  $+85^\circ C$ . Typical values are at  $V_{CC} = 5.0V$ ,  $P_{RF} = -5dBm$ ,  $P_{LO} = 0dBm$ ,  $f_{RF} = 2600MHz$ ,  $f_{LO} = 2250MHz$ ,  $f_{IF} = 350MHz$ ,  $T_C = +25^\circ C$ , unless otherwise noted.) (Note 7)

PARAMETER	SYMBOL	CONDITIONS	MIN	TYP	MAX	UNITS
Conversion Gain	$G_C$	$f_{RF} = 2400MHz$ to $2900MHz$ , $T_C = +25^\circ C$ (Notes 8, 9, 10)	8.1	8.7	9.3	dB
Conversion Gain Flatness		$f_{RF} = 2305MHz$ to $2360MHz$		0.2		dB
		$f_{RF} = 2500MHz$ to $2570MHz$		0.15		
		$f_{RF} = 2570MHz$ to $2620MHz$		0.2		
		$f_{RF} = 2500MHz$ to $2690MHz$		0.25		
		$f_{RF} = 2700MHz$ to $2900MHz$		0.25		
Gain Variation Over Temperature	$T_{CCG}$	$f_{RF} = 2300MHz$ to $2900MHz$ , $T_C = -40^\circ C$ to $+85^\circ C$		-0.01		dB/ $^\circ C$
Input Compression Point	$IP_{1dB}$	(Notes 6, 8, 11)	9.6	11.3		dBm

# MAX19997A

## Dual, SiGe High-Linearity, 1800MHz to 2900MHz Downconversion Mixer with LO Buffer

### +5.0V SUPPLY, LOW-SIDE LO INJECTION AC ELECTRICAL CHARACTERISTICS (continued)

(Typical Application Circuit optimized for the **standard RF band (see Table 1)**,  $V_{CC} = 4.75V$  to  $5.25V$ , RF and LO ports are driven from  $50\Omega$  sources,  $P_{LO} = -3dBm$  to  $+3dBm$ ,  $P_{RF} = -5dBm$ ,  $f_{RF} = 2300MHz$  to  $2900MHz$ ,  $f_{LO} = 1950MHz$  to  $2550MHz$ ,  $f_{IF} = 350MHz$ ,  $f_{RF} > f_{LO}$ ,  $T_C = -40^\circ C$  to  $+85^\circ C$ . Typical values are at  $V_{CC} = 5.0V$ ,  $P_{RF} = -5dBm$ ,  $P_{LO} = 0dBm$ ,  $f_{RF} = 2600MHz$ ,  $f_{LO} = 2250MHz$ ,  $f_{IF} = 350MHz$ ,  $T_C = +25^\circ C$ , unless otherwise noted.) (Note 7)

PARAMETER	SYMBOL	CONDITIONS	MIN	TYP	MAX	UNITS
Third-Order Input Intercept Point	IIP3	$f_{RF1} - f_{RF2} = 1MHz$ , $P_{RF} = -5dBm$ per tone (Notes 8, 9)	21.6	23		dBm
		$f_{RF} = 2600MHz$ , $f_{RF1} - f_{RF2} = 1MHz$ , $P_{RF} = -5dBm$ per tone, $T_C = +25^\circ C$ (Notes 8, 9)	22	23.8		dBm
Third-Order Input Intercept Point Variation Over Temperature		$f_{RF1} - f_{RF2} = 1MHz$ , $T_C = -40^\circ C$ to $+85^\circ C$		$\pm 0.3$		dBm
Noise Figure	NFSSB	Single sideband, no blockers present $f_{RF} = 2400MHz$ to $2900MHz$ (Notes 6, 8)		10.3	13.0	dB
		Single sideband, no blockers present, $f_{RF} = 2400MHz$ to $2900MHz$ , $T_C = +25^\circ C$ (Notes 6, 8)		10.3	11.3	
Noise Figure Temperature Coefficient	TCNF	Single sideband, no blockers present, $T_C = -40^\circ C$ to $+85^\circ C$		0.018		dB/ $^\circ C$
Noise Figure Under Blocking Conditions	NFB	$f_{BLOCKER} = 2793MHz$ , $P_{BLOCKER} = 8dBm$ , $f_{RF} = 2600MHz$ , $f_{LO} = 2250MHz$ , $P_{LO} = 0dBm$ , $V_{CC} = 5.0V$ , $T_C = +25^\circ C$ (Notes 6, 8, 12)		22	25	dB
2RF - 2LO Spur	2 x 2	$f_{RF} = 2600MHz$ , $f_{LO} = 2250MHz$ , $P_{RF} = -10dBm$ , $f_{SPUR} = f_{LO} + 175MHz$ , $T_C = +25^\circ C$ (Note 8)	62	67		dBc
		$f_{RF} = 2600MHz$ , $f_{LO} = 2250MHz$ , $P_{RF} = -5dBm$ , $f_{SPUR} = f_{LO} + 175MHz$ , $T_C = +25^\circ C$ (Notes 8, 9)	57	62		
3RF - 3LO Spur	3 x 3	$f_{RF} = 2600MHz$ , $f_{LO} = 2250MHz$ , $P_{RF} = -10dBm$ , $f_{SPUR} = f_{LO} + 116.67MHz$ , $T_C = +25^\circ C$ (Note 8)	78	83		dBc
		$f_{RF} = 2600MHz$ , $f_{LO} = 2250MHz$ , $P_{RF} = -5dBm$ , $f_{SPUR} = f_{LO} + 116.67MHz$ , $T_C = +25^\circ C$ (Notes 8, 9)	68	73		
RF Input Return Loss		LO on and IF terminated into a matched impedance		16		dB
LO Input Return Loss		RF and IF terminated into a matched impedance		11.5		dB

# MAX19997A

## Dual, SiGe High-Linearity, 1800MHz to 2900MHz Downconversion Mixer with LO Buffer

### +5.0V SUPPLY, LOW-SIDE LO INJECTION AC ELECTRICAL CHARACTERISTICS (continued)

(Typical Application Circuit optimized for the **standard RF band (see Table 1)**,  $V_{CC} = 4.75V$  to  $5.25V$ , RF and LO ports are driven from  $50\Omega$  sources,  $P_{LO} = -3dBm$  to  $+3dBm$ ,  $P_{RF} = -5dBm$ ,  $f_{RF} = 2300MHz$  to  $2900MHz$ ,  $f_{LO} = 1950MHz$  to  $2550MHz$ ,  $f_{IF} = 350MHz$ ,  $f_{RF} > f_{LO}$ ,  $T_C = -40^\circ C$  to  $+85^\circ C$ . Typical values are at  $V_{CC} = 5.0V$ ,  $P_{RF} = -5dBm$ ,  $P_{LO} = 0dBm$ ,  $f_{RF} = 2600MHz$ ,  $f_{LO} = 2250MHz$ ,  $f_{IF} = 350MHz$ ,  $T_C = +25^\circ C$ , unless otherwise noted.) (Note 7)

PARAMETER	SYMBOL	CONDITIONS	MIN	TYP	MAX	UNITS
IF Output Impedance	$Z_{IF}$	Nominal differential impedance at the IC's IF outputs		200		$\Omega$
IF Output Return Loss		RF terminated into $50\Omega$ , LO driven by $50\Omega$ source, IF transformed to $50\Omega$ using external components shown in the <i>Typical Application Circuit</i>		20		dB
RF-to-IF Isolation				23.5		dB
LO Leakage at RF Port		(Notes 8, 9)		-31	-24	dBm
2LO Leakage at RF Port				-27		dBm
LO Leakage at IF Port				-9.6		dBm
Channel Isolation		RFMAIN (RFDIV) converted power measured at IFDIV (IFMAIN) relative to IFMAIN (IFDIV), all unused ports terminated to $50\Omega$ (Notes 8, 9)	38.5	42		dB

### +3.3V SUPPLY, LOW-SIDE LO INJECTION AC ELECTRICAL CHARACTERISTICS

(Typical Application Circuit optimized for the **standard RF band (see Table 1)**. Typical values are at  $V_{CC} = 3.3V$ ,  $P_{RF} = -5dBm$ ,  $P_{LO} = 0dBm$ ,  $f_{RF} = 2600MHz$ ,  $f_{LO} = 2250MHz$ ,  $f_{IF} = 350MHz$ ,  $T_C = +25^\circ C$ , unless otherwise noted.) (Note 7)

PARAMETER	SYMBOL	CONDITIONS	MIN	TYP	MAX	UNITS
Conversion Gain	$G_C$	(Note 9)		8.5		dB
Conversion Gain Flatness		$f_{RF} = 2305MHz$ to $2360MHz$		0.2		dB
		$f_{RF} = 2500MHz$ to $2570MHz$		0.15		
		$f_{RF} = 2570MHz$ to $2620MHz$		0.15		
		$f_{RF} = 2500MHz$ to $2690MHz$		0.25		
		$f_{RF} = 2700MHz$ to $2900MHz$		0.15		
Gain Variation Over Temperature	$T_{CCG}$	$f_{RF} = 2300MHz$ to $2900MHz$ , $T_C = -40^\circ C$ to $+85^\circ C$		-0.01		dB/ $^\circ C$
Input Compression Point	$IP_{1dB}$			7.7		dBm
Third-Order Input Intercept Point	IIP3	$f_{RF1} - f_{RF2} = 1MHz$ , $P_{RF} = -5dBm$ per tone		19.7		dBm
Third-Order Input Intercept Variation Over Temperature		$f_{RF1} - f_{RF2} = 1MHz$ , $T_C = -40^\circ C$ to $+85^\circ C$		$\pm 0.5$		dBm
Noise Figure	$NF_{SSB}$	Single sideband, no blockers present		9.7		dB
Noise Figure Temperature Coefficient	$T_{CNF}$	Single sideband, no blockers present, $T_C = -40^\circ C$ to $+85^\circ C$		0.018		dB/ $^\circ C$

# MAX19997A

## Dual, SiGe High-Linearity, 1800MHz to 2900MHz Downconversion Mixer with LO Buffer

### +3.3V SUPPLY, LOW-SIDE LO INJECTION AC ELECTRICAL CHARACTERISTICS (continued)

(Typical Application Circuit optimized for the **standard RF band (see Table 1)**. Typical values are at  $V_{CC} = 3.3V$ ,  $P_{RF} = -5dBm$ ,  $P_{LO} = 0dBm$ ,  $f_{RF} = 2600MHz$ ,  $f_{LO} = 2250MHz$ ,  $f_{IF} = 350MHz$ ,  $T_C = +25^\circ C$ , unless otherwise noted.) (Note 7)

PARAMETER	SYMBOL	CONDITIONS	MIN	TYP	MAX	UNITS
2RF - 2LO Spur	2 x 2	$P_{RF} = -10dBm$ , $f_{SPUR} = f_{LO} + 175MHz$		74		dBc
		$P_{RF} = -5dBm$ , $f_{SPUR} = f_{LO} + 175MHz$		69		
3RF - 3LO Spur	3 x 3	$P_{RF} = -10dBm$ , $f_{SPUR} = f_{LO} + 116.67MHz$		74		dBc
		$P_{RF} = -5dBm$ , $f_{SPUR} = f_{LO} + 116.67MHz$		64		
RF Input Return Loss		LO on and IF terminated into a matched impedance		16		dB
LO Input Return Loss		RF and IF terminated into a matched impedance		11		dB
IF Output Impedance	$Z_{IF}$	Nominal differential impedance at the IC's IF outputs		200		$\Omega$
IF Output Return Loss		RF terminated into $50\Omega$ , LO driven by $50\Omega$ source, IF transformed to $50\Omega$ using external components shown in the <i>Typical Application Circuit</i>		26		dB
RF-to-IF Isolation				25		dB
LO Leakage at RF Port				-36		dBm
2LO Leakage at RF Port				-31		dBm
LO Leakage at IF Port				-13.5		dBm
Channel Isolation		RFMAIN (RFDIV) converted power measured at IFDIV (IFMAIN) relative to IFMAIN (IFDIV), all unused ports terminated to $50\Omega$		42		dB

**Note 5:** Operation outside this range is possible, but with degraded performance of some parameters. See the *Typical Operating Characteristics*.

**Note 6:** Not production tested.

**Note 7:** All limits reflect losses of external components, including a 0.8dB loss at  $f_{IF} = 350MHz$  due to the 4:1 impedance transformer. Output measurements taken at the IF outputs of *Typical Application Circuit*.

**Note 8:** Guaranteed by design and characterization.

**Note 9:** 100% production tested for functional performance.

**Note 10:** RF frequencies below 2400MHz require external RF tuning similar to components listed in Table 2.

**Note 11:** Maximum reliable continuous input power applied to the RF or IF port of this device is +12dBm from a  $50\Omega$  source.

**Note 12:** Measured with external LO source noise filtered so the noise floor is -174dBm/Hz. This specification reflects the effects of all SNR degradations in the mixer, including the LO noise as defined in Application Note 2021: *Specifications and Measurement of Local Oscillator Noise in Integrated Circuit Base Station Mixers*.



# MAX19997A

## Dual, SiGe High-Linearity, 1800MHz to 2900MHz Downconversion Mixer with LO Buffer

### Typical Operating Characteristics

(Typical Application Circuit, standard RF band (see Table 1),  $V_{CC} = 5.0V$ , LO is high-side injected for a 350MHz IF,  $P_{LO} = 0dBm$ ,  $P_{RF} = -5dBm$ ,  $T_C = +25^\circ C$ , unless otherwise noted.)

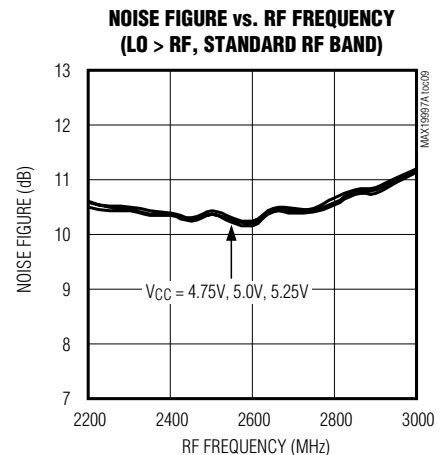
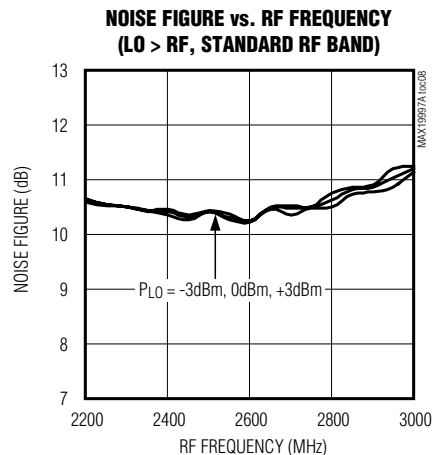
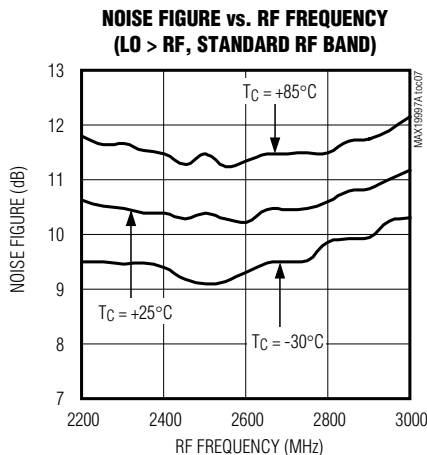
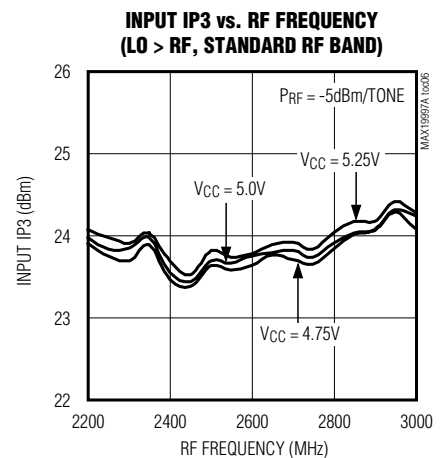
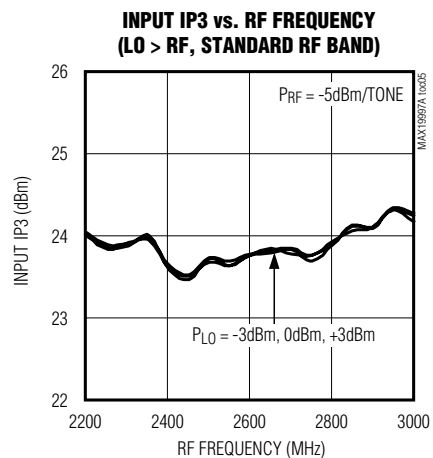
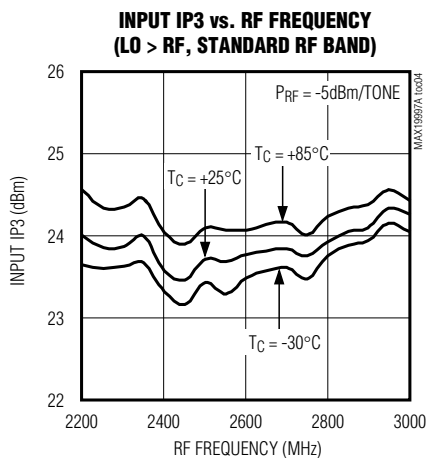
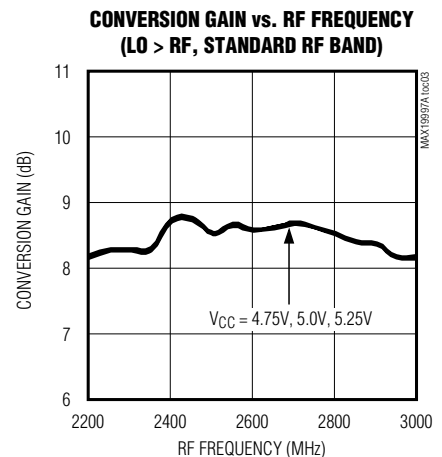
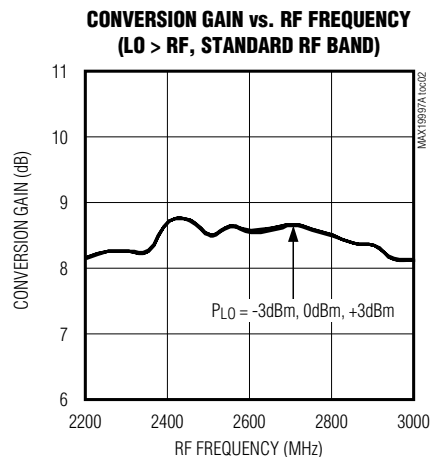
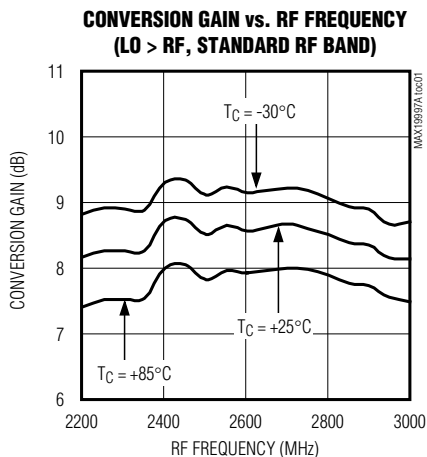

# MAX1997A

## Dual, SiGe High-Linearity, 1800MHz to 2900MHz Downconversion Mixer with LO Buffer

### Typical Operating Characteristics (continued)

(Typical Application Circuit, standard RF band (see Table 1),  $V_{CC} = 5.0V$ , LO is high-side injected for a 350MHz IF,  $P_{LO} = 0dBm$ ,  $P_{RF} = -5dBm$ ,  $T_C = +25^\circ C$ , unless otherwise noted.)

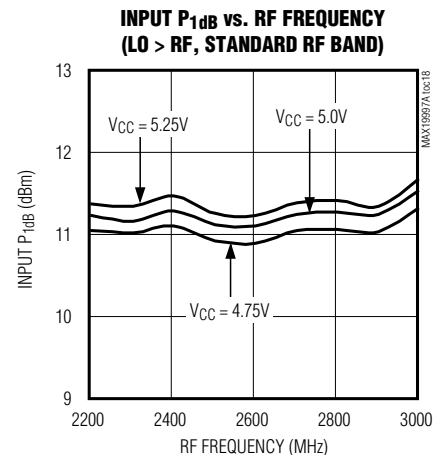
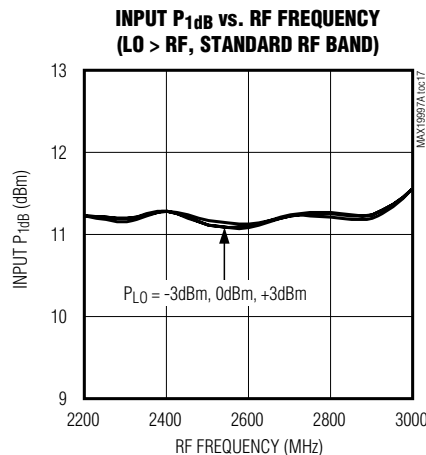
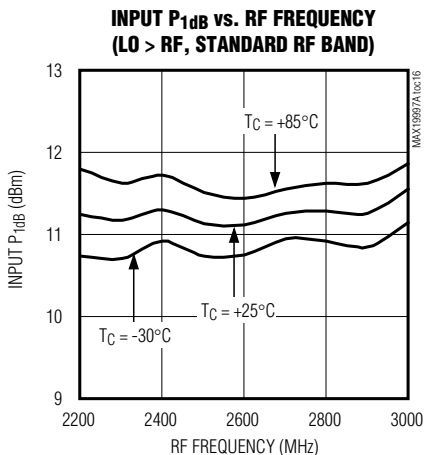
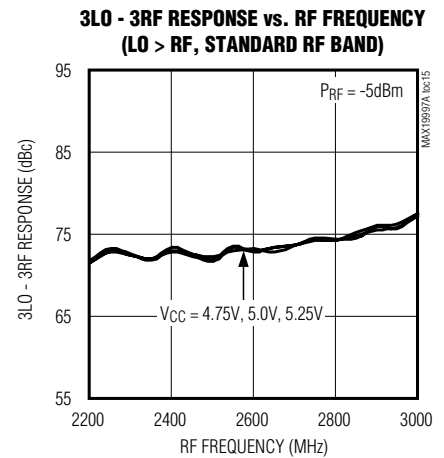
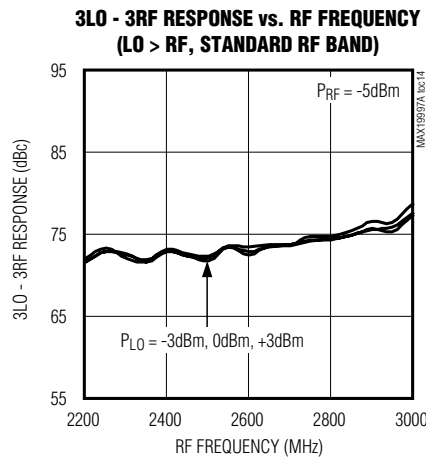
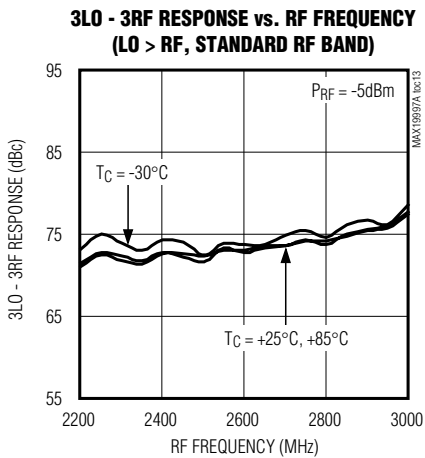
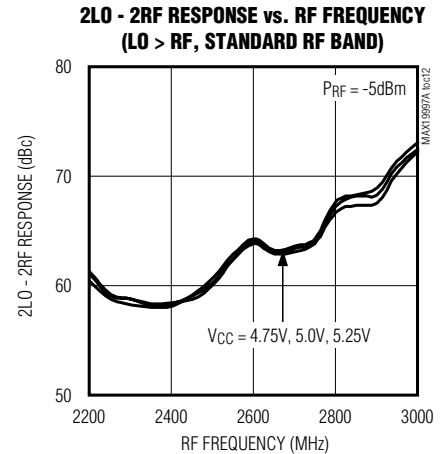
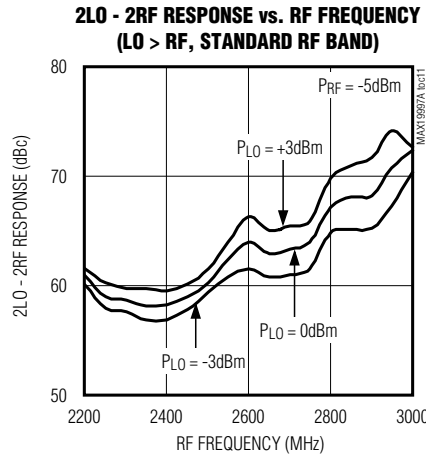
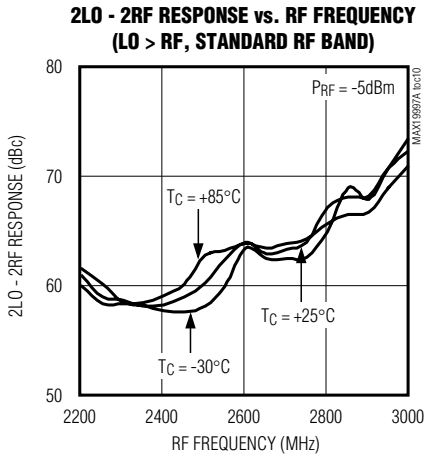

# MAX19997A

## Dual, SiGe High-Linearity, 1800MHz to 2900MHz Downconversion Mixer with LO Buffer

### Typical Operating Characteristics (continued)

(Typical Application Circuit, standard RF band (see Table 1),  $V_{CC} = 5.0V$ , LO is high-side injected for a 350MHz IF,  $P_{LO} = 0dBm$ ,  $P_{RF} = -5dBm$ ,  $T_C = +25^\circ C$ , unless otherwise noted.)

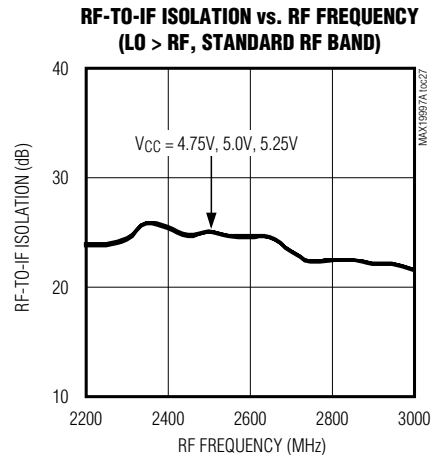
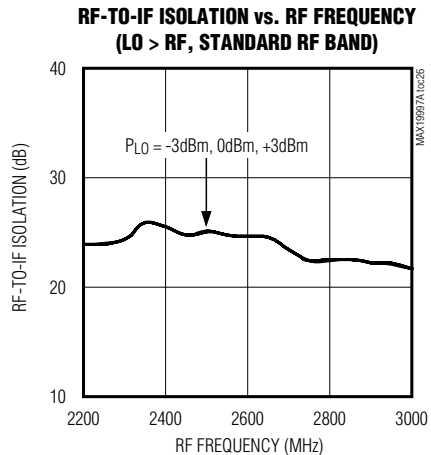
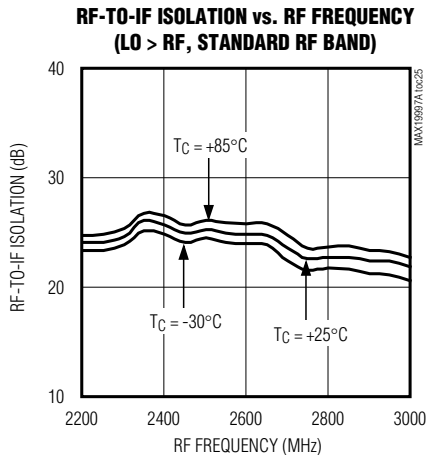
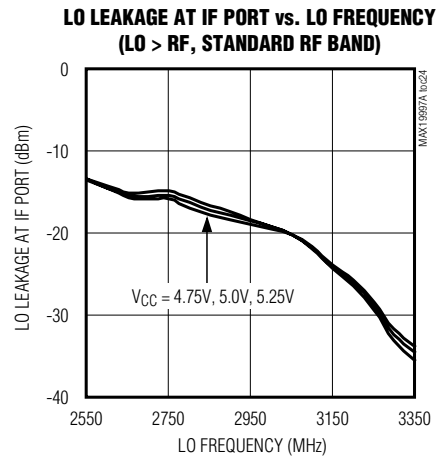
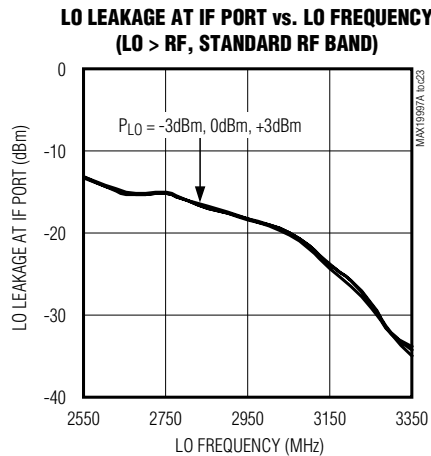
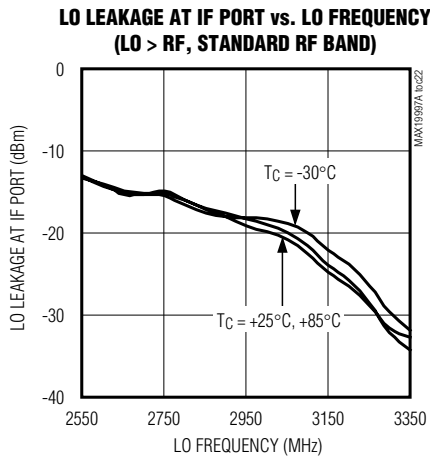
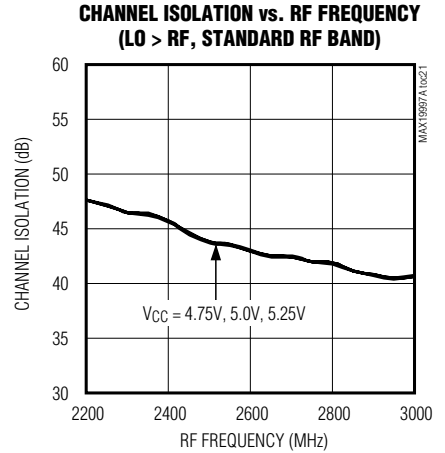
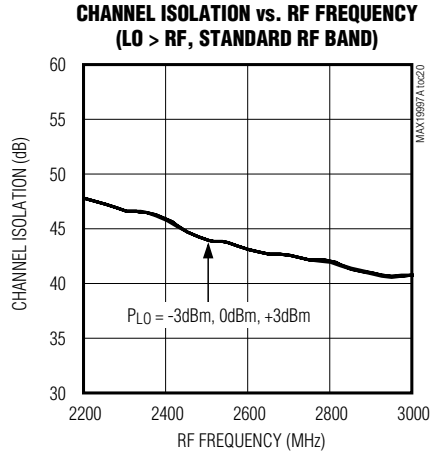
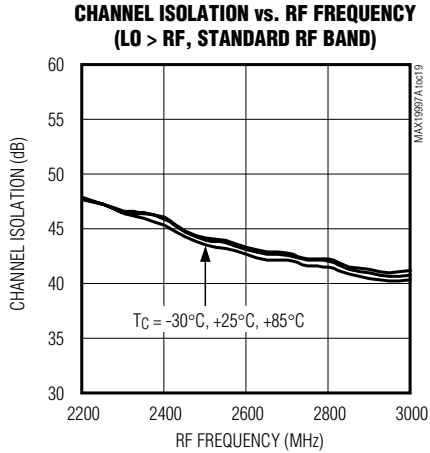

# MAX1997A

## Dual, SiGe High-Linearity, 1800MHz to 2900MHz Downconversion Mixer with LO Buffer

### Typical Operating Characteristics (continued)

(Typical Application Circuit, standard RF band (see Table 1),  $V_{CC} = 5.0V$ , LO is high-side injected for a 350MHz IF,  $P_{LO} = 0dBm$ ,  $P_{RF} = -5dBm$ ,  $T_C = +25^\circ C$ , unless otherwise noted.)

**LO LEAKAGE AT RF PORT vs. LO FREQUENCY  
(LO > RF, STANDARD RF BAND)**

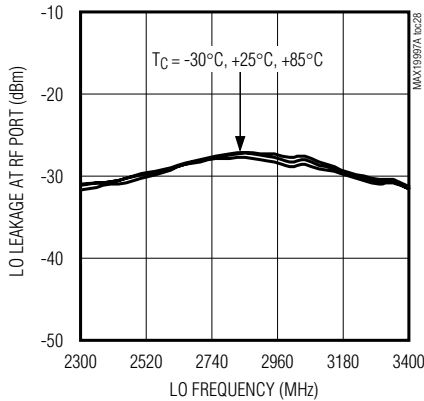

**LO LEAKAGE AT RF PORT vs. LO FREQUENCY  
(LO > RF, STANDARD RF BAND)**

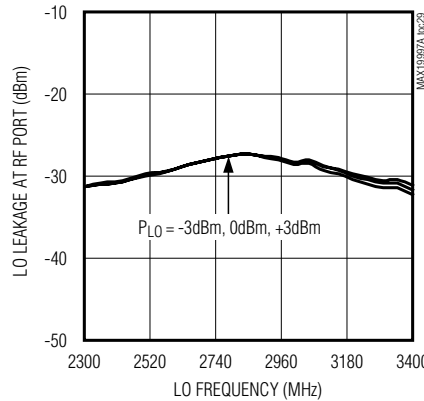

**LO LEAKAGE AT RF PORT vs. LO FREQUENCY  
(LO > RF, STANDARD RF BAND)**

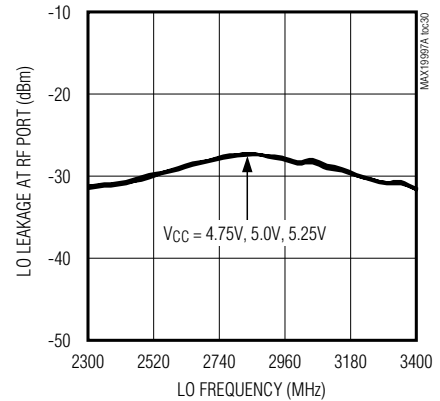

**2LO LEAKAGE AT RF PORT vs. LO FREQUENCY  
(LO > RF, STANDARD RF BAND)**

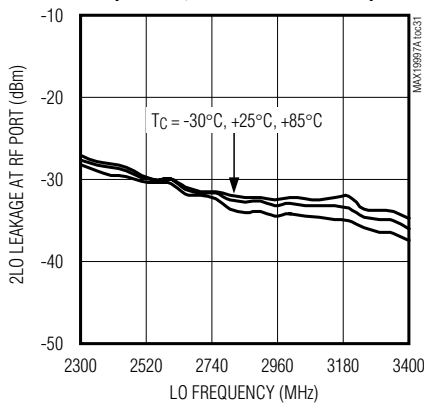

**2LO LEAKAGE AT RF PORT vs. LO FREQUENCY  
(LO > RF, STANDARD RF BAND)**

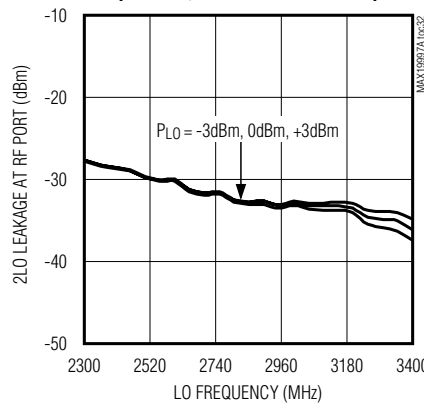

**2LO LEAKAGE AT RF PORT vs. LO FREQUENCY  
(LO > RF, STANDARD RF BAND)**

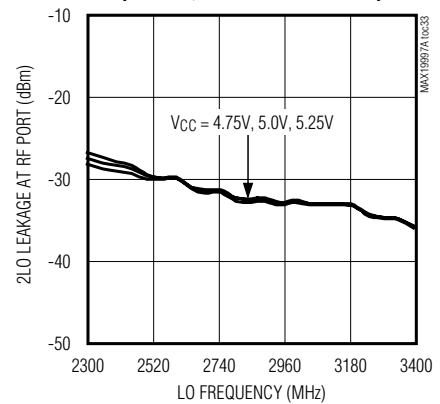

# MAX19997A

## Dual, SiGe High-Linearity, 1800MHz to 2900MHz Downconversion Mixer with LO Buffer

### Typical Operating Characteristics (continued)

(Typical Application Circuit, standard RF band (see Table 1),  $V_{CC} = 5.0V$ , LO is high-side injected for a 350MHz IF,  $P_{LO} = 0dBm$ ,  $P_{RF} = -5dBm$ ,  $T_C = +25^\circ C$ , unless otherwise noted.)

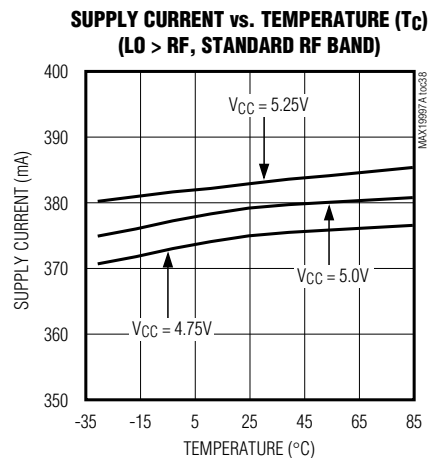
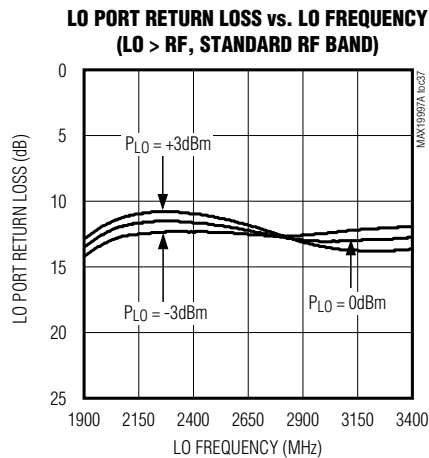
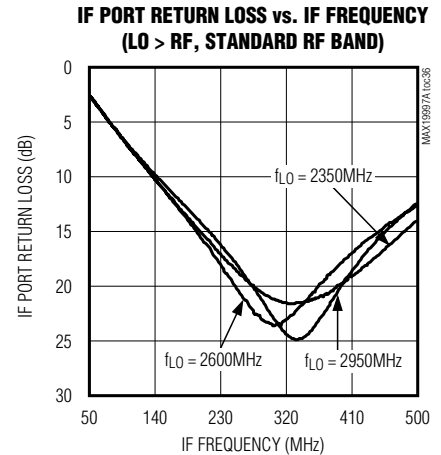
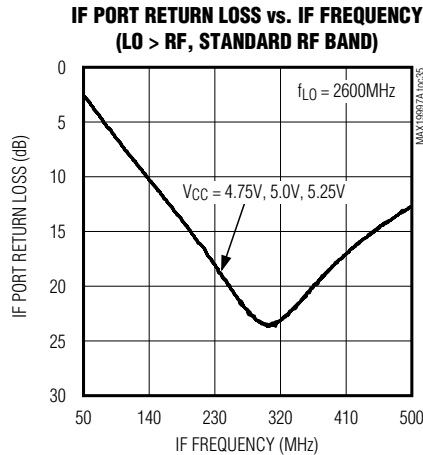
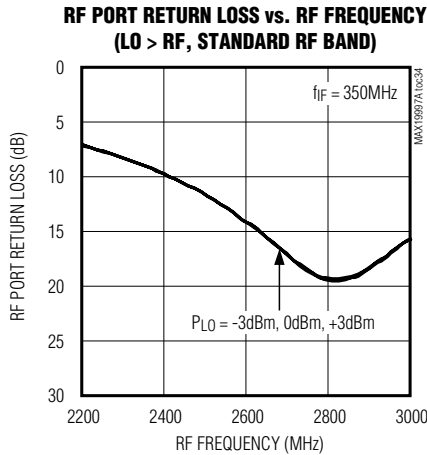

# MAX1997A

## Dual, SiGe High-Linearity, 1800MHz to 2900MHz Downconversion Mixer with LO Buffer

### Typical Operating Characteristics (continued)

(Typical Application Circuit, extended RF band (see Table 2),  $V_{CC} = 5.0V$ , LO is high-side injected for a 350MHz IF,  $P_{LO} = 0dBm$ ,  $P_{RF} = -5dBm$ ,  $T_C = +25^\circ C$ , unless otherwise noted.)

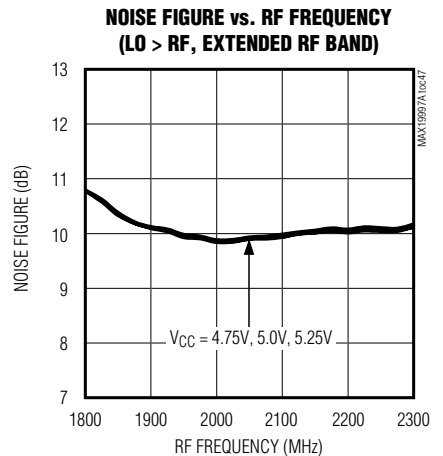
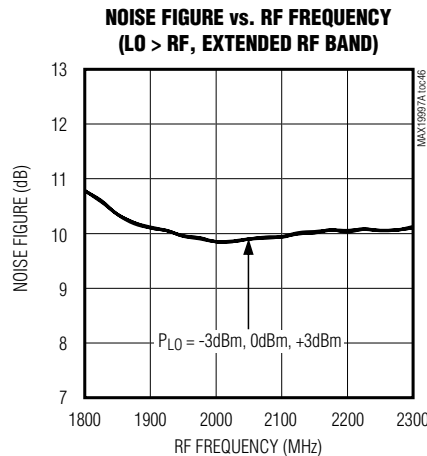
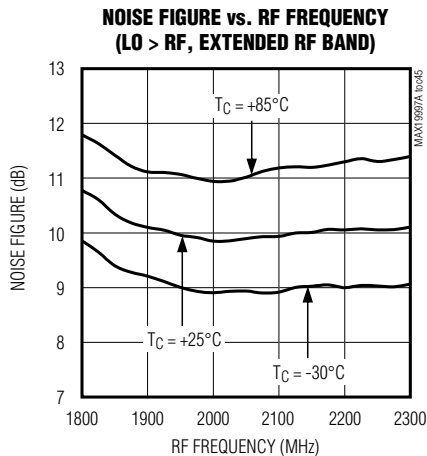
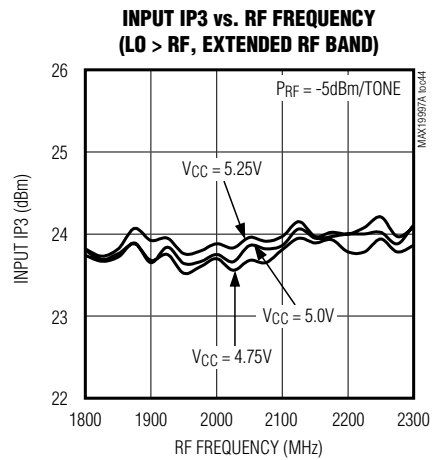
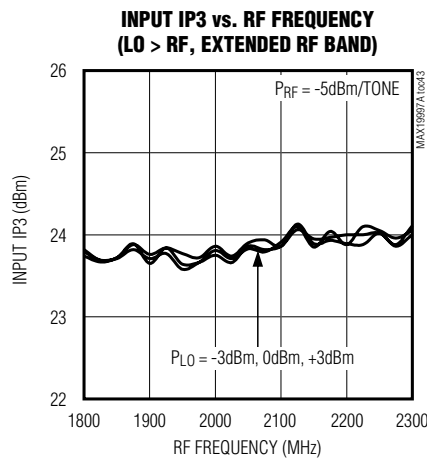
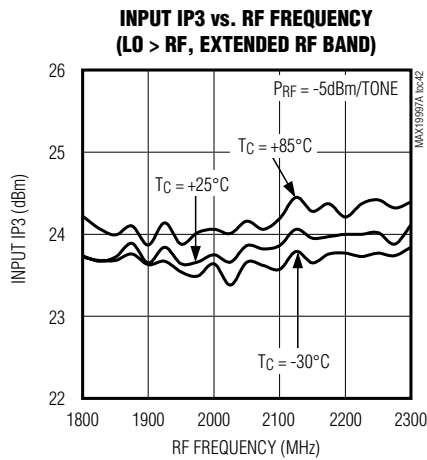
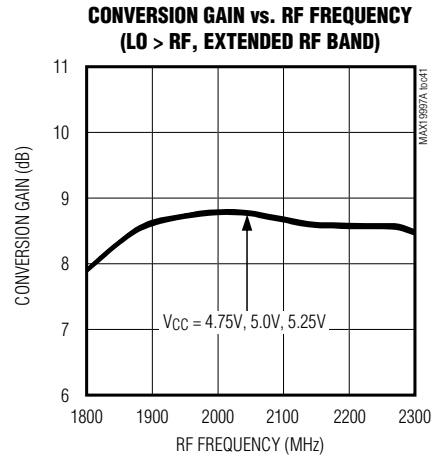
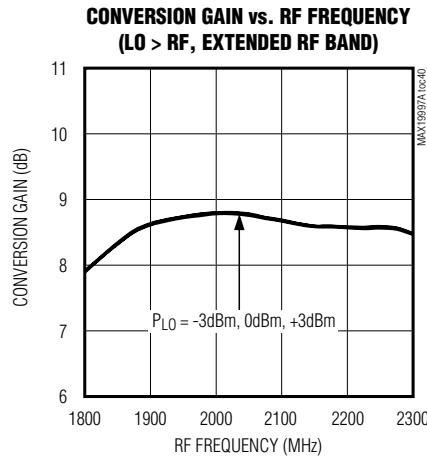
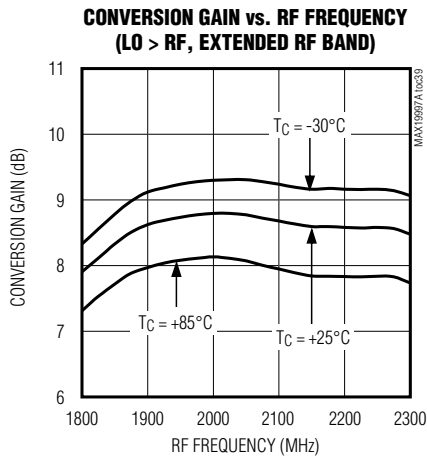

# MAX19997A

## Dual, SiGe High-Linearity, 1800MHz to 2900MHz Downconversion Mixer with LO Buffer

### Typical Operating Characteristics (continued)

(Typical Application Circuit, extended RF band (see Table 2),  $V_{CC} = 5.0V$ , LO is high-side injected for a 350MHz IF,  $P_{LO} = 0dBm$ ,  $P_{RF} = -5dBm$ ,  $T_C = +25^\circ C$ , unless otherwise noted.)

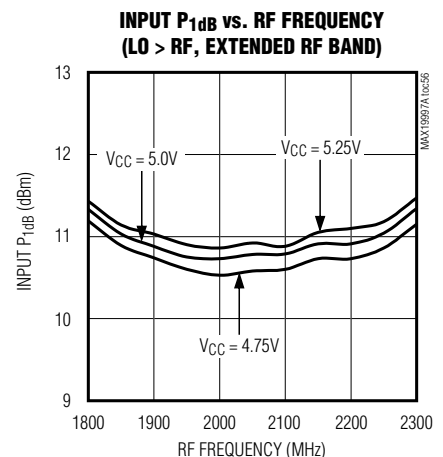
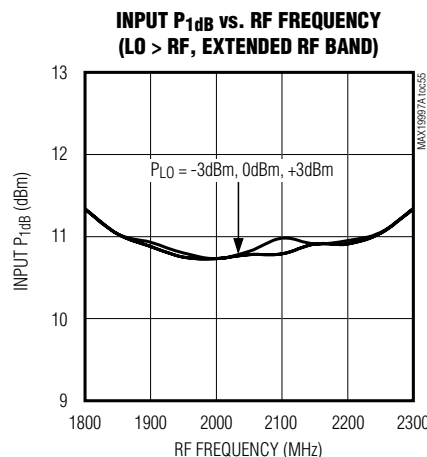
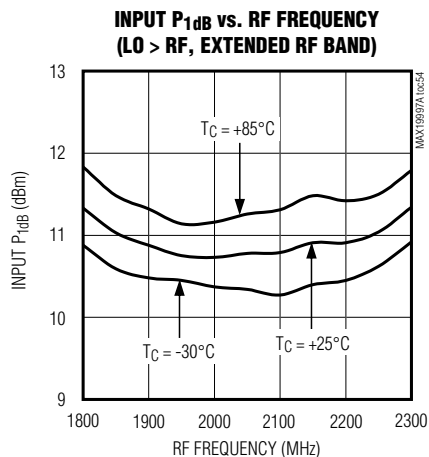
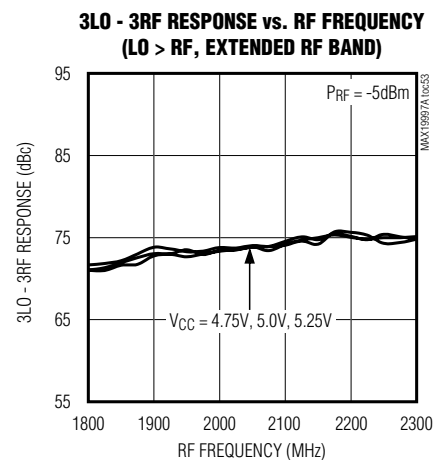
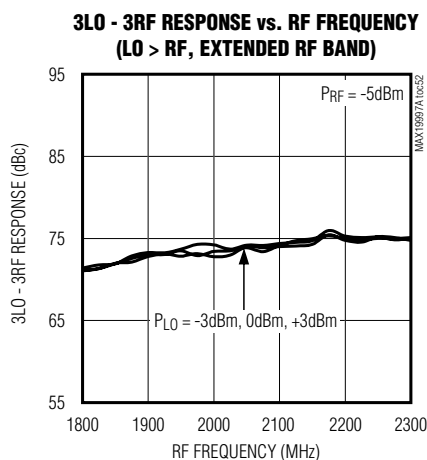
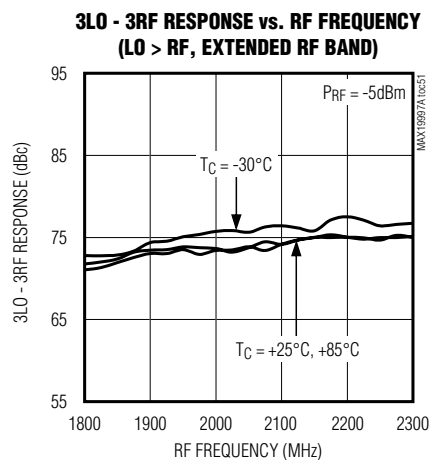
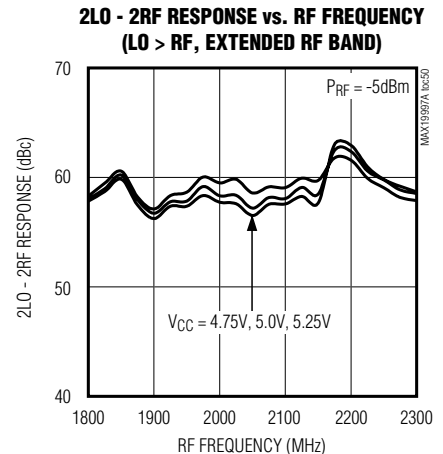
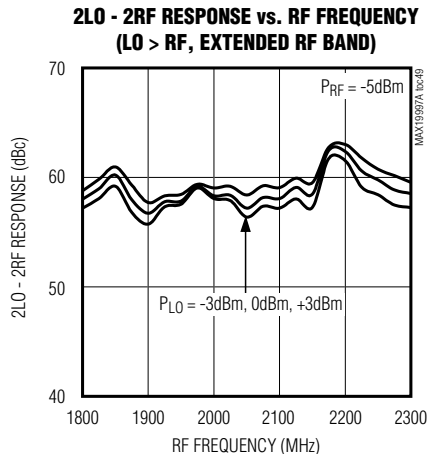
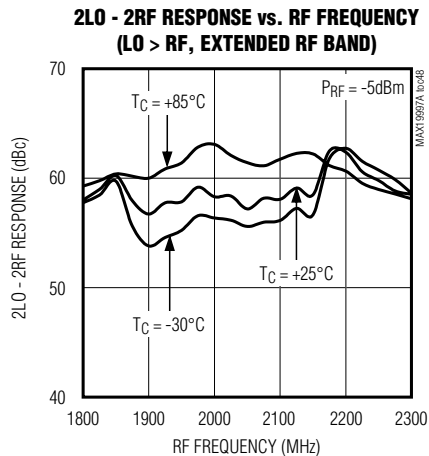

# MAX1997A

## Dual, SiGe High-Linearity, 1800MHz to 2900MHz Downconversion Mixer with LO Buffer

### Typical Operating Characteristics (continued)

(Typical Application Circuit, extended RF band (see Table 2),  $V_{CC} = 5.0V$ , LO is high-side injected for a 350MHz IF,  $P_{LO} = 0dBm$ ,  $P_{RF} = -5dBm$ ,  $T_C = +25^\circ C$ , unless otherwise noted.)

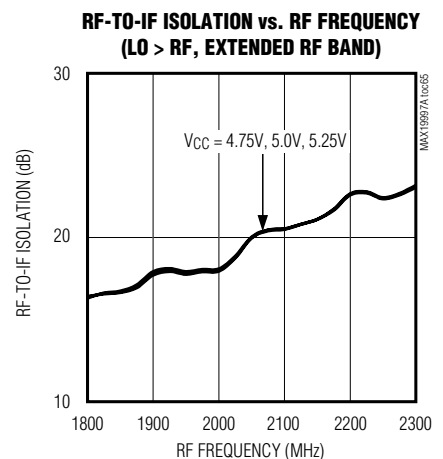
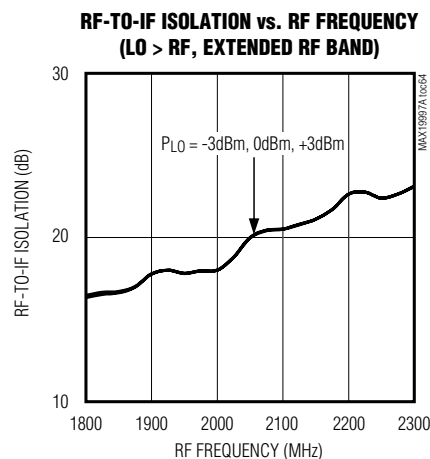
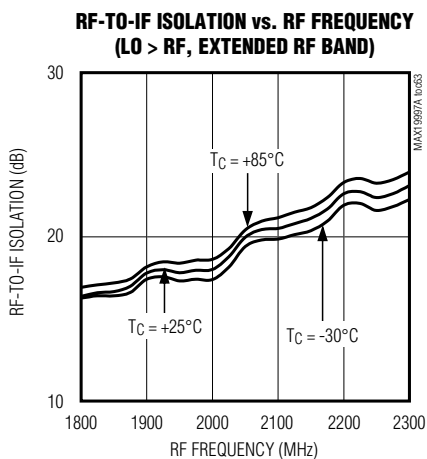
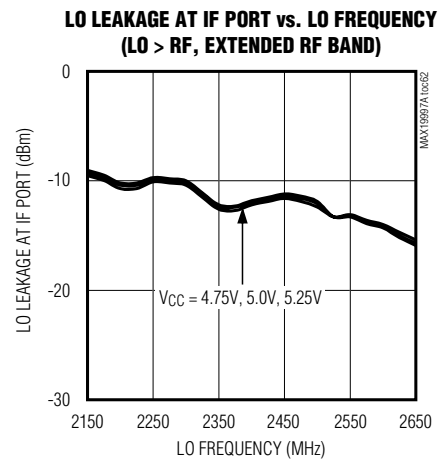
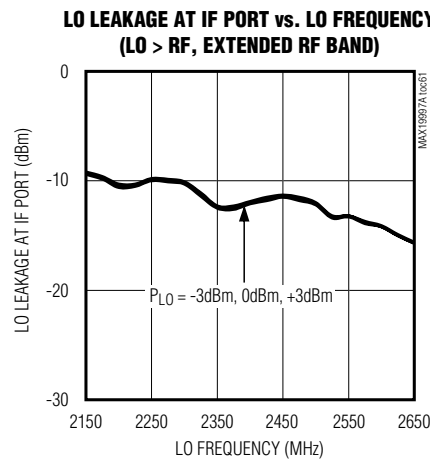
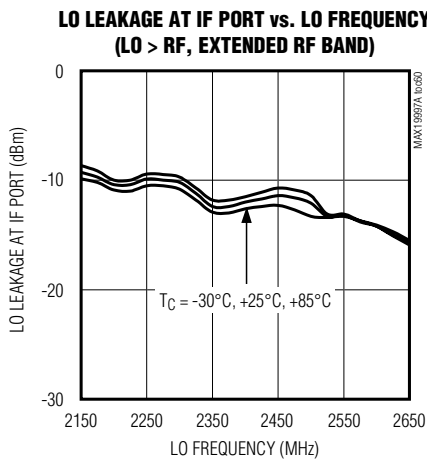
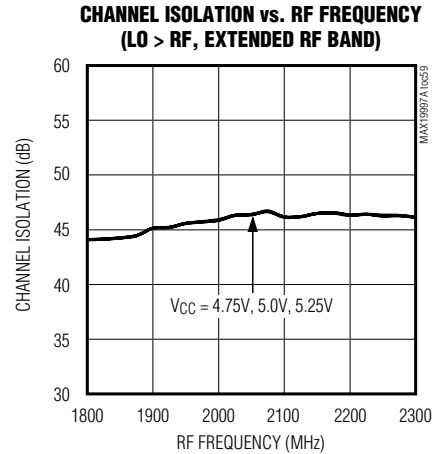
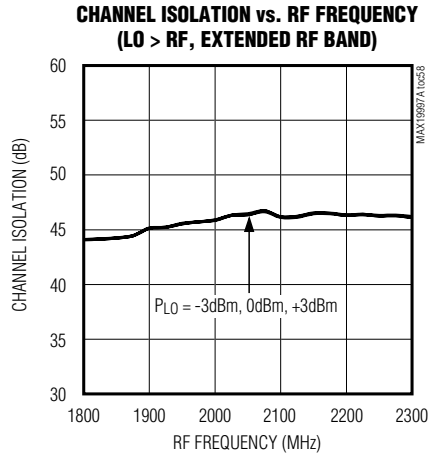
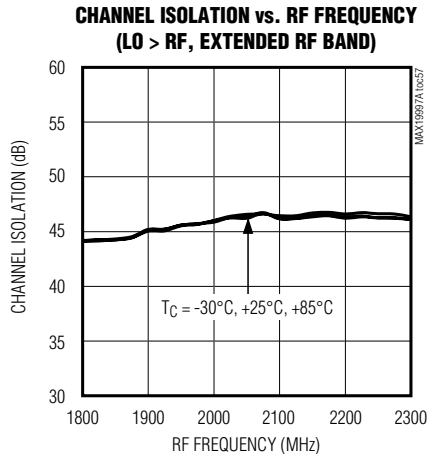



# MAX19997A

## Dual, SiGe High-Linearity, 1800MHz to 2900MHz Downconversion Mixer with LO Buffer

### Typical Operating Characteristics (continued)

(Typical Application Circuit, extended RF band (see Table 2),  $V_{CC} = 5.0V$ , LO is high-side injected for a 350MHz IF,  $P_{LO} = 0dBm$ ,  $P_{RF} = -5dBm$ ,  $T_C = +25^\circ C$ , unless otherwise noted.)

**LO LEAKAGE AT RF PORT vs. LO FREQUENCY  
(LO > RF, EXTENDED RF BAND)**

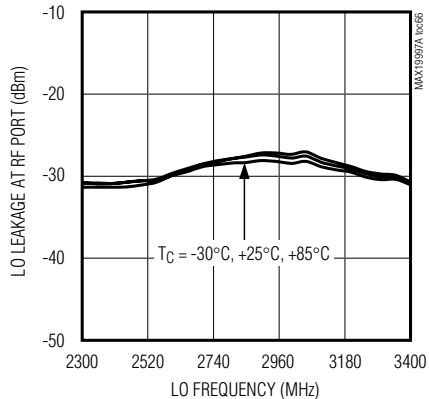

**LO LEAKAGE AT RF PORT vs. LO FREQUENCY  
(LO > RF, EXTENDED RF BAND)**

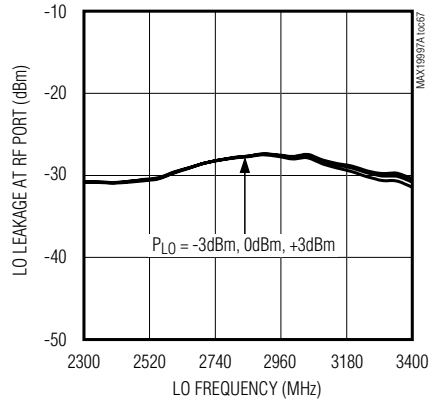

**LO LEAKAGE AT RF PORT vs. LO FREQUENCY  
(LO > RF, EXTENDED RF BAND)**

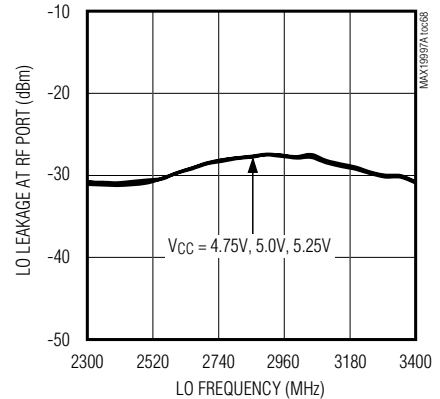

**2LO LEAKAGE AT RF PORT vs. LO FREQUENCY  
(LO > RF, EXTENDED RF BAND)**

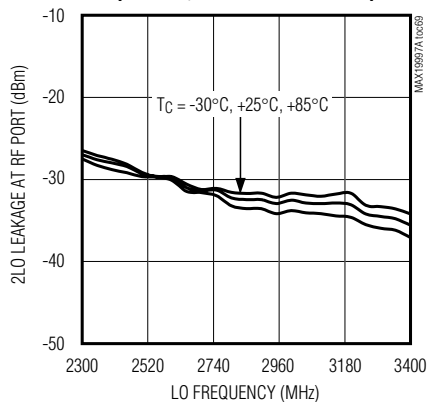

**2LO LEAKAGE AT RF PORT vs. LO FREQUENCY  
(LO > RF, EXTENDED RF BAND)**

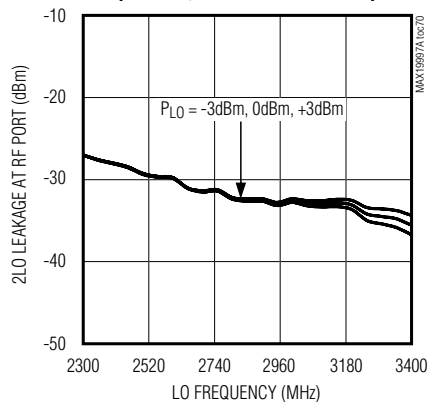

**2LO LEAKAGE AT RF PORT vs. LO FREQUENCY  
(LO > RF, EXTENDED RF BAND)**

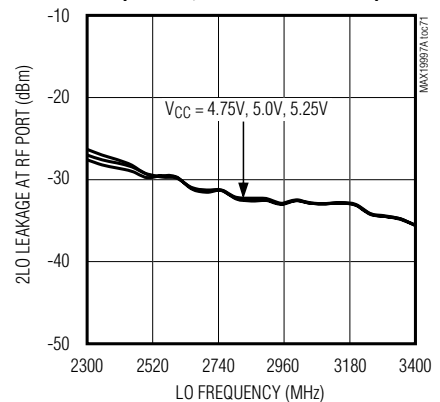

# MAX19997A

## Dual, SiGe High-Linearity, 1800MHz to 2900MHz Downconversion Mixer with LO Buffer

### Typical Operating Characteristics (continued)

(Typical Application Circuit, extended RF band (see Table 2),  $V_{CC} = 5.0V$ , LO is high-side injected for a 350MHz IF,  $P_{LO} = 0dBm$ ,  $P_{RF} = -5dBm$ ,  $T_C = +25^{\circ}C$ , unless otherwise noted.)

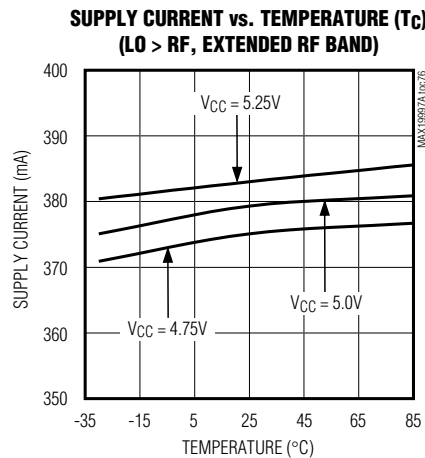
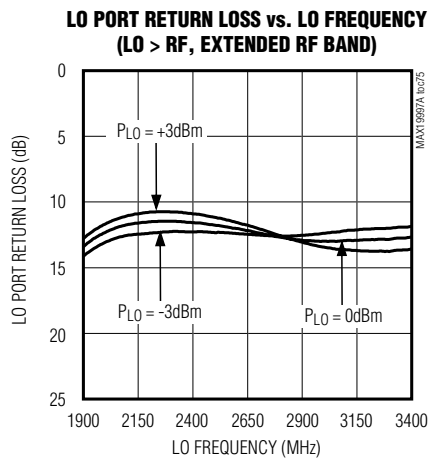
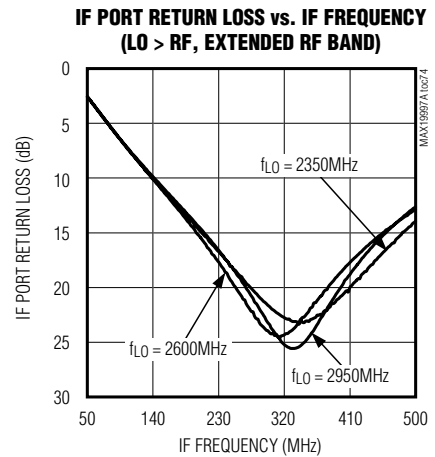
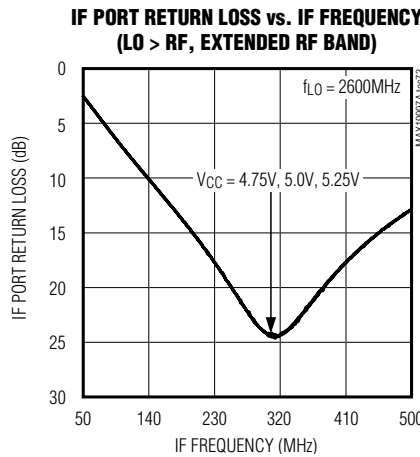
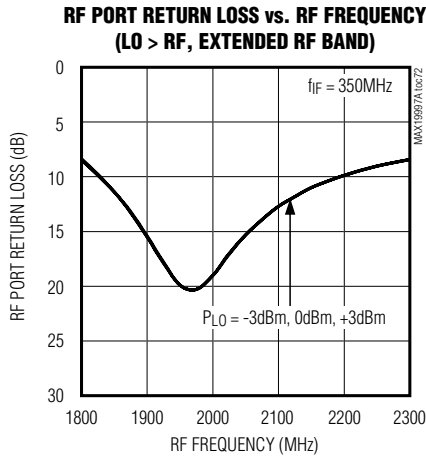

# MAX19997A

## Dual, SiGe High-Linearity, 1800MHz to 2900MHz Downconversion Mixer with LO Buffer

### Typical Operating Characteristics (continued)

(Typical Application Circuit, standard RF band (see Table 1),  $V_{CC} = 5.0V$ , LO is low-side injected for a 350MHz IF,  $P_{LO} = 0dBm$ ,  $P_{RF} = -5dBm$ ,  $T_C = +25^\circ C$ , unless otherwise noted.)

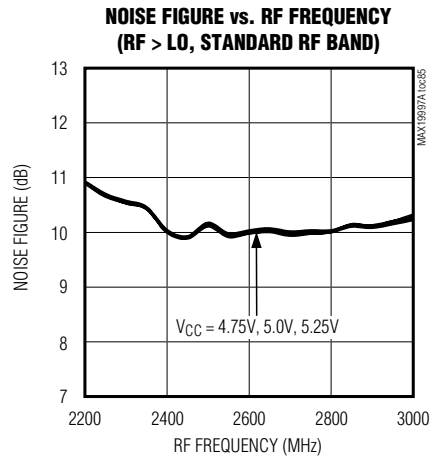
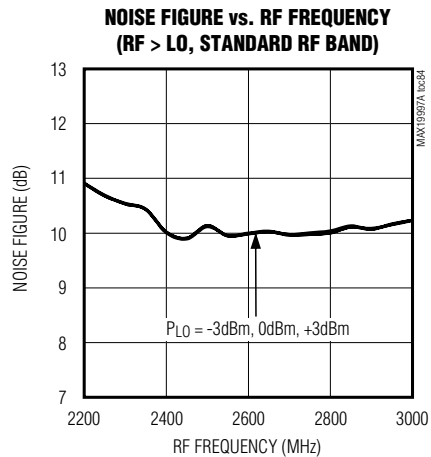
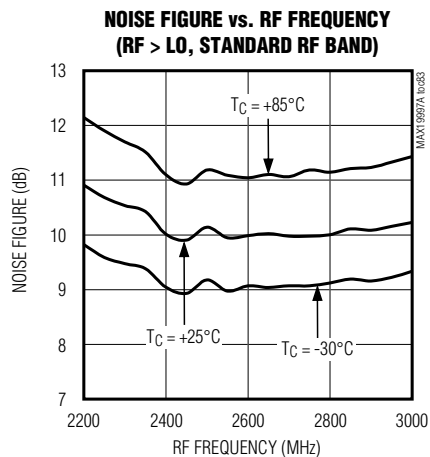
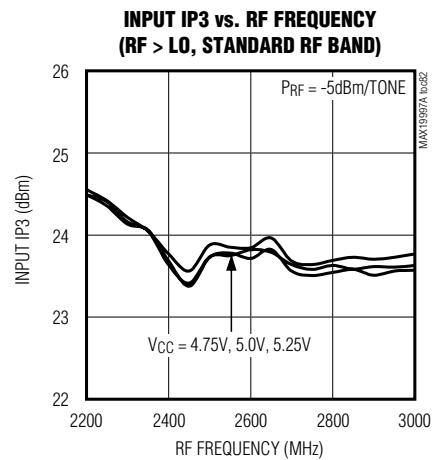
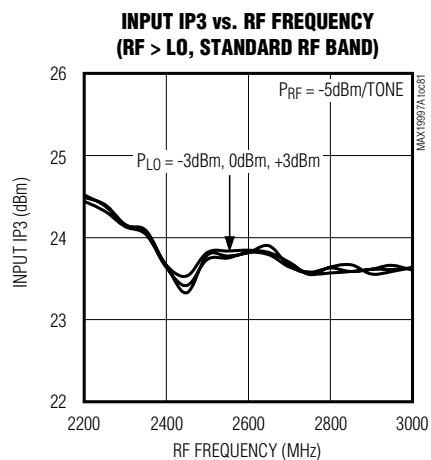
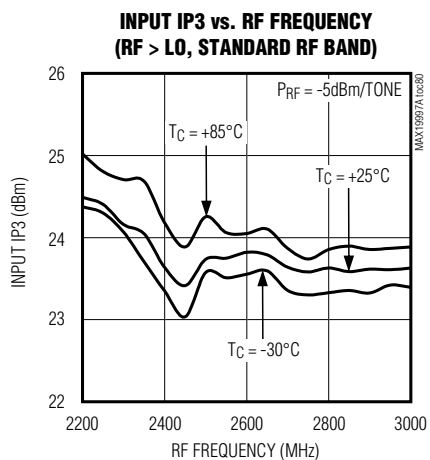
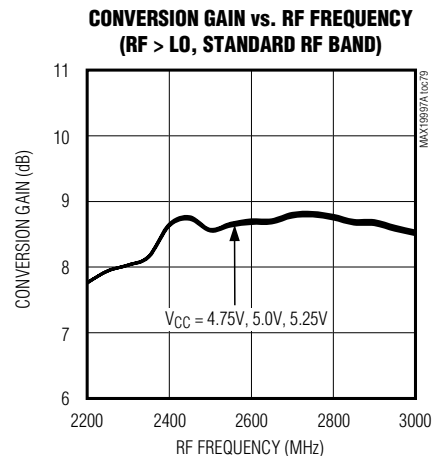
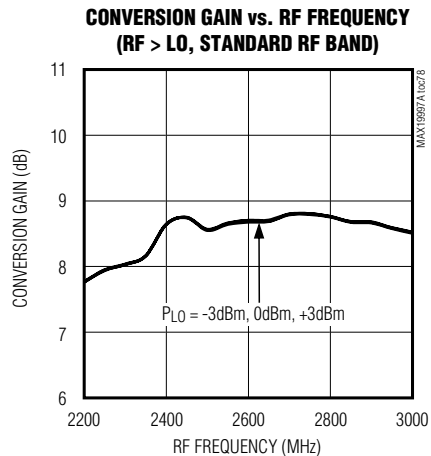
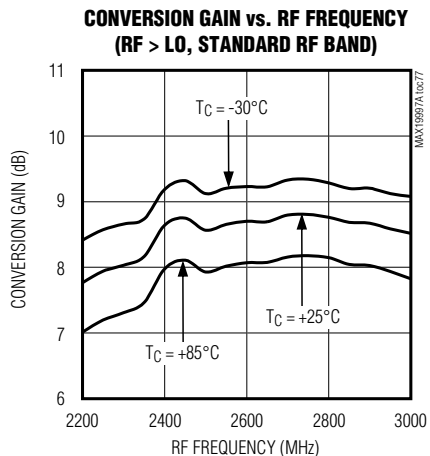

# MAX19997A

## Dual, SiGe High-Linearity, 1800MHz to 2900MHz Downconversion Mixer with LO Buffer

### Typical Operating Characteristics (continued)

(Typical Application Circuit, standard RF band (see Table 1),  $V_{CC} = 5.0V$ , LO is low-side injected for a 350MHz IF,  $P_{LO} = 0dBm$ ,  $P_{RF} = -5dBm$ ,  $T_C = +25^\circ C$ , unless otherwise noted.)

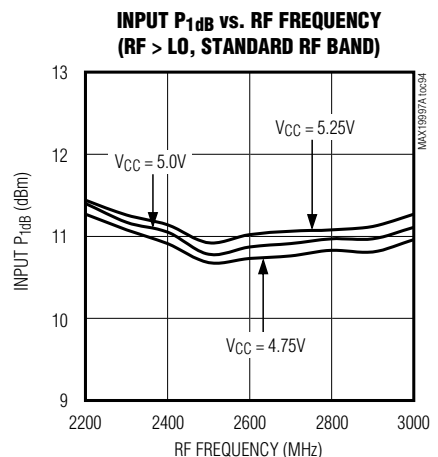
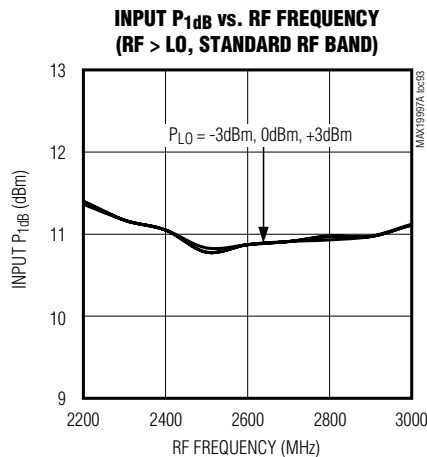
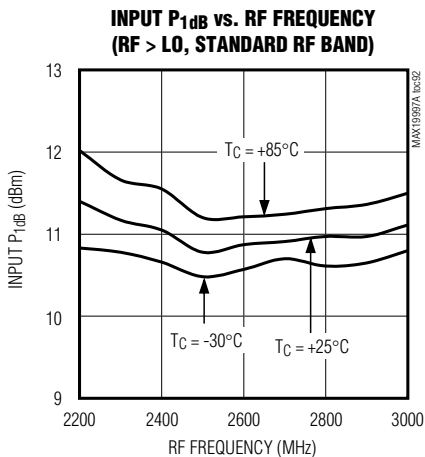
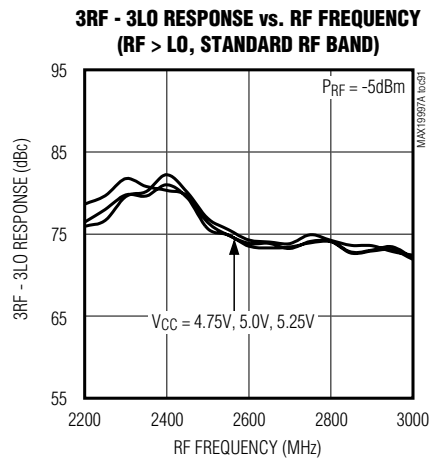
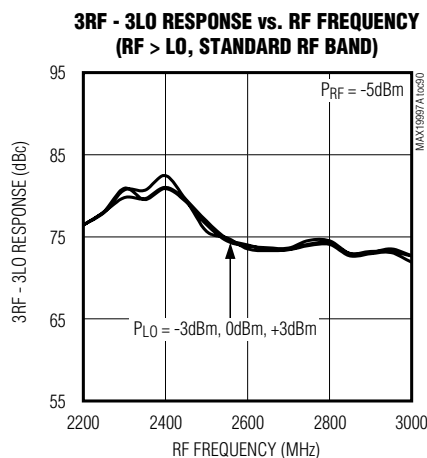
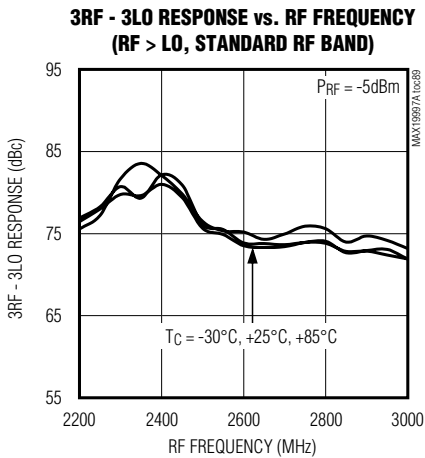
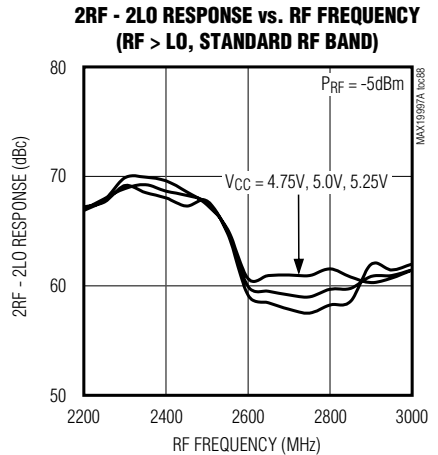
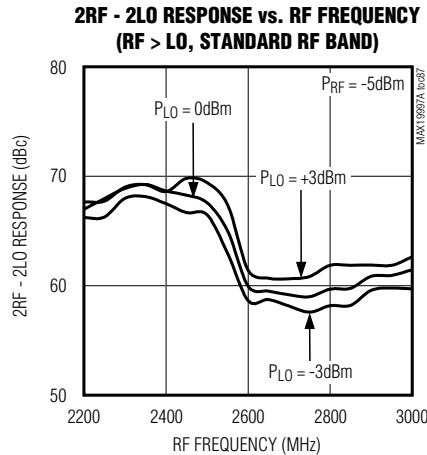
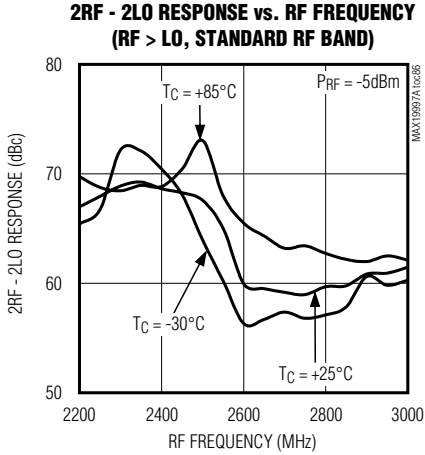

# MAX19997A

## Dual, SiGe High-Linearity, 1800MHz to 2900MHz Downconversion Mixer with LO Buffer

### Typical Operating Characteristics (continued)

(Typical Application Circuit, standard RF band (see Table 1),  $V_{CC} = 5.0V$ , LO is low-side injected for a 350MHz IF,  $P_{LO} = 0dBm$ ,  $P_{RF} = -5dBm$ ,  $T_C = +25^\circ C$ , unless otherwise noted.)

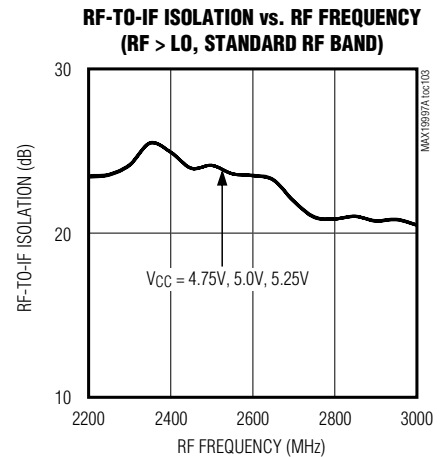
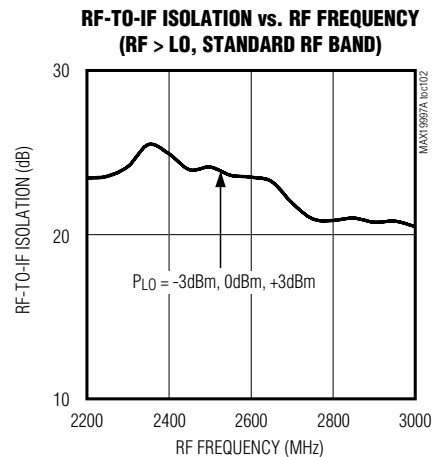
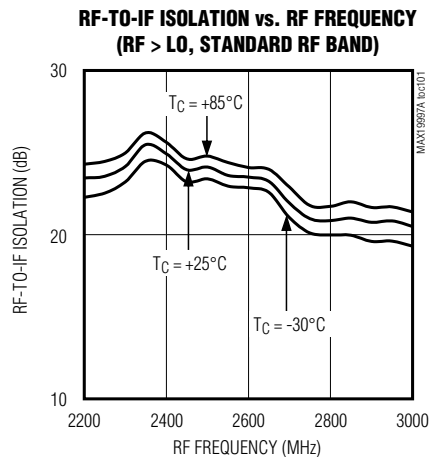
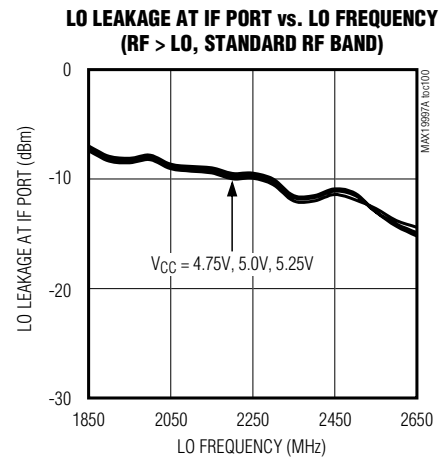
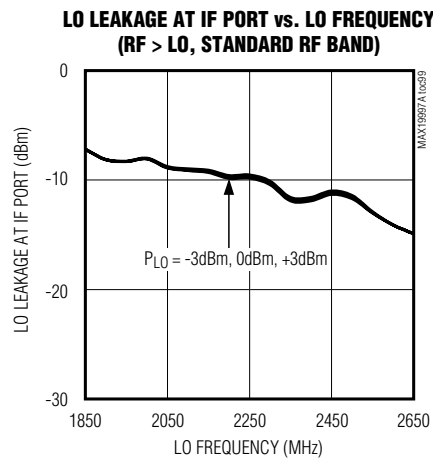
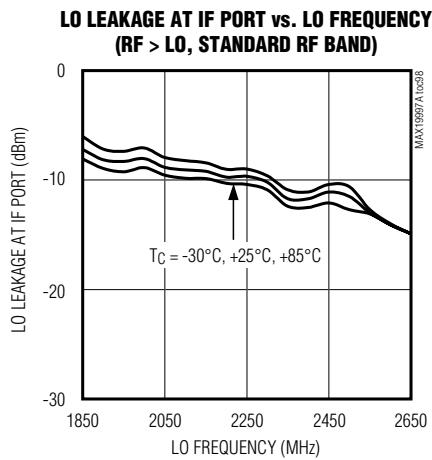
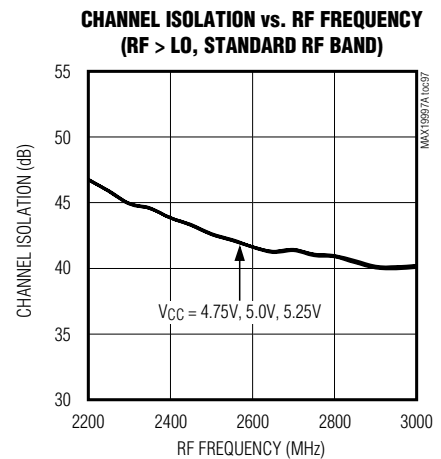
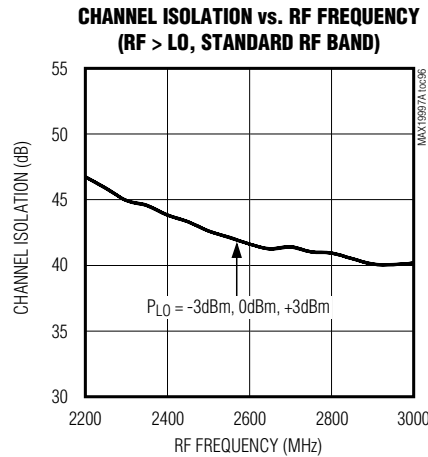
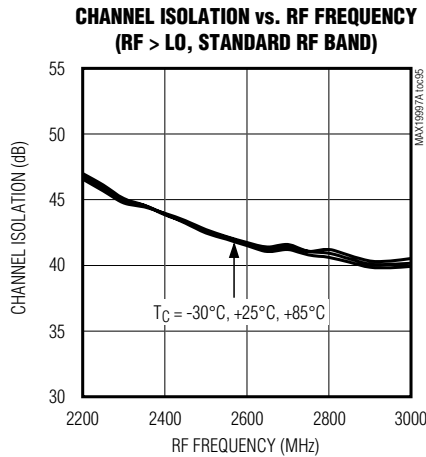

# MAX1997A

## Dual, SiGe High-Linearity, 1800MHz to 2900MHz Downconversion Mixer with LO Buffer

### Typical Operating Characteristics (continued)

(Typical Application Circuit, standard RF band (see Table 1),  $V_{CC} = 5.0V$ , LO is low-side injected for a 350MHz IF,  $P_{LO} = 0dBm$ ,  $P_{RF} = -5dBm$ ,  $T_C = +25^\circ C$ , unless otherwise noted.)

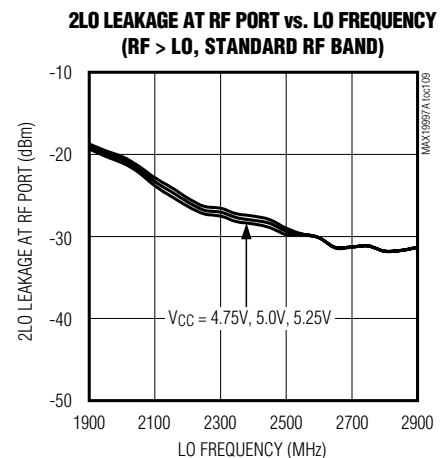
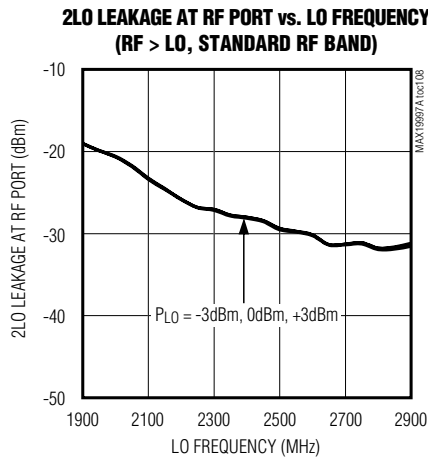
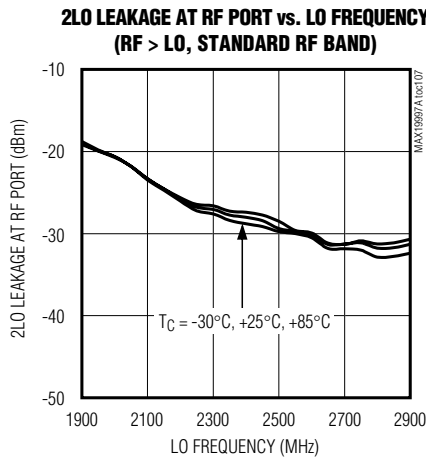
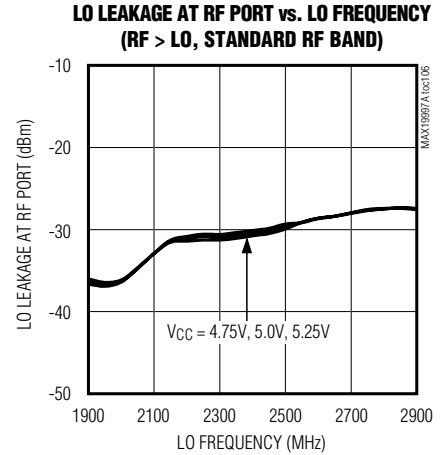
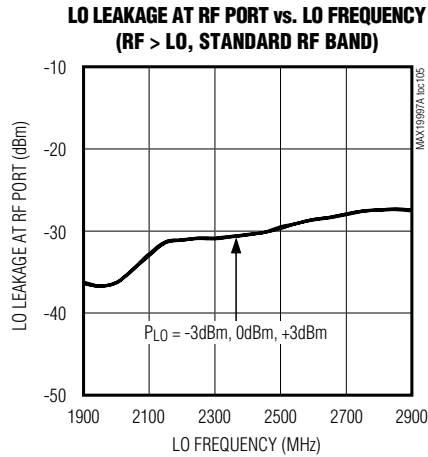
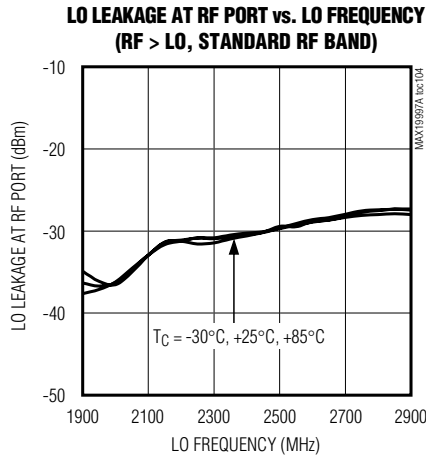

# MAX19997A

## Dual, SiGe High-Linearity, 1800MHz to 2900MHz Downconversion Mixer with LO Buffer

### Typical Operating Characteristics (continued)

(Typical Application Circuit, standard RF band (see Table 1),  $V_{CC} = 5.0V$ , LO is low-side injected for a 350MHz IF,  $P_{LO} = 0dBm$ ,  $P_{RF} = -5dBm$ ,  $T_C = +25^\circ C$ , unless otherwise noted.)

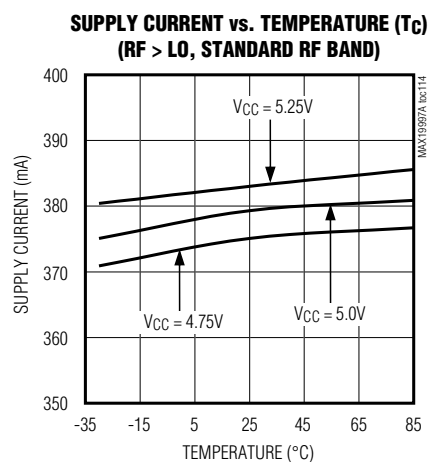
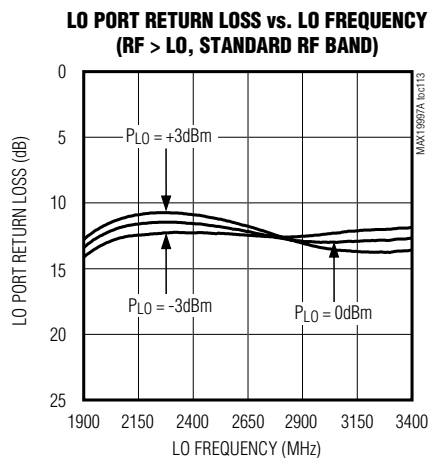
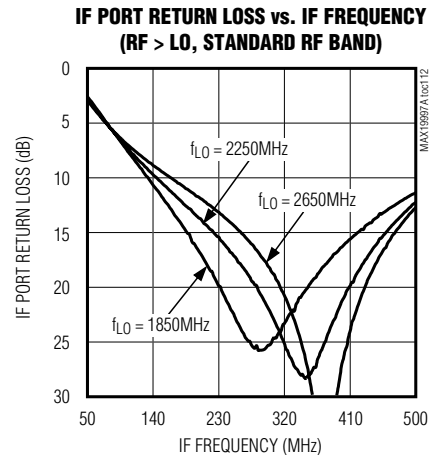
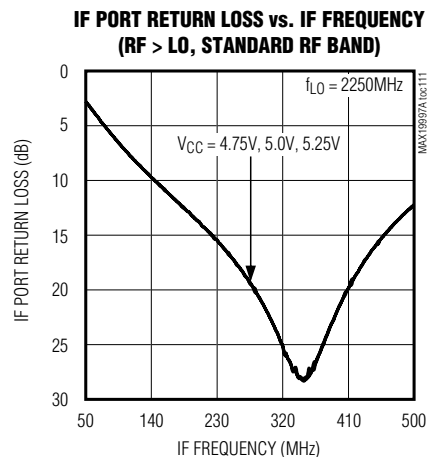
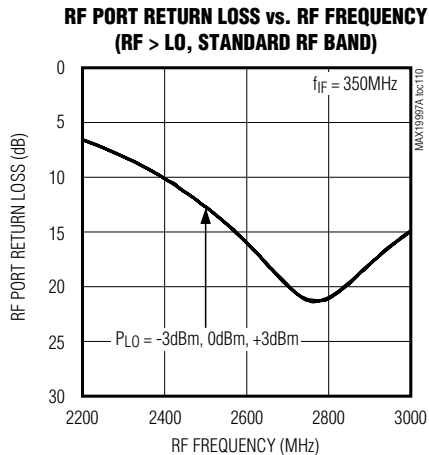

# MAX1997A

## Dual, SiGe High-Linearity, 1800MHz to 2900MHz Downconversion Mixer with LO Buffer

### Typical Operating Characteristics (continued)

(Typical Application Circuit, standard RF band (see Table 1),  $V_{CC} = 3.3V$ , LO is low-side injected for a 350MHz IF,  $P_{LO} = 0dBm$ ,  $P_{RF} = -5dBm$ ,  $T_C = +25^\circ C$ , unless otherwise noted.)

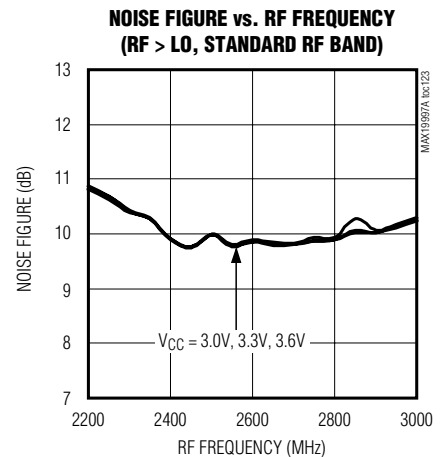
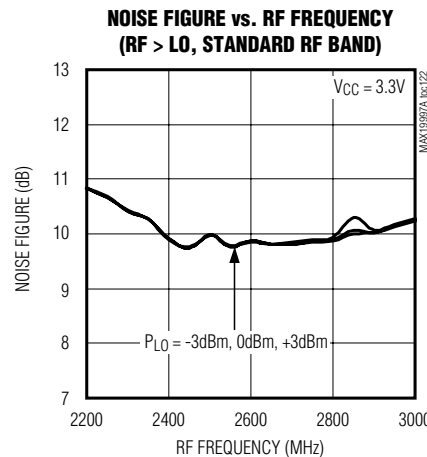
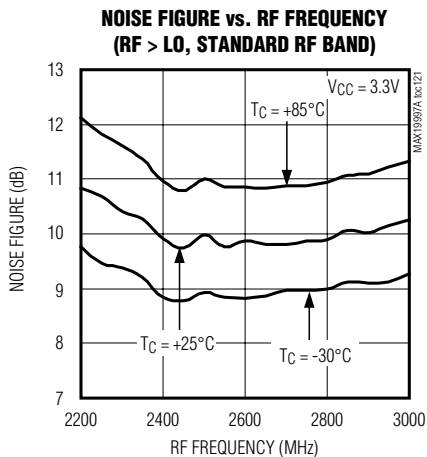
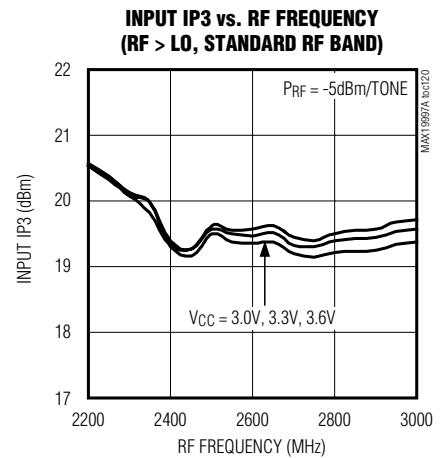
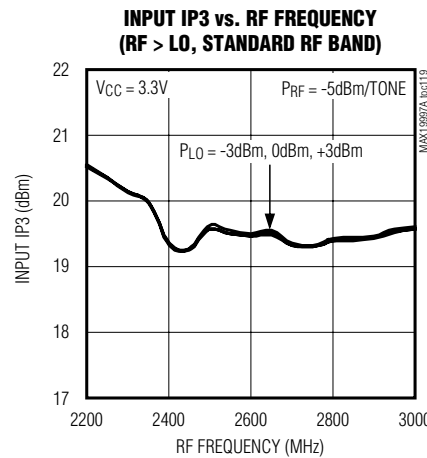
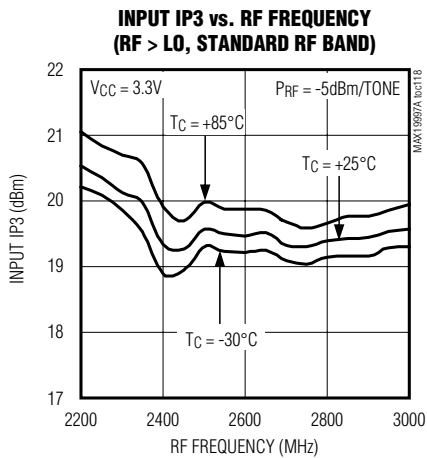
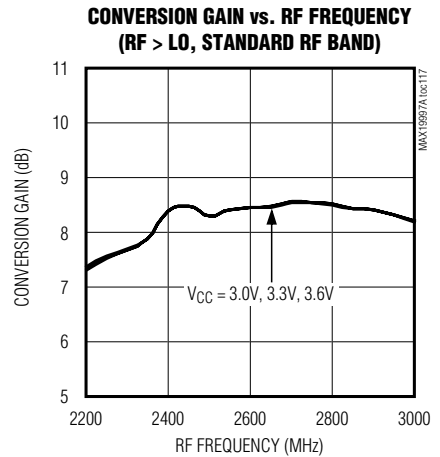
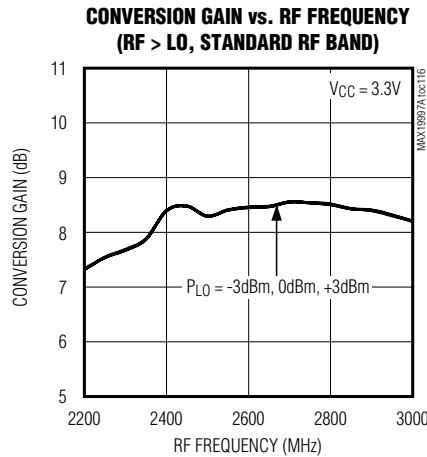
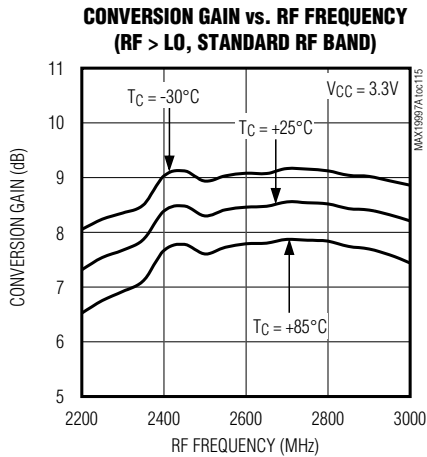



# MAX19997A

## Dual, SiGe High-Linearity, 1800MHz to 2900MHz Downconversion Mixer with LO Buffer

### Typical Operating Characteristics (continued)

(Typical Application Circuit, standard RF band (see Table 1),  $V_{CC} = 3.3V$ , LO is low-side injected for a 350MHz IF,  $P_{LO} = 0dBm$ ,  $P_{RF} = -5dBm$ ,  $T_C = +25^\circ C$ , unless otherwise noted.)

**2RF - 2LO RESPONSE vs. RF FREQUENCY (RF > LO, STANDARD RF BAND)**

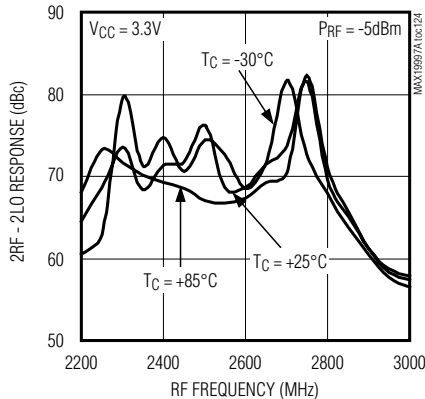

**2RF - 2LO RESPONSE vs. RF FREQUENCY (RF > LO, STANDARD RF BAND)**

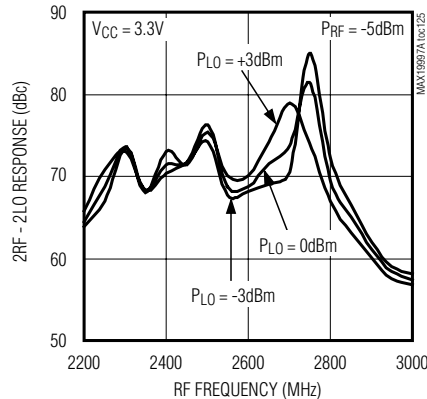

**2RF - 2LO RESPONSE vs. RF FREQUENCY (RF > LO, STANDARD RF BAND)**

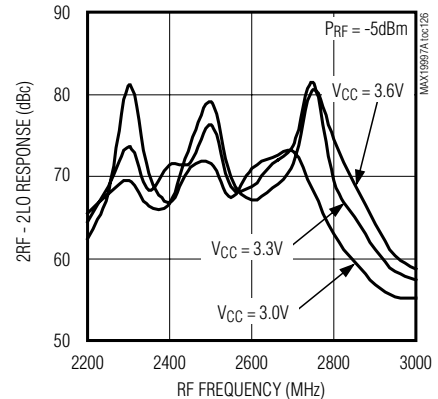

**3RF - 3LO RESPONSE vs. RF FREQUENCY (RF > LO, STANDARD RF BAND)**

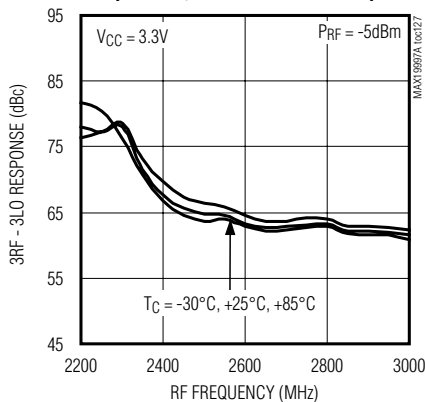

**3RF - 3LO RESPONSE vs. RF FREQUENCY (RF > LO, STANDARD RF BAND)**

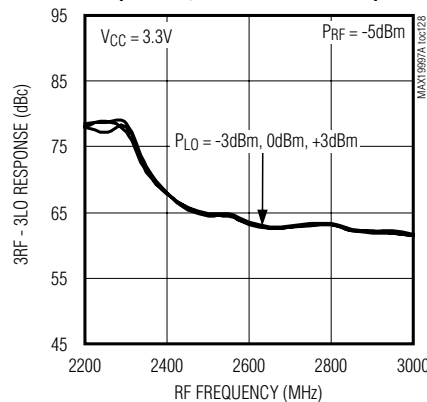

**3RF - 3LO RESPONSE vs. RF FREQUENCY (RF > LO, STANDARD RF BAND)**

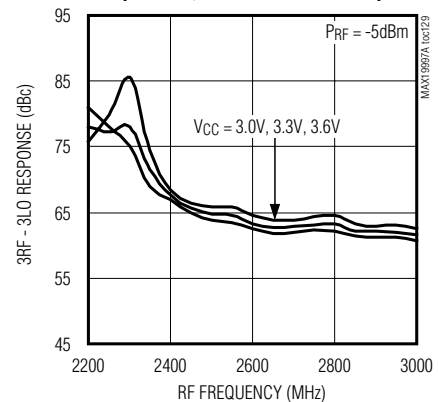

**INPUT P1dB vs. RF FREQUENCY (RF > LO, STANDARD RF BAND)**

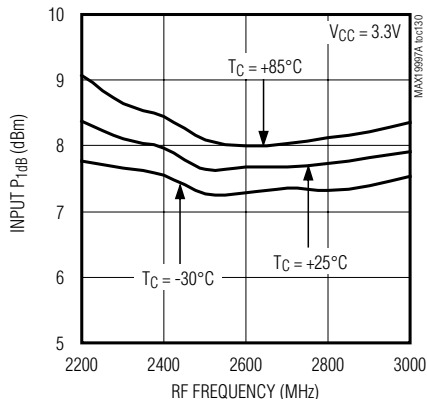

**INPUT P1dB vs. RF FREQUENCY (RF > LO, STANDARD RF BAND)**

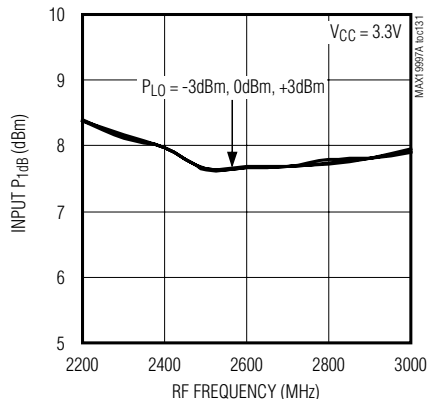

**INPUT P1dB vs. RF FREQUENCY (RF > LO, STANDARD RF BAND)**

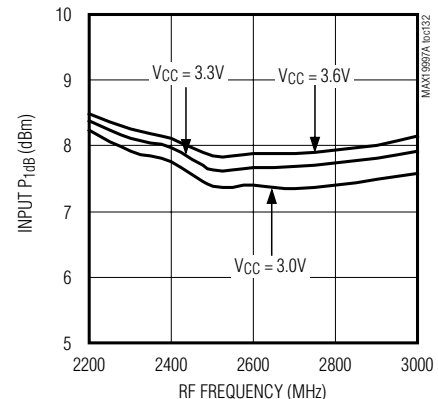

# MAX1997A

## Dual, SiGe High-Linearity, 1800MHz to 2900MHz Downconversion Mixer with LO Buffer

### Typical Operating Characteristics (continued)

(Typical Application Circuit, standard RF band (see Table 1),  $V_{CC} = 3.3V$ , LO is low-side injected for a 350MHz IF,  $P_{LO} = 0dBm$ ,  $P_{RF} = -5dBm$ ,  $T_C = +25^\circ C$ , unless otherwise noted.)

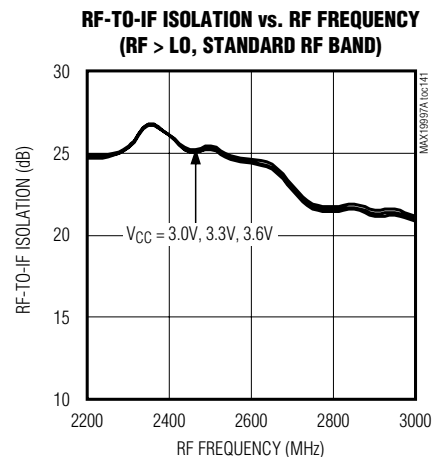
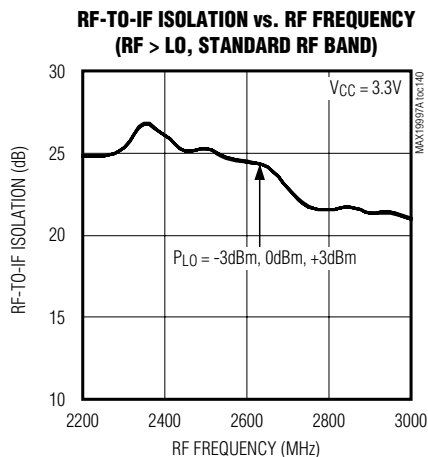
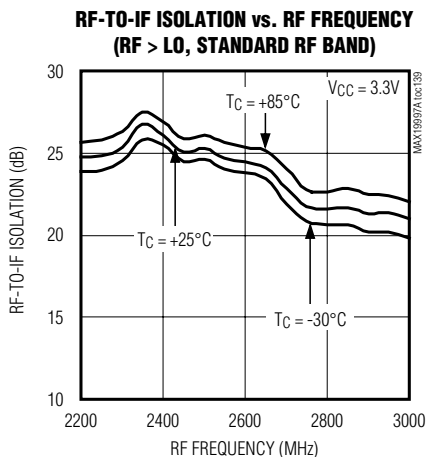
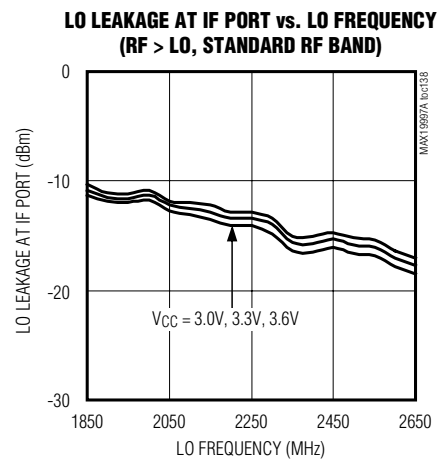
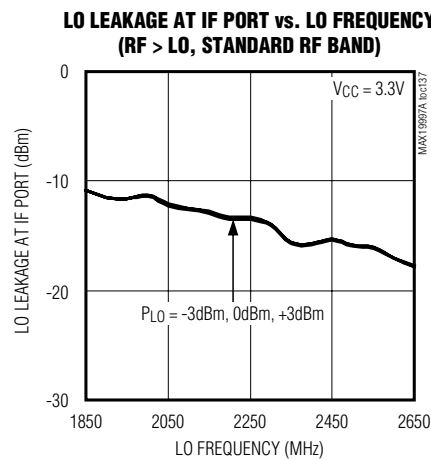
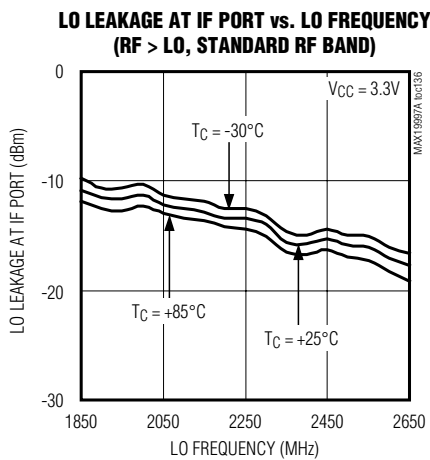
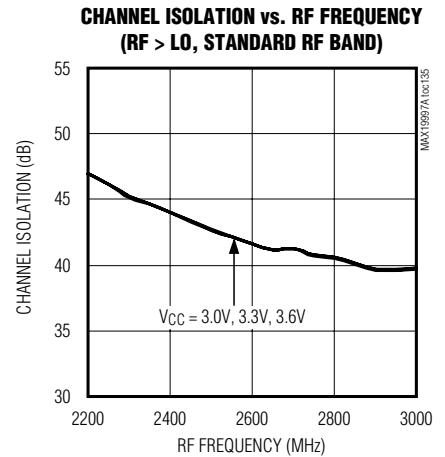
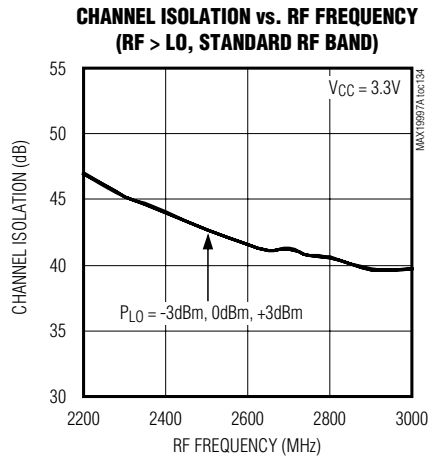
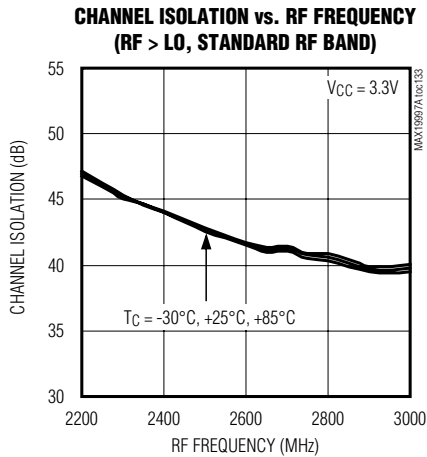

# MAX19997A

## Dual, SiGe High-Linearity, 1800MHz to 2900MHz Downconversion Mixer with LO Buffer

### Typical Operating Characteristics (continued)

(Typical Application Circuit, standard RF band (see Table 1),  $V_{CC} = 3.3V$ , LO is low-side injected for a 350MHz IF,  $P_{LO} = 0dBm$ ,  $P_{RF} = -5dBm$ ,  $T_C = +25^\circ C$ , unless otherwise noted.)

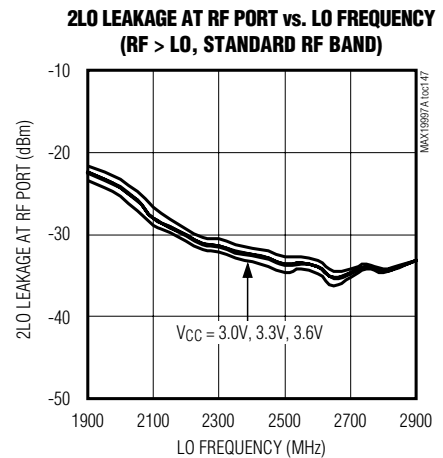
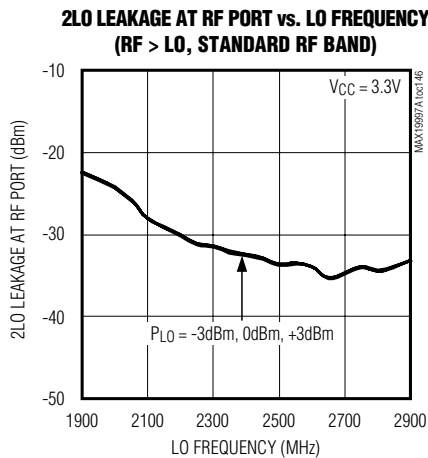
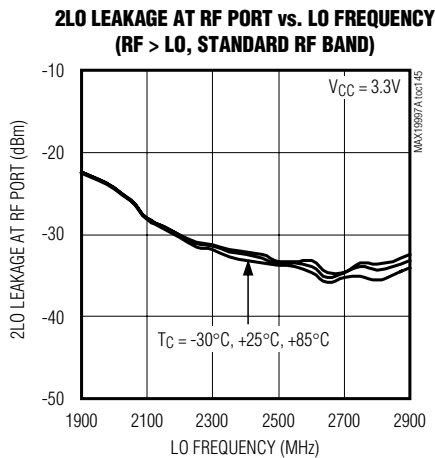
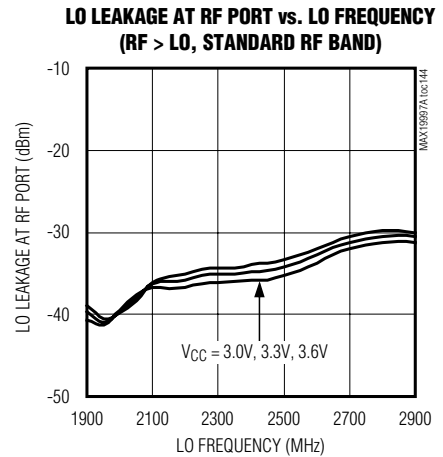
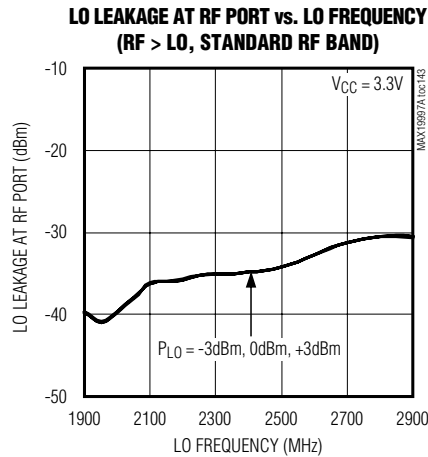
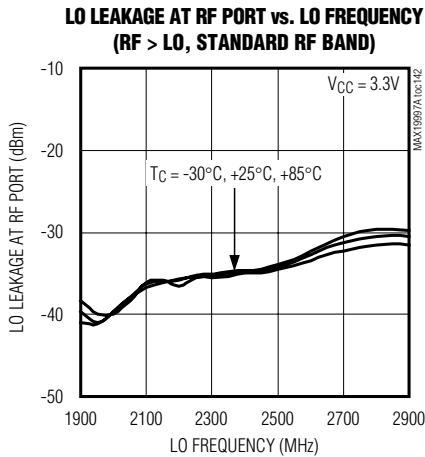

# MAX1997A

## Dual, SiGe High-Linearity, 1800MHz to 2900MHz Downconversion Mixer with LO Buffer

### Typical Operating Characteristics (continued)

(Typical Application Circuit, standard RF band (see Table 1),  $V_{CC} = 3.3V$ , LO is low-side injected for a 350MHz IF,  $P_{LO} = 0dBm$ ,  $P_{RF} = -5dBm$ ,  $T_C = +25^\circ C$ , unless otherwise noted.)

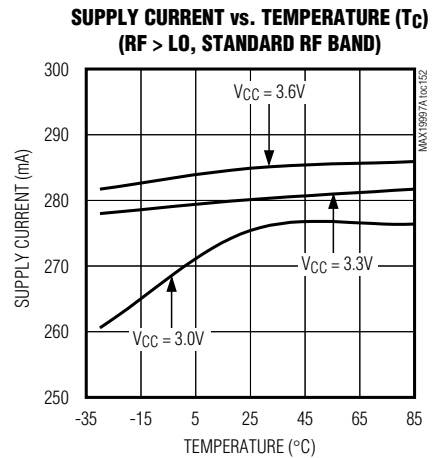
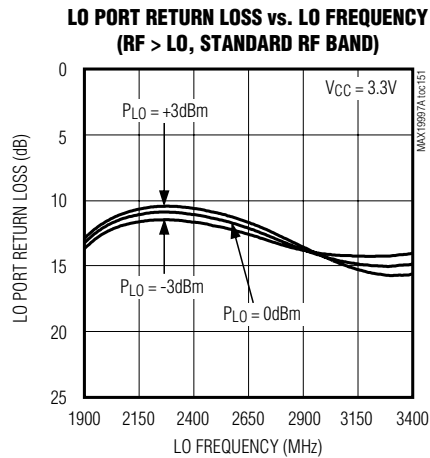
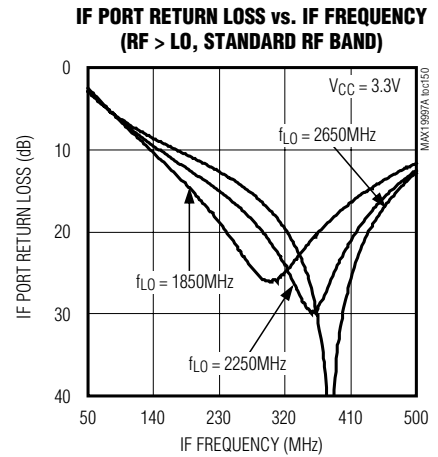
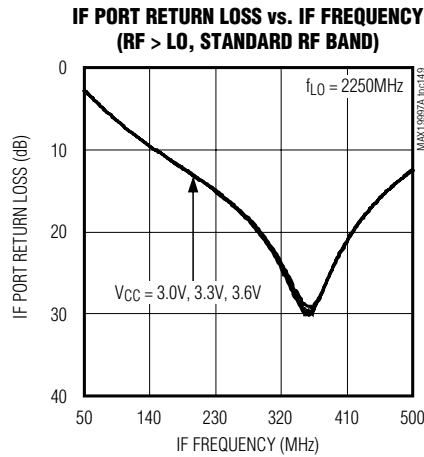
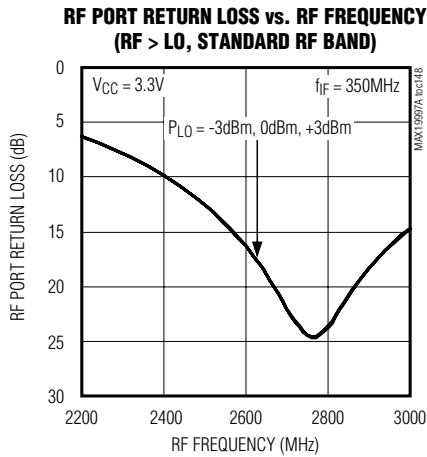

# MAX19997A

## Dual, SiGe High-Linearity, 1800MHz to 2900MHz Downconversion Mixer with LO Buffer

### Pin Description

PIN	NAME	FUNCTION
1	RFMAIN	Main Channel RF Input. Internally matched to 50Ω. Requires an input DC-blocking capacitor.
2, 5, 6, 8, 12, 15, 18, 23, 28, 31, 34	GND	Ground. Not internally connected. Ground these pins or leave unconnected.
3, 7, 20, 22, 24–27	GND	Ground. Internally connected to the exposed pad. Connect all ground pins and the exposed pad (EP) together.
4, 10, 16, 21, 30, 36	VCC	Power Supply. Connect bypass capacitors as close as possible to the pin (see the <i>Typical Application Circuit</i> ).
9	RFDIV	Diversity Channel RF Input. Internal matched to 50Ω. Requires a DC-blocking capacitor.
11	IFD_SET	IF Diversity Amplifier Bias Control. Connect a resistor from this pin to ground to set the bias current for the diversity IF amplifier.
13, 14	IFD+, IFD-	Diversity Mixer Differential IF Output. Connect pullup inductors from each of these pins to VCC (see the <i>Typical Application Circuit</i> ).
17	LO_ADJ_D	LO Diversity Amplifier Bias Control. Connect a resistor from this pin to ground to set the bias current for the diversity LO amplifier.
19	LO	Local Oscillator Input. This input is internally matched to 50Ω. Requires an input DC-blocking capacitor.
29	LO_ADJ_M	LO Main Amplifier Bias Control. Connect a resistor from this pin to ground to set the bias current for the main LO amplifier.
32, 33	IFM-, IFM+	Main Mixer Differential IF Output. Connect pullup inductors from each of these pins to VCC (see the <i>Typical Application Circuit</i> ).
35	IFM_SET	IF Main Amplifier Bias Control. Connect a resistor from this pin to ground to set the bias current for the main IF amplifier.
—	EP	Exposed Pad. Internally connected to GND. Solder this exposed pad to a PCB pad that uses multiple ground vias to provide heat transfer out of the device into the PCB ground planes. These multiple ground vias are also required to achieve the noted RF performance.

### Detailed Description

The MAX19997A dual, downconversion mixer provides high linearity and low noise figure for a multitude of 1800MHz to 2900MHz base-station applications. The device fully supports both low-side and high-side LO injection architectures for the 2300MHz to 2900MHz WiMAX, LTE, WCS, and MMDS bands. WCDMA, cdma2000, and PCS1900 applications utilizing high-side LO injection architectures are also supported by adding one additional tuning element (a shunt inductor) on each RF port.

The MAX19997A operates over an LO range of 1950MHz to 3400MHz and an IF range of 50MHz to 550MHz. Integrated baluns and matching circuitry allow 50Ω single-ended interfaces to the RF and LO ports.

The integrated LO buffer provides a high drive level to the mixer core, reducing the LO drive required at the MAX19997A's input to a range of -3dBm to +3dBm. The IF port incorporates a differential output, which is ideal for providing enhanced 2RF - 2LO (low-side injection) and 2LO - 2RF (high-side injection) performance.

### RF Input and Balun

The MAX19997A's two RF inputs (RFMAIN and RFDIV) provide a 50Ω match when combined with a series DC-blocking capacitor. This DC-blocking capacitor is required as the input is internally DC shorted to ground through each channel's on-chip balun. When using a 22pF DC-blocking capacitor, the RF port input return loss is typically 15dB over the RF frequency range of 2600MHz to 2900MHz.

# MAX19997A

## Dual, SiGe High-Linearity, 1800MHz to 2900MHz Downconversion Mixer with LO Buffer

The MAX19997A's RF range can be further extended down to 1800MHz by adding one additional tuning element on each RF port. For 1950MHz RF applications, connect a 12nH shunt inductor from pins 1 and 9 to ground. Also, change the value of the DC-blocking capacitors (C1 and C8) from 22pF to 1pF. See the *Typical Application Circuit* for details.

### LO Input, Buffer, and Balun

A two-stage internal LO buffer allows a wide input power range for the LO drive. All guaranteed specifications are for an LO signal power from -3dBm to +3dBm. The on-chip low-loss balun, along with an LO buffer, drives the double-balanced mixer. All interfacing and matching components from the LO input to the IF outputs are integrated on-chip.

### High-Linearity Mixer

The core of the MAX19997A is a pair of double-balanced, high-performance passive mixers. Exceptional linearity is provided by the large LO swing from the on-chip LO buffer. When combined with the integrated IF amplifiers, the cascaded IIP3, 2RF - 2LO rejection, and NF performance are typically +24dBm IIP3, -67dBc, and 10.3dB, respectively for low-side LO injection architectures covering the 2300MHz to 2900MHz band. Cascaded performance levels are comparable for high-side LO injection architectures; IIP3, 2LO - 2RF rejection, and NF levels are typically rated at +24dBm IIP3, -73dBc, and 10.4dB, respectively over the same 2300MHz to 2900MHz band.

### Differential IF Output Amplifier

The MAX19997A mixers have an IF frequency range of 50MHz to 550MHz. The differential, open-collector IF output ports require external pullup inductors to VCC. These pullup inductors are also used to resonate out the parasitic shunt capacitance of the IC, PCB components, and PCB to provide an optimized IF match at the frequency of interest. Note that differential IF outputs are ideal for providing enhanced 2RF - 2LO and 2LO - 2RF rejection performance. Single-ended IF applications require a 4:1 balun to transform the 200Ω differential output impedance to a 50Ω single-ended output. After the balun, voltage standing-wave ratio (VSWR) is typically 1.2:1.

## Applications Information

### Input and Output Matching

The RF and LO inputs are internally matched to 50Ω. No matching components are required for RF frequencies ranging from 2400MHz to 2900MHz. RF and LO inputs require only DC-blocking capacitors for interfacing.

If desired, the RF band can be extended down to 1800MHz by adding two external matching components on each RF port. See the *Typical Application Circuit* and Table 2 for details.

The IF output impedance is 200Ω (differential). For evaluation, an external low-loss 4:1 (impedance ratio) balun transforms this impedance down to a 50Ω single-ended output (see the *Typical Application Circuit*).

### Reduced-Power Mode

Each channel of the MAX19997A has two pins (LO\_ADJ\_-, IF\_-SET) that allow external resistors to set the internal bias currents. Nominal values for these resistors are shown in Tables 1 and 2. Larger-value resistors can be used to reduce power dissipation at the expense of some performance loss. If ±1% resistors are not readily available, ±5% resistors may be substituted.

Significant reductions in power consumption can be realized by operating the mixer with an optional supply voltage of +3.3V. Doing so reduces the overall power consumption by up to 53%. See the *+3.3V Supply, Low-Side LO Injection AC Electrical Characteristics* table and the relevant +3.3V curves in the *Typical Operating Characteristics* section to evaluate the power vs. performance tradeoffs.

### Layout Considerations

A properly designed PCB is an essential part of any RF/microwave circuit. Keep RF signal lines as short as possible to reduce losses, radiation, and inductance. For the best performance, route the ground pin traces directly to the exposed pad under the package.

The PCB exposed pad **MUST** be connected to the ground plane of the PCB. It is suggested that multiple vias be used to connect this pad to the lower-level ground planes. This method provides a good RF/thermal-conduction path for the device. Solder the exposed pad on the bottom of the device package to the PCB. The MAX19997A evaluation kit can be used as a reference for board layout. Gerber files are available upon request at [www.maximintegrated.com](http://www.maximintegrated.com).

# MAX19997A

## Dual, SiGe High-Linearity, 1800MHz to 2900MHz Downconversion Mixer with LO Buffer

### Power-Supply Bypassing

Proper voltage supply bypassing is essential for high-frequency circuit stability. Bypass each V<sub>CC</sub> pin with the capacitors shown in the *Typical Application Circuit*.

### Exposed Pad RF/Thermal Considerations

The exposed pad (EP) of the MAX19997A's 36-pin TQFN-EP package provides a low thermal-resistance

path to the die. It is important that the PCB on which the MAX19997A is mounted be designed to conduct heat from the EP. In addition, provide the EP with a low-inductance path to electrical ground. The EP **MUST** be soldered to a ground plane on the PCB, either directly or through an array of plated via holes.

**Table 1. Standard RF Band Application Circuit Component Values (Optimized for Frequencies Ranging from 2400MHz to 2900MHz)**

DESIGNATION	QTY	DESCRIPTION	COMPONENT SUPPLIER
C1, C8	2	22pF microwave capacitors (0402)	Murata Electronics North America, Inc.
C14	1	1.5pF microwave capacitor (0402)	Murata Electronics North America, Inc.
C4, C9, C13, C15, C17, C18	6	0.01μF microwave capacitors (0402)	Murata Electronics North America, Inc.
C10, C11, C12, C19, C20, C21	6	82pF microwave capacitors (0603)	Murata Electronics North America, Inc.
L1, L2, L3, L4	4	120nH wire-wound high-Q inductors* (0805)	Coilcraft, Inc.
L7, L8	0	Not used	—
R1, R4	2	750Ω ±1% resistors (0402). Use for <b>V<sub>CC</sub> = 5.0V</b> applications. Larger values can be used to reduce power at the expense of some performance loss. See the <i>Typical Operating Characteristics</i> section.	Digi-Key Corp.
		1.1kΩ ±1% resistors (0402). Use for <b>V<sub>CC</sub> = 3.3V</b> applications. Larger values can be used to reduce power at the expense of some performance loss. See the <i>Typical Operating Characteristics</i> section.	Digi-Key Corp.
R2, R5	2	698Ω ±1% resistors (0402). Use for <b>V<sub>CC</sub> = 5.0V</b> applications. Larger values can be used to reduce power at the expense of some performance loss. See the <i>Typical Operating Characteristics</i> section.	Digi-Key Corp.
		845Ω ±1% resistors (0402). Use for <b>V<sub>CC</sub> = 3.3V</b> applications. Larger values can be used to reduce power at the expense of some performance loss. See the <i>Typical Operating Characteristics</i> section.	Digi-Key Corp.
R3, R6	2	0Ω resistors (1206). These resistors can be increased in value to reduce power dissipation in the device, but reduces the compression point. Full P <sub>1dB</sub> performance achieved using 0Ω.	Digi-Key Corp.
T1, T2	2	4:1 IF baluns (TC4-1W-17+)	Mini-Circuits
U1	1	MAX19997A IC (36 TQFN-EP)	Maxim Integrated Products, Inc.

\*Use 390nH (0805) inductors for an IF frequency of 200MHz. Contact the factory for details.

# MAX1997A

## Dual, SiGe High-Linearity, 1800MHz to 2900MHz Downconversion Mixer with LO Buffer

**Table 2. Extended RF Band Application Circuit Component Values (Optimized for 1950MHz Operation)**

DESIGNATION	QTY	DESCRIPTION	COMPONENT SUPPLIER
C1, C8	2	1pF microwave capacitors (0402)	Murata Electronics North America, Inc.
C14	1	1.5pF microwave capacitor (0402)	Murata Electronics North America, Inc.
C4, C9, C13, C15, C17, C18	6	0.01μF microwave capacitors (0402)	Murata Electronics North America, Inc.
C10, C11, C12, C19, C20, C21	6	82pF microwave capacitors (0603)	Murata Electronics North America, Inc.
L1, L2, L3, L4	4	120nH wire-wound high-Q inductors* (0805)	Coilcraft, Inc.
L7, L8	2	12nH inductors (0402). Use to improve RF match from 1800MHz to 2400MHz. Connect L7 and L8 from pins 1 and 9, respectively, to ground.	Coilcraft, Inc.
R1, R4	2	750Ω ±1% resistors (0402). Use for <b>V<sub>CC</sub> = 5.0V</b> applications. Larger values can be used to reduce power at the expense of some performance loss. See the <i>Typical Operating Characteristics</i> section.	Digi-Key Corp.
R2, R5	2	698Ω ±1% resistors (0402). Use for <b>V<sub>CC</sub> = 5.0V</b> applications. Larger values can be used to reduce power at the expense of some performance loss. See the <i>Typical Operating Characteristics</i> section.	Digi-Key Corp.
R3, R6	2	0Ω resistors (1206). These resistors can be increased in value to reduce power dissipation in the device, but reduces the compression point. Full P <sub>1dB</sub> performance achieved using 0Ω.	Digi-Key Corp.
T1, T2	2	4:1 IF baluns (TC4-1W-17+)	Mini-Circuits
U1	1	MAX1997A IC (36 TQFN-EP)	Maxim Integrated Products, Inc.

\*Use 390nH (0805) inductors for an IF frequency of 200MHz. Contact the factory for details.



# MAX19997A

## Dual, SiGe High-Linearity, 1800MHz to 2900MHz Downconversion Mixer with LO Buffer

### Typical Application Circuit

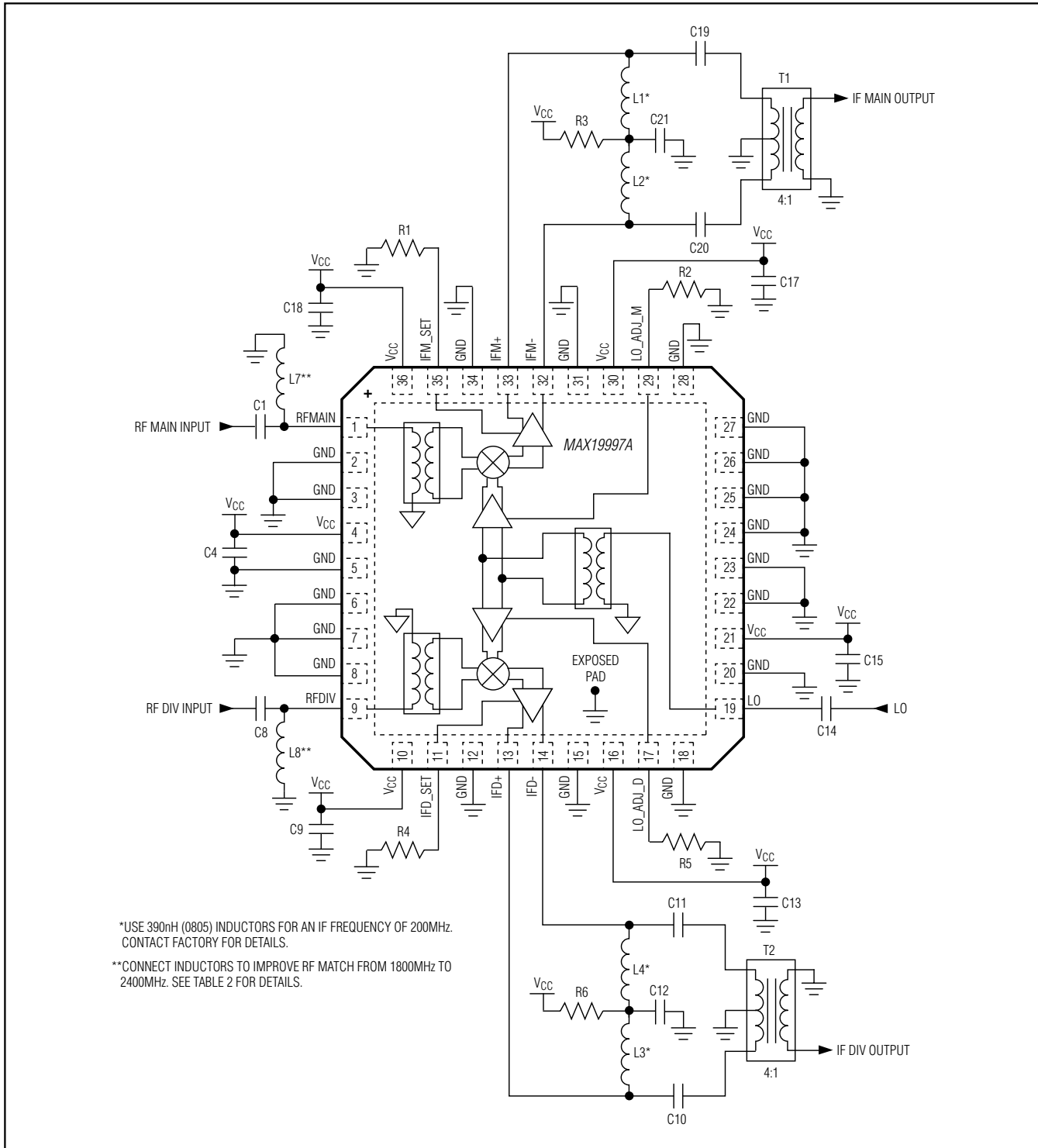

# MAX1997A

## Dual, SiGe High-Linearity, 1800MHz to 2900MHz Downconversion Mixer with LO Buffer

### Pin Configuration/ Functional Block Diagram

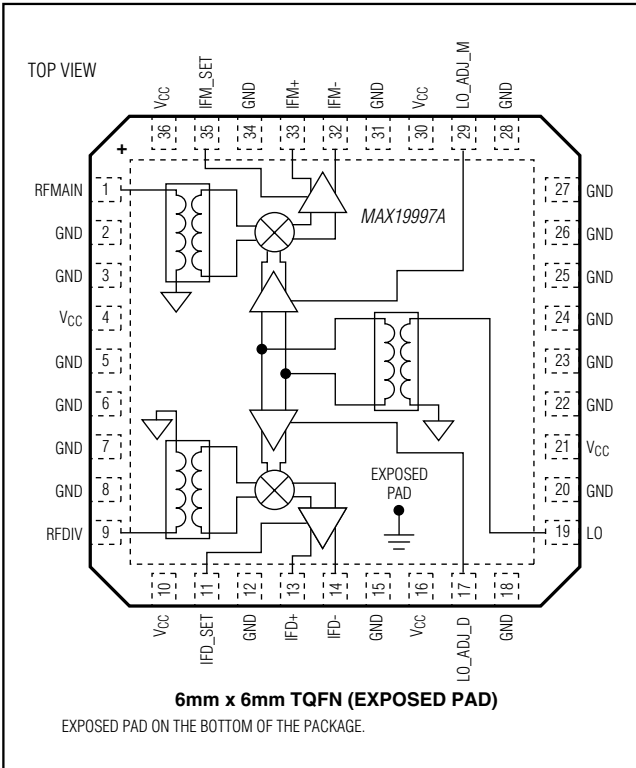

### Chip Information

PROCESS: SiGe BiCMOS

### Reliability Information

<http://www.maximintegrated.com/reliability/product/MAX1997A.pdf>

### Lead-Free/RoHS Considerations

<http://www.maximintegrated.com/emmi/faq.cfm>

### Package Information

For the latest package outline information and land patterns (footprints), go to [www.maximintegrated.com/packages](http://www.maximintegrated.com/packages). Note that a "+", "#", or "-" in the package code indicates RoHS status only. Package drawings may show a different suffix character, but the drawing pertains to the package regardless of RoHS status.

PACKAGE TYPE	PACKAGE CODE	OUTLINE NO.	LAND PATTERN NO.
36 TQFN-EP	T3666+2	<a href="#">21-0141</a>	<a href="#">90-0049</a>

# MAX19997A

## Dual, SiGe High-Linearity, 1800MHz to 2900MHz Downconversion Mixer with LO Buffer

### Revision History

REVISION NUMBER	REVISION DATE	DESCRIPTION	PAGES CHANGED
0	10/08	Initial release	—
1	9/10	Minor style edits	2, 3, 4, 10, 15, 29, 30, 34
2	2/11	Increased IF frequency range from 50MHz to 550MHz	1, 3, 29, 30
3	8/11	Expanded +5.0V Supply DC Electrical Characteristics table without changing existing limits	2
4	1/13	Updated <i>General Description, Features, Ordering Information, Package Thermal Characteristics, +5.0V Supply, High-Side Lo Injection AC Electrical Characteristics</i> table, <i>+5.0V Supply, Low-Side Lo Injection AC Electrical Characteristics</i> table, and URL, and added <i>Reliability Information</i> and <i>Lead-Free-/RoHS Considerations</i> sections	1–6, 30, 34



Maxim Integrated cannot assume responsibility for use of any circuitry other than circuitry entirely embodied in a Maxim Integrated product. No circuit patent licenses are implied. Maxim Integrated reserves the right to change the circuitry and specifications without notice at any time. The parametric values (min and max limits) shown in the Electrical Characteristics table are guaranteed. Other parametric values quoted in this data sheet are provided for guidance.