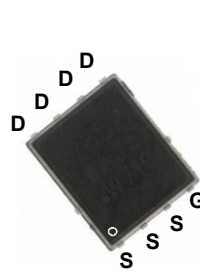
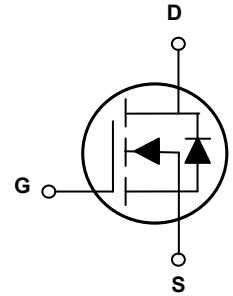


### Main Product Characteristics

$BV_{DSS}$	65V
$R_{DS(ON)}$	3.5m $\Omega$
$I_D$	120A



PPAK5X6



Schematic Diagram

### Features and Benefits

- Advanced MOSFET process technology
- Ideal for high efficiency switched mode power supplies
- Low on-resistance with low gate charge
- Fast switching and reverse body recovery



### Description

The GSFP0612 utilizes the latest techniques to achieve high cell density and low on-resistance. These features make this device extremely efficient and reliable for use in high efficiency switch mode power supply and a wide variety of other applications.

### Absolute Maximum Ratings ( $T_C=25^\circ\text{C}$ unless otherwise specified)

Parameter	Symbol	Max.	Unit
Drain-Source Voltage	$V_{DS}$	65	V
Gate-Source Voltage	$V_{GS}$	$\pm 20$	V
Drain Current-Continuous ( $T_C=25^\circ\text{C}$ )	$I_D$	120	A
Drain Current-Continuous ( $T_C=100^\circ\text{C}$ )		76	
Drain Current-Pulsed <sup>1</sup>	$I_{DM}$	480	A
Single Pulse Avalanche Energy <sup>2</sup>	$E_{AS}$	218	mJ
Single Pulse Avalanche Current <sup>2</sup>	$I_{AS}$	66	A
Power Dissipation ( $T_C=25^\circ\text{C}$ )	$P_D$	125	W
Power Dissipation-Derate above $25^\circ\text{C}$		1	
Thermal Resistance, Junction-to-Ambient	$R_{\theta JA}$	62	$^\circ\text{C}/\text{W}$
Thermal Resistance, Junction-to-Case	$R_{\theta JC}$	1	$^\circ\text{C}/\text{W}$
Operating Junction Temperature Range	$T_J$	-55 To +150	$^\circ\text{C}$
Storage Temperature Range	$T_{STG}$	-55 To +150	$^\circ\text{C}$

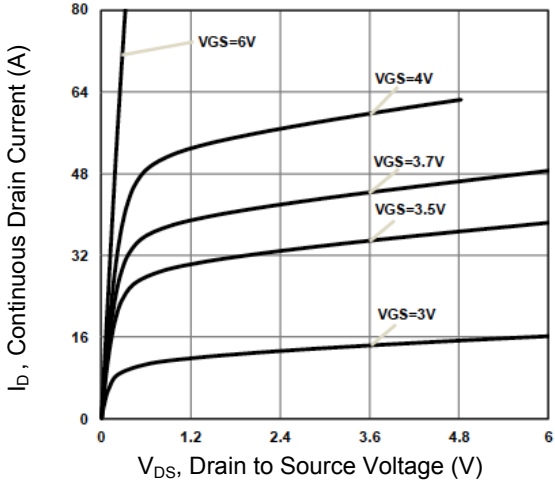
**Electrical Characteristics** ( $T_J=25^\circ\text{C}$  unless otherwise specified)

Parameter	Symbol	Conditions	Min.	Typ.	Max.	Unit
<b>On/Off Characteristics</b>						
Drain-Source Breakdown Voltage	$BV_{DSS}$	$V_{GS}=0V, I_D=250\mu A$	65	-	-	V
Drain-Source Leakage Current	$I_{DSS}$	$V_{DS}=60V, V_{GS}=0V, T_J=25^\circ\text{C}$	-	-	1	$\mu A$
		$V_{DS}=48V, V_{GS}=0V, T_J=85^\circ\text{C}$	-	-	10	
Gate-Source Leakage Current	$I_{GSS}$	$V_{GS}=\pm 20V, V_{DS}=0V$	-	-	$\pm 100$	nA
Static Drain-Source On-Resistance	$R_{DS(ON)}$	$V_{GS}=10V, I_D=30A$	-	2.9	3.5	m $\Omega$
		$V_{GS}=4.5V, I_D=20A$	-	4.1	5.3	
Gate Threshold Voltage	$V_{GS(th)}$	$V_{GS}=V_{DS}, I_D=250\mu A$	1.2	1.6	2.5	V
Forward Transconductance	$g_{fs}$	$V_{DS}=10V, I_D=3A$	-	16	-	S
<b>Dynamic and Switching Characteristics</b>						
Total Gate Charge <sup>3,4</sup>	$Q_g$	$V_{DS}=30V, I_D=60A, V_{GS}=10V$	-	52	78	nC
Gate-Source Charge <sup>3,4</sup>	$Q_{gs}$		-	7	11	
Gate-Drain Charge <sup>3,4</sup>	$Q_{gd}$		-	18	27	
Turn-On Delay Time <sup>3,4</sup>	$t_{d(on)}$	$V_{DD}=30V, R_G=6\Omega, V_{GS}=10V, I_D=60A$	-	14	21	nS
Rise Time <sup>3,4</sup>	$t_r$		-	18	27	
Turn-Off Delay Time <sup>3,4</sup>	$t_{d(off)}$		-	39	59	
Fall Time <sup>3,4</sup>	$t_f$		-	14	21	
Input Capacitance	$C_{iss}$	$V_{DS}=30V, V_{GS}=0V, F=1\text{MHz}$	-	2400	3600	pF
Output Capacitance	$C_{oss}$		-	840	1260	
Reverse Transfer Capacitance	$C_{rss}$		-	37	56	
Gate Resistance	$R_g$	$V_{GS}=0V, V_{DS}=0V, F=1\text{MHz}$	-	1.4	-	$\Omega$
<b>Drain-Source Diode Characteristics and Maximum Ratings</b>						
Continuous Source Current	$I_S$	$V_G=V_D=0V, \text{Force Current}$	-	-	120	A
Pulsed Source Current	$I_{SM}$		-	-	240	A
Diode Forward Voltage	$V_{sd}$	$V_{GS}=0V, I_S=1A, T_J=25^\circ\text{C}$	-	-	1	V
Reverse Recovery Time <sup>3</sup>	$t_{rr}$	$V_R=50V, I_S=10A, di/dt=100A/\mu s, T_J=25^\circ\text{C}$	-	65	-	nS
Reverse Recovery Charge <sup>3</sup>	$Q_{rr}$		-	100	-	nC

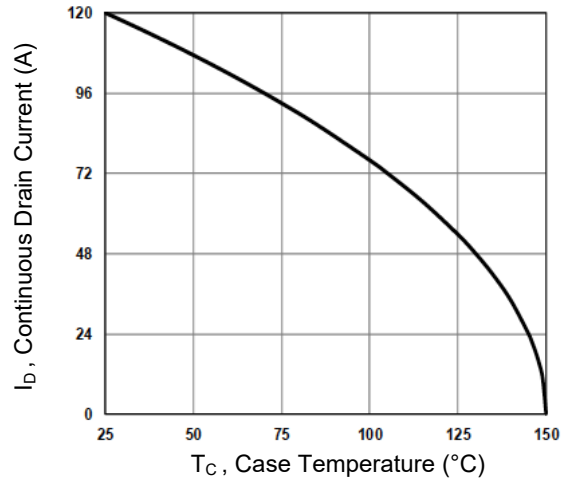
Note:

1. Repetitive rating: Pulsed width limited by maximum junction temperature.
2.  $V_{DD}=25V, V_{GS}=10V, L=0.1\text{mH}, I_{AS}=66A, R_G=25\Omega, \text{starting } T_J=25^\circ\text{C}$ .
3. Pulse test: pulse width  $\leq 300\mu s, \text{duty cycle} \leq 2\%$ .
4. Essentially independent of operation temperature.

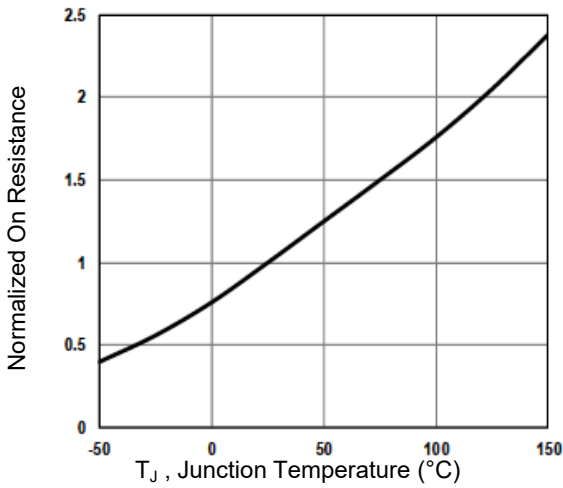
**Typical Electrical and Thermal Characteristic Curves**



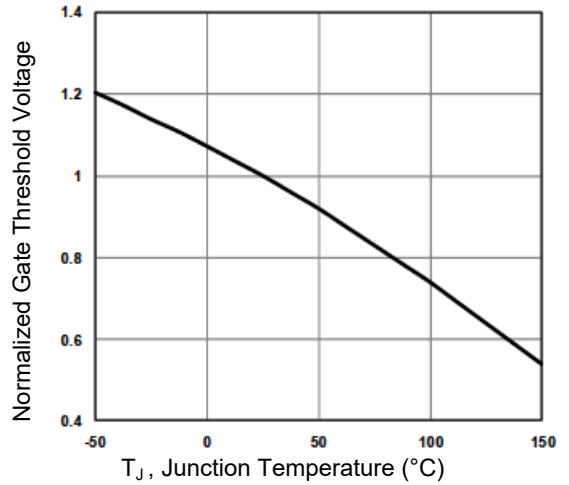
**Figure 1. Typical Output Characteristics**



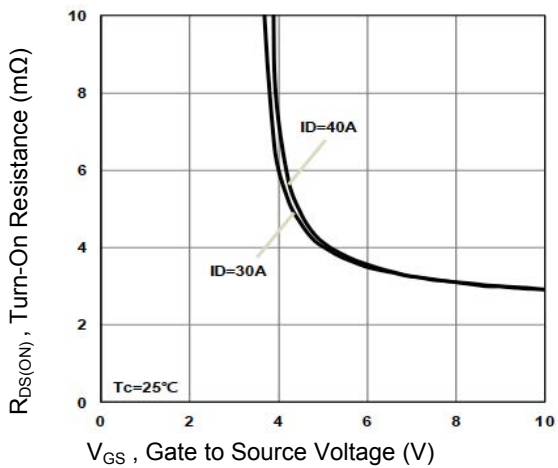
**Figure 2. Continuous Drain Current vs.  $T_C$**



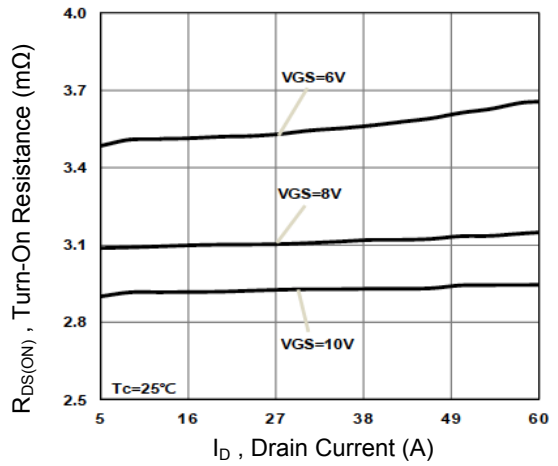
**Figure 3. Normalized  $R_{DS(on)}$  vs.  $T_J$**



**Figure 4. Normalized  $V_{th}$  vs.  $T_J$**

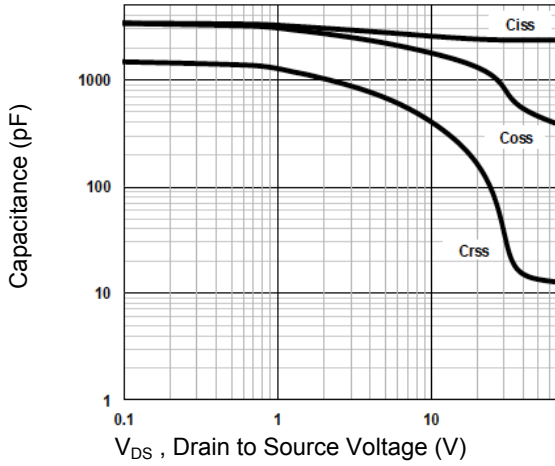


**Figure 5. Turn-On Resistance vs.  $V_{GS}$**

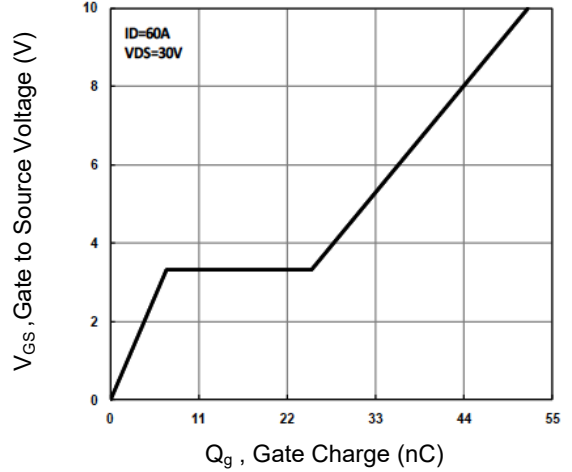


**Figure 6. Turn-On Resistance vs.  $I_D$**

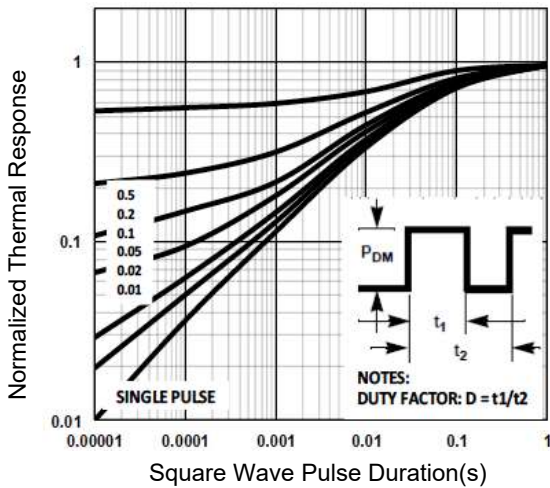
**Typical Electrical and Thermal Characteristic Curves**



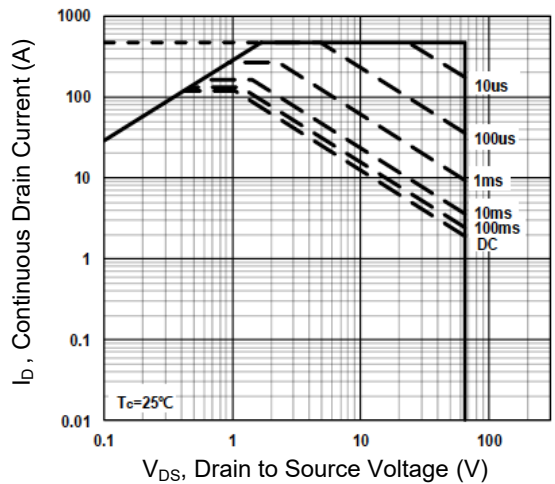
**Figure 7. Capacitance Characteristics**



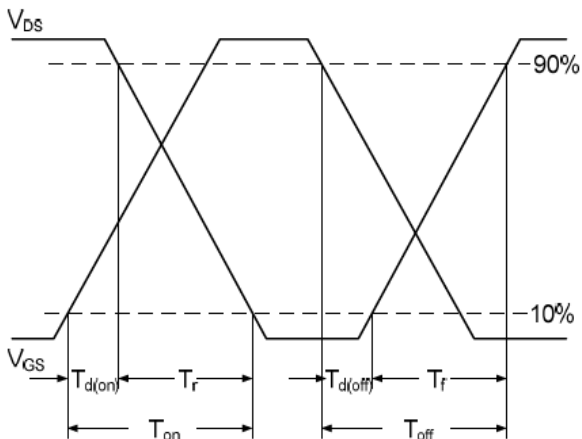
**Figure 8. Gate Charge Waveform**



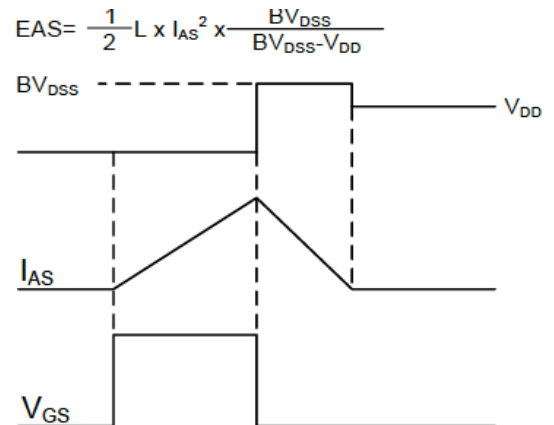
**Figure 9. Normalized Transient Impedance**



**Figure 10. Maximum Safe Operation Area**

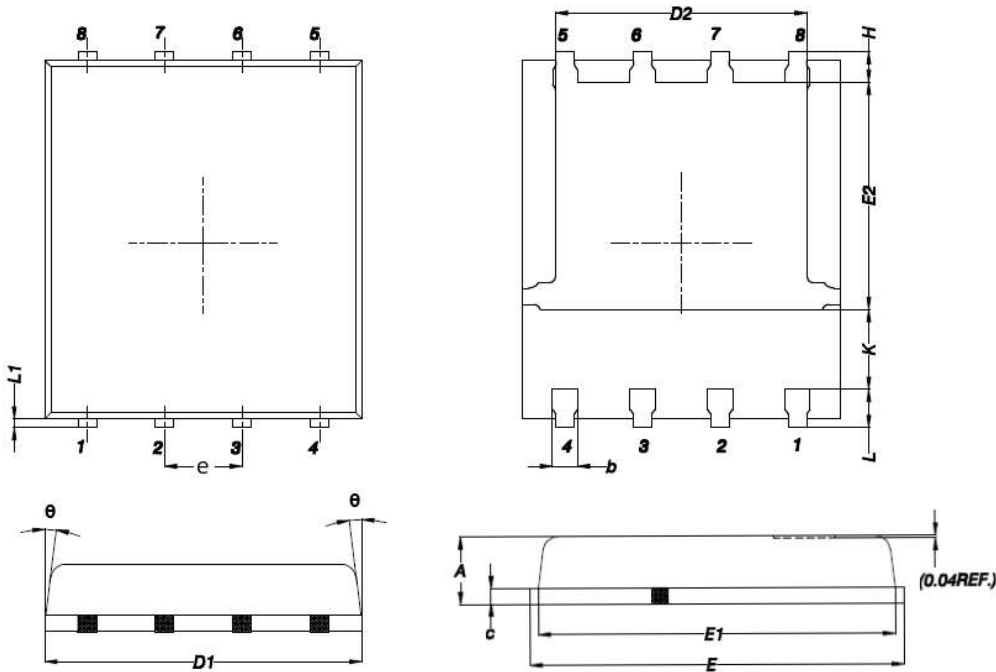


**Figure 11. Switching Time Waveform**



**Figure 12. E<sub>AS</sub> Waveform**

**Package Outline Dimensions (PPAK5x6)**



Symbol	Dimensions In Millimeters		Dimensions In Inches	
	MAX	MIN	MAX	MIN
A	1.200	0.850	0.047	0.031
b	0.510	0.330	0.020	0.013
C	0.300	0.200	0.012	0.008
D1	5.400	4.800	0.212	0.189
D2	4.310	3.610	0.170	0.142
E	6.300	5.850	0.248	0.230
E1	5.960	5.450	0.235	0.215
E2	3.920	3.300	0.154	0.130
e	1.27BSC		0.05BSC	
H	0.650	0.380	0.026	0.015
K	-	1.100	-	0.043
L	0.710	0.380	0.028	0.015
L1	0.250	0.050	0.009	0.002
θ	12°	0°	12°	0°