

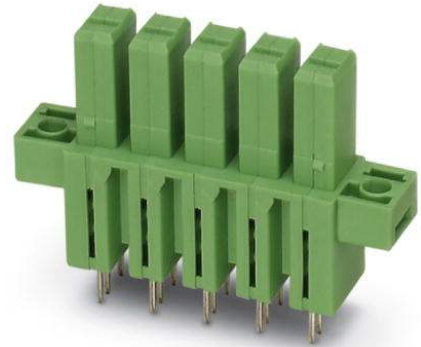

IPCV 5/ 4-GF-7,62

Order No.: 1708954

The figure shows a 5-pos. version of the product

<http://eshop.phoenixcontact.de/phoenix/treeViewClick.do?UID=1708954>

Header, Nominal current: 41 A, Rated voltage (III/2): 630 V, Number of positions: 4, Pitch: 7.62 mm, Color: green, Metal surface: Sn, Assembly: Soldering

Commercial data	
GTIN (EAN)	 4 046356 089937
Note	Made-to-order
sales group	E521
Pack	50 pcs.
Customs tariff	85366990
Catalog page information	Page 397 (CC-2009)

Product notesWEEE/RoHS-compliant since:
08/11/2005

<http://www.download.phoenixcontact.com>
Please note that the data given here has been taken from the online catalog. For comprehensive information and data, please refer to the user documentation. The General Terms and Conditions of Use apply to Internet downloads.

Technical data	
Dimensions / positions	
Length	12.8 mm
Pitch	7.62 mm
Dimension a	22.86 mm
Number of positions	4

Pin dimensions	1,2x0,8
Pin spacing	7.62 mm
Hole diameter	1.3 mm

Technical data

Range of articles	IPCV 5/...-GF
Insulating material group	I
Rated surge voltage (III/3)	6 kV
Rated surge voltage (III/2)	6 kV
Rated surge voltage (II/2)	6 kV
Rated voltage (III/2)	630 V
Rated voltage (II/2)	1000 V
Connection in acc. with standard	EN-VDE
Nominal current I_N	41 A
Nominal voltage U_N	630 V
Maximum load current	41 A
Insulating material	PA
Inflammability class acc. to UL 94	V0
Nominal voltage, UL/CUL Use Group B	300 V
Nominal current, UL/CUL Use Group B	41 A
Nominal voltage, UL/CUL Use Group C	300 V
Nominal current, UL/CUL Use Group C	41 A
Nominal voltage, UL/CUL Use Group D	600 V
Nominal current, UL/CUL Use Group D	5 A

Certificates / Approvals



Certification

CUL, UL

Diagrams/Drawings

Drilling plan/solder pad geometry

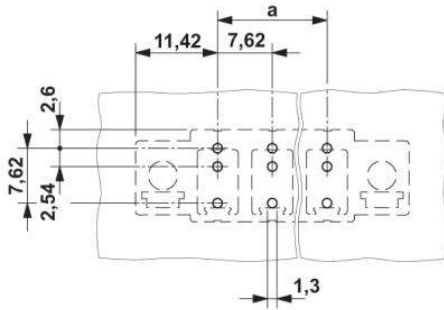

Dimensioned drawing

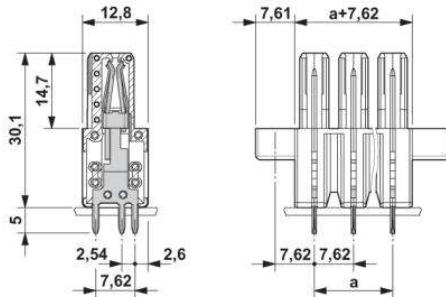

Address

PHOENIX CONTACT Deutschland GmbH
Flachmarktstr. 8
32825 Blomberg, Germany
Phone +49 5235 3 12000
Fax +49 5235 3 41200
<http://www.phoenixcontact.de>



© 2011 Phoenix Contact
Technical modifications reserved;