

PRODUCT PARTNUMBER
10145445-XXXXXXLF

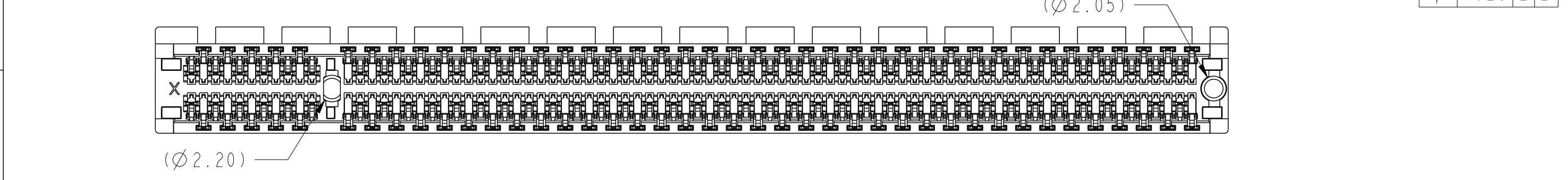
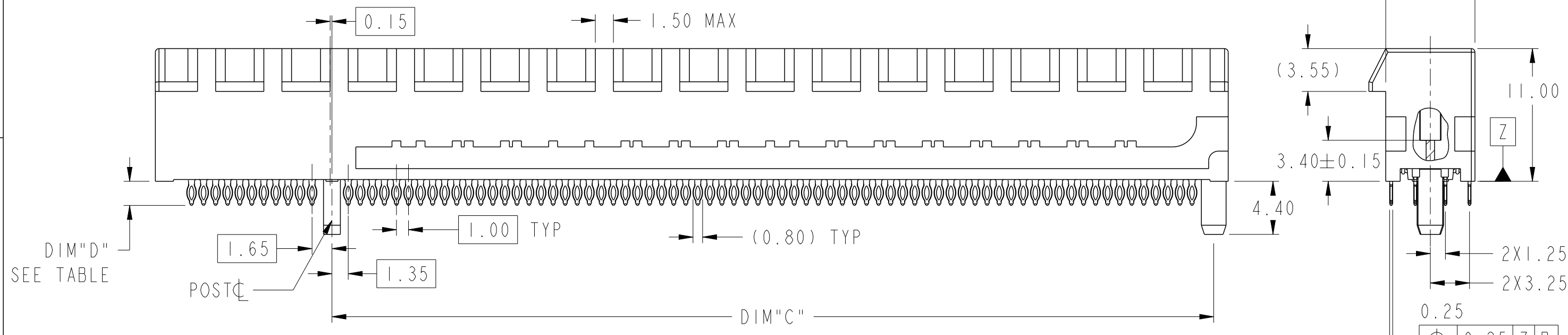
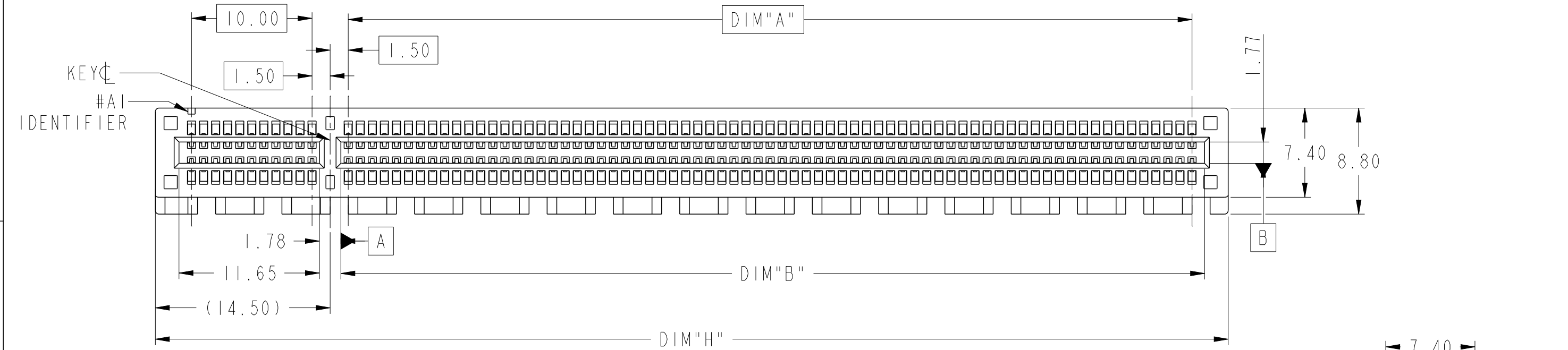

| | | | | | | | | | | | |
|---------------------------------------|---------------------|--|--------------|------------|----------------|------------------------|--------------|---------------|-------|-----|---|
| spec ref | - | dr | Sandar Soe | 2017/10/25 | projection | mm | size | A3 | scale | 1:1 | |
| tolerance std | ISO 406 ISO 1101 | eng | Sandar Soe | 2021/11/25 | | | ecn no | ELX-S-42352-1 | | | |
| TOLERANCES UNLESS OTHERWISE SPECIFIED | | chr | - | - | | | rel level | Released | | | |
| surface | linear | appr | Koon-Poh Tay | 2021/12/17 | product family | - | dwg no | 10145445 | | rev | B |
| ISO 1302 | angular | Amphenol FCI PCIE GEN4, PRESS-FIT MODULE ASSY | | cat. no. | - | Product - Customer Drw | sheet 1 of 4 | | | | |
| | 0.X | ±0.3 | | | | | | | | | |
| | 0.XX | ±0.20 | | | | | | | | | |
| | 0.XXX | ±0.1 | | | | | | | | | |
| | 0° | ±2° | | | | | | | | | |

Amphenol FCI

© 2020 Amphenol Corporation

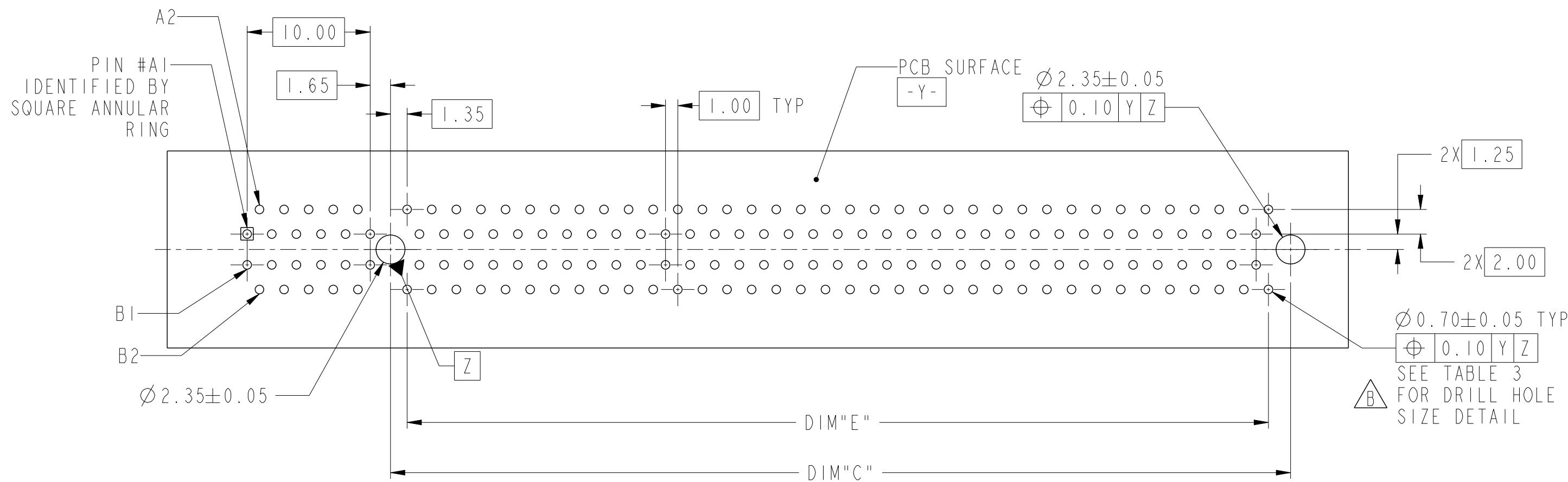

RECOMMENDED PCB LAYOUT

← I/O PANEL DIRECTION

| DIMENSIONS | | | | | |
|------------|-------|-------|-------|-------|-------|
| POSITION | A | B | C | E | H |
| 36 | 6.00 | 7.65 | 9.15 | 6.00 | 25.00 |
| 64 | 20.00 | 21.65 | 23.15 | 20.00 | 39.00 |
| 98 | 37.00 | 38.65 | 40.15 | 37.00 | 56.00 |
| 164 | 70.00 | 71.65 | 73.15 | 70.00 | 89.00 |

TABLE : 1

| | | | | | | | | | | | |
|---------------------------------------|---------------------|------|--------------|-----------------|-------------------------------------|----|------------------------|---------------|--------------|-----|---|
| spec ref | - | dr | Sandar Soe | 2017/10/25 | projection | mm | size | A3 | scale | 1:1 | |
| tolerance std | ISO 406 ISO 1101 | eng | Sandar Soe | 2021/11/25 | | | ecn no | ELX-S-42352-1 | | | |
| TOLERANCES UNLESS OTHERWISE SPECIFIED | | chr | - | - | | | rel level | Released | | | |
| surface | linear | appr | Koon-Poh Tay | 2021/12/17 | product family | - | dwg no | 10145445 | | rev | B |
| ISO 1302 | angular | | | Amphenol FCi | PCIE GEN4, PRESS-FIT MODULE ASSY | | Product - Customer Drw | | sheet 2 of 4 | | |
| | | | | | cat. no. | - | | | | | |

| CONNECTOR LINK WIDTH | POSITION | N | DIM "G" | DIM "F" | PIN "L" |
|----------------------|----------|----|---------|---------|---------|
| X1 | 36 | 6 | 8.15 | 6.00 | B17 |
| X4 | 64 | 20 | 22.15 | 20.00 | B31 |
| X8 | 98 | 37 | 39.15 | 37.00 | B48 |
| X16 | 164 | 70 | 72.15 | 70.00 | B81 |

TABLE : 2

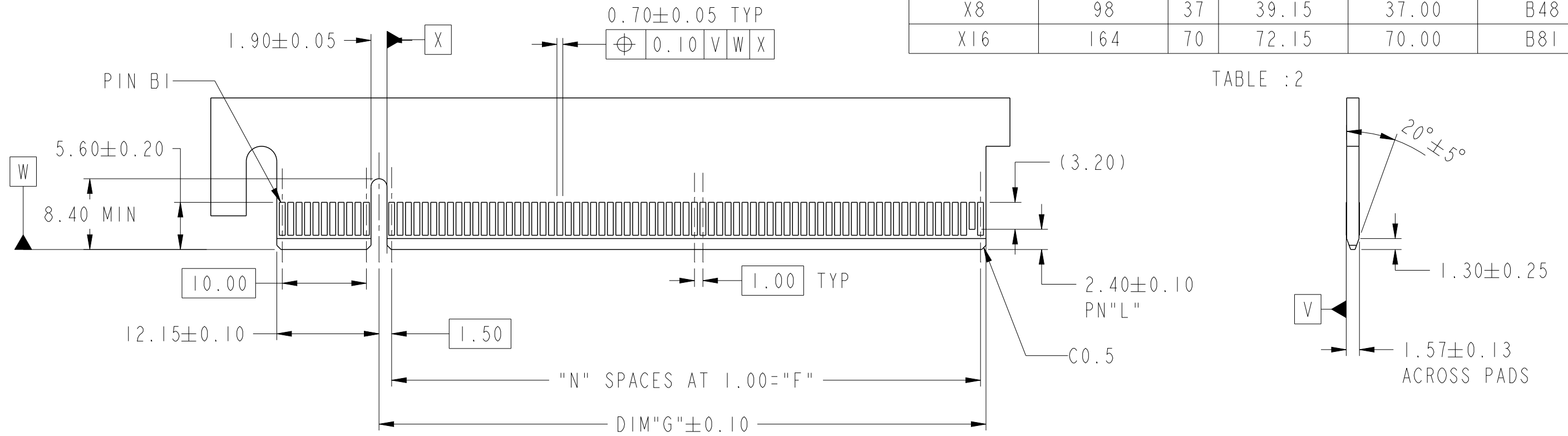

← I/O PANEL DIRECTION
PRIMARY (COMPONENT) SIDE

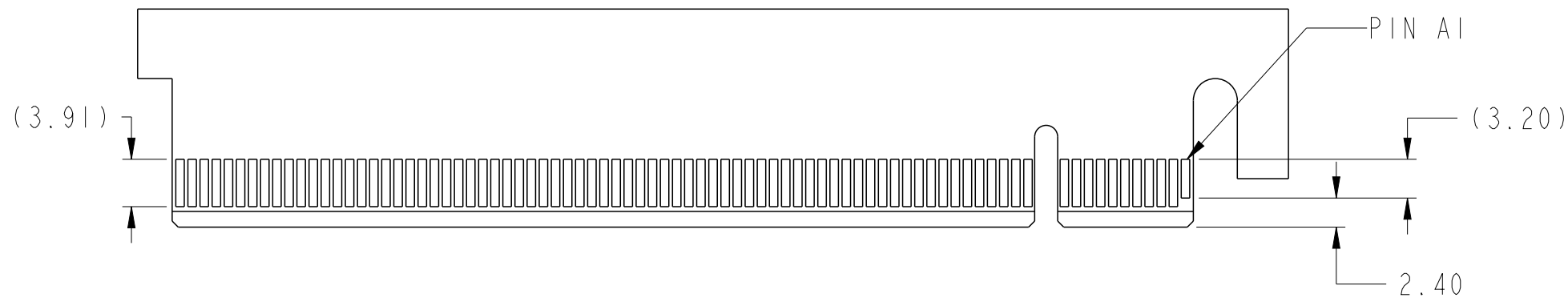

I/O PANEL DIRECTION →
SECONDARY (COMPONENT) SIDE

| | | | | | | | | | | | |
|---------------------------------------|---------------------|------|--------------|---------------------|----------------------|----|-----------------------|------------------------|--------------|-----|--|
| spec ref | - | dr | Sandar Soe | 2017/10/25 | projection | mm | size | A3 | scale | 1:1 | |
| tolerance std | ISO 406 ISO 1101 | eng | Sandar Soe | 2021/11/25 | | | ecn no | ELX-S-42352-1 | | | |
| TOLERANCES UNLESS OTHERWISE SPECIFIED | | chr | - | - | | | | rel level | Released | | |
| surface | linear | 0.X | ±0.3 | Amphenol FCI | product family | | dwg no | 10145445 | | rev | |
| | | 0.XX | ±0.20 | | PCIE GEN4, PRESS-FIT | | | Product - Customer Drw | sheet 3 of 4 | | |
| | angular | 0° | ±2° | | MODULE ASSY | | | | B | | |
| ISO 1302 | | appr | Koon-Poh Tay | 2021/12/17 | cat. no. | - | Printed: Dec 17, 2021 | | | | |

PRODUCT NUMBER CODE

10145445-□□□□□LF

HOUSING COLOUR OPTIONS

1: BLACK

PEGS OPTION

0: PLASTICS PEGS

CONTACT PLATING OPTIONS

| | |
|---|---|
| 0: 50u" Ni UNDERPLATE 30u" Au CONTACT AREA | 2: 50u" Ni UNDERPLATE 30GXT CONTACT AREA |
| 1: 50u" Ni UNDERPLATE 15u" Au CONTACT AREA | 3: 50u" Ni UNDERPLATE 15GXT CONTACT AREA |

PACKAGING

M: SOFT TRAY WITH KAPTON TAPE
N: SOFT TRAY WITHOUT KAPTON TAPE/CAP 

NO. OF POSITION

0: 36 POS
1: 64 POS
2: 98 POS
3: 164 POS

TAIL LENGTH OPTION

| | DIM "D" | PCB TICKNESS |
|---|---------|--------------|
| 0 | 2.00 | 1.57 |
| 1 | 2.00 | 2.36 |

NOTES:

- MATERIAL:
HOUSING: HIGH PERFORMANCE RESIN, UL94V-0
CONTACT: COPPER ALLOY
PLATING: SEE TABLE
- PRODUCT SPECIFICATION: GS-12-1406
- PRODUCT MEETS EUROPEAN UNION DIRECTIVES AND OTHER COUNTRIES REGULATIONS AS DESCRIBED IN GS-22-008
- DIMENSION APPLIES TO THE TIP OF TERMINAL.
- DATE CODE B PRINTED ON THIS SURFACE.
DATE CODE "MMDDYYL", MMDDYY IS ASSEMBLY DATE.
L IS AFCI PRODUCTION SITE.
- "M" DENOTES MALAYSIA
- THE HOUSING WILL WITHSTAND EXPOSURE TO 260° PEAK TEMPERATURE FOR 10SECONDS IN A CONVECTION, INFRA-RED OR VAPOR PHASE REFLOW OVEN

| TABLE 3: PTH AND PAD SIZES WITH REFERENCE TO COMPLIANT PIN DRILL | | | |
|--|-------|-------|------------------|
| COMPLIANT PIN DRILL | PTH | PAD | COPPER THICKNESS |
| ∅0.80 | ∅0.70 | ∅1.00 | 0.025mm MIN. |

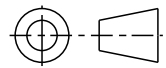
| | | | | | | | | | | | |
|---------------|---------------------|------|--------------|------------|----------------|---|----|----------|---------------|------------------------|--------------|
| spec ref | - | dr | Sandar Soe | 2017/10/25 | projection |  | mm | size | A3 | scale | 1:1 |
| tolerance std | ISO 406 ISO 1101 | eng | Sandar Soe | 2021/11/25 | chr | - | | ecn no | ELX-S-42352-1 | rel level | Released |
| surface | linear | appr | Koon-Poh Tay | 2021/12/17 | product family | - | | dwg no | 10145445 | rev | B |
| | angular | | | | | | | cat. no. | - | Product - Customer Drw | sheet 4 of 4 |
| | | | | | | | | | | | |