



MICROCHIP

**MCP19114 - Flyback
Stand-Alone
Evaluation Board
User's Guide**

Note the following details of the code protection feature on Microchip devices:

- Microchip products meet the specification contained in their particular Microchip Data Sheet.
- Microchip believes that its family of products is one of the most secure families of its kind on the market today, when used in the intended manner and under normal conditions.
- There are dishonest and possibly illegal methods used to breach the code protection feature. All of these methods, to our knowledge, require using the Microchip products in a manner outside the operating specifications contained in Microchip's Data Sheets. Most likely, the person doing so is engaged in theft of intellectual property.
- Microchip is willing to work with the customer who is concerned about the integrity of their code.
- Neither Microchip nor any other semiconductor manufacturer can guarantee the security of their code. Code protection does not mean that we are guaranteeing the product as "unbreakable."

Code protection is constantly evolving. We at Microchip are committed to continuously improving the code protection features of our products. Attempts to break Microchip's code protection feature may be a violation of the Digital Millennium Copyright Act. If such acts allow unauthorized access to your software or other copyrighted work, you may have a right to sue for relief under that Act.

Information contained in this publication regarding device applications and the like is provided only for your convenience and may be superseded by updates. It is your responsibility to ensure that your application meets with your specifications. MICROCHIP MAKES NO REPRESENTATIONS OR WARRANTIES OF ANY KIND WHETHER EXPRESS OR IMPLIED, WRITTEN OR ORAL, STATUTORY OR OTHERWISE, RELATED TO THE INFORMATION, INCLUDING BUT NOT LIMITED TO ITS CONDITION, QUALITY, PERFORMANCE, MERCHANTABILITY OR FITNESS FOR PURPOSE. Microchip disclaims all liability arising from this information and its use. Use of Microchip devices in life support and/or safety applications is entirely at the buyer's risk, and the buyer agrees to defend, indemnify and hold harmless Microchip from any and all damages, claims, suits, or expenses resulting from such use. No licenses are conveyed, implicitly or otherwise, under any Microchip intellectual property rights.

Trademarks

The Microchip name and logo, the Microchip logo, dsPIC, FlashFlex, KEELOQ, KEELOQ logo, MPLAB, PIC, PICmicro, PICSTART, PIC³² logo, rPIC, SST, SST Logo, SuperFlash and UNI/O are registered trademarks of Microchip Technology Incorporated in the U.S.A. and other countries.

FilterLab, Hampshire, HI-TECH C, Linear Active Thermistor, MTP, SEEVAL and The Embedded Control Solutions Company are registered trademarks of Microchip Technology Incorporated in the U.S.A.

Silicon Storage Technology is a registered trademark of Microchip Technology Inc. in other countries.

Analog-for-the-Digital Age, Application Maestro, BodyCom, chipKIT, chipKIT logo, CodeGuard, dsPICDEM, dsPICDEM.net, dsPICworks, dsSPEAK, ECAN, ECONOMONITOR, FanSense, HI-TIDE, In-Circuit Serial Programming, ICSP, Mindi, MiWi, MPASM, MPF, MPLAB Certified logo, MPLIB, MPLINK, mTouch, Omniscent Code Generation, PICC, PICC-18, PICDEM, PICDEM.net, PICkit, PICtail, REAL ICE, rLAB, Select Mode, SQI, Serial Quad I/O, Total Endurance, TSHARC, UniWinDriver, WiperLock, ZENA and Z-Scale are trademarks of Microchip Technology Incorporated in the U.S.A. and other countries.

SQTP is a service mark of Microchip Technology Incorporated in the U.S.A.

GestIC and ULPP are registered trademarks of Microchip Technology Germany II GmbH & Co. KG, a subsidiary of Microchip Technology Inc., in other countries.

All other trademarks mentioned herein are property of their respective companies.

© 2014, Microchip Technology Incorporated, Printed in the U.S.A., All Rights Reserved.

 Printed on recycled paper.

ISBN: 978-1-63276-035-7

**QUALITY MANAGEMENT SYSTEM
CERTIFIED BY DNV
= ISO/TS 16949 =**

Microchip received ISO/TS-16949:2009 certification for its worldwide headquarters, design and wafer fabrication facilities in Chandler and Tempe, Arizona; Gresham, Oregon and design centers in California and India. The Company's quality system processes and procedures are for its PIC[®] MCUs and dsPIC[®] DSCs, KEELOQ[®] code hopping devices, Serial EEPROMs, microperipherals, nonvolatile memory and analog products. In addition, Microchip's quality system for the design and manufacture of development systems is ISO 9001:2000 certified.

**Object of Declaration: MCP19114 - Flyback Stand-Alone Evaluation Board
User's Guide**

EU Declaration of Conformity

This declaration of conformity is issued by the manufacturer.

The development/evaluation tool is designed to be used for research and development in a laboratory environment. This development/evaluation tool is not intended to be a finished appliance, nor is it intended for incorporation into finished appliances that are made commercially available as single functional units to end users. This development/evaluation tool complies with EU EMC Directive 2004/108/EC and as supported by the European Commission's Guide for the EMC Directive 2004/108/EC (8th February 2010).

This development/evaluation tool complies with EU RoHS2 Directive 2011/65/EU.

For information regarding the exclusive, limited warranties applicable to Microchip products, please see Microchip's standard terms and conditions of sale, which are printed on our sales documentation and available at www.microchip.com.

Signed for and on behalf of Microchip Technology Inc. at Chandler, Arizona, USA

Derek Carlson
VP Development Tools

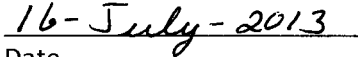
Date

MCP19114 - Flyback Stand-Alone Evaluation Board User's Guide

NOTES:



MCP19114 - FLYBACK STAND-ALONE EVALUATION BOARD USER'S GUIDE

Table of Contents

Preface	7
Introduction.....	7
Document Layout	7
Conventions Used in this Guide	8
Recommended Reading.....	9
The Microchip Web Site	9
Customer Support	9
Document Revision History	9
Chapter 1. Product Overview	
1.1 Introduction	11
1.2 MCP19114 Short Overview	11
1.3 What is the MCP19114 Flyback Stand-Alone Evaluation Board?	12
1.4 MCP19114 Flyback Stand-Alone Evaluation Board Kit Contents	12
Chapter 2. Installation and Operation	
2.1 Introduction	13
2.2 Getting Started	13
Chapter 3. Graphical User Interface (GUI)	
3.1 Introduction	19
3.2 Configuring Parameters	20
Appendix A. Schematic and Layouts	
A.1 Introduction	25
A.2 Board – Schematic	26
A.3 Board – Top Silk	27
A.4 Board – Top Copper and Silk	28
A.5 Board – Top Copper	29
A.6 Board – Inner Plane 1 – GROUND	30
A.7 Board – Inner Plane 2 – POWER	31
A.8 Board – Bottom Copper	32
A.9 Board – Top Copper and Silk	33
A.10 Board – Bottom Silk	34
Appendix B. Bill of Materials (BOM)	
Worldwide Sales and Service	38

MCP19114 - Flyback Stand-Alone Evaluation Board User's Guide

NOTES:

Preface

NOTICE TO CUSTOMERS

All documentation becomes dated, and this manual is no exception. Microchip tools and documentation are constantly evolving to meet customer needs, so some actual dialogs and/or tool descriptions may differ from those in this document. Please refer to our web site (www.microchip.com) to obtain the latest documentation available.

Documents are identified with a “DS” number. This number is located on the bottom of each page, in front of the page number. The numbering convention for the DS number is “DSXXXXA”, where “XXXX” is the document number and “A” is the revision level of the document.

For the most up-to-date information on development tools, see the MPLAB® IDE online help. Select the Help menu, and then Topics to open a list of available online help files.

INTRODUCTION

This chapter contains general information that will be useful to know before using the MCP19114 - Flyback Stand-Alone Evaluation Board. Items discussed in this chapter include:

- Document Layout
- Conventions Used in this Guide
- Recommended Reading
- The Microchip Web Site
- Customer Support
- Document Revision History

DOCUMENT LAYOUT

This document describes how to install the MCP19114 - Flyback Stand-Alone Evaluation Board. It also describes how to operate the Evaluation Board. The manual layout is as follows:

- **Chapter 1. “Product Overview”** – Important information about the MCP19114 - Flyback Stand-Alone Evaluation Board.
- **Chapter 2. “Installation and Operation”** – Includes instructions on how to get started with the MCP19114 - Flyback Stand-Alone Evaluation Board.
- **Chapter 3. “Graphical User Interface (GUI)”** – Includes instructions on the MCP19114-Flyback Standalone GUI.
- **Appendix A. “Schematic and Layouts”** – Shows the schematic and layout diagrams for the MCP19114 - Flyback Stand-Alone Evaluation Board.
- **Appendix B. “Bill of Materials (BOM)”** – Lists the parts used to build the MCP19114 - Flyback Stand-Alone Evaluation Board.

MCP19114 - Flyback Stand-Alone Evaluation Board User's Guide

CONVENTIONS USED IN THIS GUIDE

This manual uses the following documentation conventions:

DOCUMENTATION CONVENTIONS

Description	Represents	Examples
Arial font:		
Italic characters	Referenced books	<i>MPLAB[®] IDE User's Guide</i>
	Emphasized text	...is the <i>only</i> compiler...
Initial caps	A window	the Output window
	A dialog	the Settings dialog
	A menu selection	select Enable Programmer
Quotes	A field name in a window or dialog	"Save project before build"
Underlined, italic text with right angle bracket	A menu path	<u><i>File>Save</i></u>
Bold characters	A dialog button	Click OK
	A tab	Click the Power tab
N'Rnnnn	A number in verilog format, where N is the total number of digits, R is the radix and n is a digit.	4'b0010, 2'hF1
Text in angle brackets < >	A key on the keyboard	Press <Enter>, <F1>
Courier New font:		
Plain Courier New	Sample source code	#define START
	Filenames	autoexec.bat
	File paths	c:\mcc18\h
	Keywords	_asm, _endasm, static
	Command-line options	-Opa+, -Opa-
	Bit values	0, 1
	Constants	0xFF, 'A'
Italic Courier New	A variable argument	<i>file.o</i> , where <i>file</i> can be any valid filename
Square brackets []	Optional arguments	mcc18 [options] <i>file</i> [options]
Curly brackets and pipe character: { }	Choice of mutually exclusive arguments; an OR selection	errorlevel {0 1}
Ellipses...	Replaces repeated text	var_name [, var_name...]
	Represents code supplied by user	void main (void) { ... }

RECOMMENDED READING

This user's guide describes how to use MCP19114 - Flyback Stand-Alone Evaluation Board. Other useful documents are listed below. The following Microchip documents are available and recommended as supplemental reference resources.

- **MCP19114/5 Data Sheet – “Digitally Enhanced Power Analog Synchronous Low-Side PWM Controller” (DS20005281)**

THE MICROCHIP WEB SITE

Microchip provides online support via our web site at www.microchip.com. This web site is used as a means to make files and information easily available to customers. Accessible by using your favorite Internet browser, the web site contains the following information:

- **Product Support** – Data sheets and errata, application notes and sample programs, design resources, user's guides and hardware support documents, latest software releases and archived software
- **General Technical Support** – Frequently Asked Questions (FAQs), technical support requests, online discussion groups, Microchip consultant program member listing
- **Business of Microchip** – Product selector and ordering guides, latest Microchip press releases, listing of seminars and events, listings of Microchip sales offices, distributors and factory representatives

CUSTOMER SUPPORT

Users of Microchip products can receive assistance through several channels:

- Distributor or Representative
- Local Sales Office
- Field Application Engineer (FAE)
- Technical Support

Customers should contact their distributor, representative or field application engineer (FAE) for support. Local sales offices are also available to help customers. A listing of sales offices and locations is included in the back of this document.

Technical support is available through the web site at:
<http://www.microchip.com/support>.

DOCUMENT REVISION HISTORY

Revision A (March 2014)

- Initial Release of this Document.

MCP19114 - Flyback Stand-Alone Evaluation Board User's Guide

NOTES:

Chapter 1. Product Overview

1.1 INTRODUCTION

This chapter provides an overview of the MCP19114 - Flyback Stand-Alone Evaluation Board and covers the following topics:

- MCP19114 Short Overview
- What is the MCP19114 - Flyback Stand-Alone Evaluation Board?
- MCP19114 - Flyback Stand-Alone Evaluation Board Kit Contents

1.2 MCP19114 SHORT OVERVIEW

The MCP19114 is a highly integrated, mixed-signal, analog pulse width-modulation (PWM) current mode controller with an integrated microcontroller core and offers synchronous or asynchronous operation. Since the MCP19114 device uses traditional analog control circuitry to regulate the output current or voltage, the integration of the PIC[®] Microcontroller mid-range core is used to provide complete customization of the device's operating parameters, protection levels, programmable offset, deadtimes, slope compensation and fault handling procedures.

The MCP19114 has two internal LDOs. A 5V LDO (V_{DD}) provides internal power to all the digital circuitry and can supply limited external power at the V_{DD} pin. A 4V LDO (AV_{DD}) provides power to the internal analog circuitry and supplies the reference voltage to the ADC. This device features synchronous low-side integrated drivers and 4k word non-volatile memory, all in a space-saving 24-pin 4mm x 4mm QFN package.

Finally, to support traditional MOSFETs, pin 18 (V_{DR}) is used to provide input power to the two low-side synchronous gate drivers. The evaluation board is populated with the Microchip TC1240A voltage doubler. Resistor population provides the option of powering V_{DR} with 10V via the TC1240A voltage doubler (R19, R21 populated, R22 not populated) or 5V (R22 populated, R19, R21 not populated) gate-drive capability.

User firmware, including device configuration, is loaded using Microchip's MPLAB X[®] - Integrated Development Environment (IDE). A graphical user's interface (GUI) is used to communicate with and edit operating parameters of the MCP19114. The GUI communicates via I²C[™] using the PICKit[™] Serial Analyzer.

The GUI offers the user the ability to adjust the programmable features available in the MCP19114. The GUI cannot stop the user from uploading incorrect settings to the device. Incorrect settings may have unintended consequences, including, but not limited to, unstable operation, damaging the load, and even damaging of the MCP19114 device. It is the user's responsibility to understand the system effects of the parameters they enter.

MCP19114 - Flyback Stand-Alone Evaluation Board User's Guide

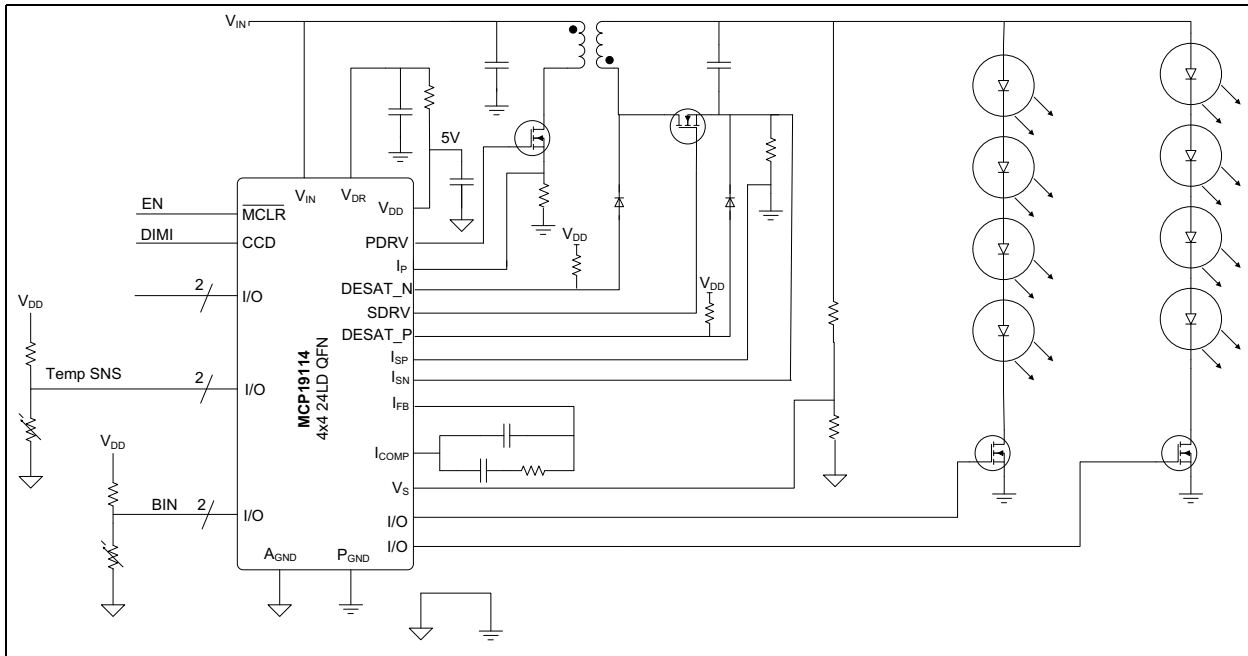

FIGURE 1-1: Typical MCP19114 Flyback Application – Two String LED Driver.

1.3 WHAT IS THE MCP19114 - FLYBACK STAND-ALONE EVALUATION BOARD?

The MCP19114 - Flyback Stand-Alone Evaluation Board is intended to demonstrate how the MCP19114 device operates in a synchronous flyback topology. It is configured to regulate load current and is also well-suited to drive LED loads. Nearly all operational and control system parameters are programmable by utilizing the integrated PIC Microcontroller core.

The MCP19114 comes preprogrammed with firmware designed to operate with the GUI interface. MPLABX IDE software can be used to download user defined firmware, and thus tailoring it to their specific application. The evaluation board contains headers for In-Circuit Serial Programming™ (ICSP) as well as I²C communication.

Several test points have been designed into the printed circuit board for easy access and development purposes. The MCP19114 - Flyback Stand-Alone Evaluation Board is also intended to demonstrate an optimized Printed Circuit Board (PCB) layout that minimizes parasitics while increasing efficiency and power density. Proper PCB layout is critical to achieve optimum MCP19114 operation as well as power train efficiency and noise minimization. MPLABX IDE, MCP19114 - Flyback Stand-Alone GUI and MCP19114 - Flyback Stand-Alone Firmware are available for download from Microchip's web site. See [Chapter 3. "Graphical User Interface \(GUI\)"](#) for details.

1.4 MCP19114 - FLYBACK STAND-ALONE EVALUATION BOARD KIT CONTENTS

The MCP19114 - Flyback Stand-Alone Evaluation Board includes the following items:

- MCP19114 - Flyback Stand-Alone Evaluation Board (ADM00578)
- Important Information Sheet

Chapter 2. Installation and Operation

2.1 INTRODUCTION

2.1.1 MCP19114 - Flyback Stand-Alone Evaluation Board Features

The MCP19114 is a digitally-enhanced, power analog, synchronous low-side pulse-width modulation (PWM) controller. The graphical user interface was developed to assist users in easily configuring the MCP19114 and evaluating it in their target application.

The MCP19114 - Flyback Stand-Alone Evaluation Board is designed to operate from a single supply (nominal 8V to 14V, 24V maximum). The primary side MOSFET has a maximum V_{DS} rating of 100V. Users should be cautious that this 100V rating is not exceeded when determining input and output conditions for their application. The coupled inductor has a 2:1 ratio. The secondary MOSFET has a 200V maximum V_{DS} rating.

The default configuration provides the gate drive supply (V_{DR}) with 10V. Adequate ceramic and bulk capacitors are supplied on the input to reduce the root mean square (RMS) ripple current and lessen input voltage deviation caused by load transients. Ceramic capacitors are also provided on the output to reduce voltage ripple and provide energy to the output while the primary side is being re-energized.

The MCP19114 - Flyback Stand-Alone Evaluation Board is fully assembled, programmed and tested to evaluate and demonstrate the MCP19114 operating performance. Users will need to download and install the MCP19114 - Flyback Stand-Alone GUI from the Microchip website and become familiar with its operation before powering the MCP19114 - Flyback Stand-Alone Evaluation Board.

2.2 GETTING STARTED

2.2.1 Configuration Requirements

To power up and run the MCP19114 - Flyback Stand-Alone Evaluation Board, the following is required:

- MCP19114 - Flyback Stand-Alone GUI
- MCP19114 - Flyback Stand-Alone Evaluation Board
- PICkit Serial Analyzer

Note: The factory-loaded firmware REQUIRES the use of the provided GUI to function. Without the GUI, the evaluation board will not operate.

2.2.2 Installing the MCP19114 - Flyback Stand-Alone GUI

Follow the steps to download and install the MCP19114 - Flyback Stand-Alone GUI:

1. Download the MCP19114 - Flyback Stand-Alone GUI software package from the Microchip web site.
2. Extract the content of the archive files on the computer.
3. Double-click the `setup.exe` file to start software installation. Press the **Install** button in the Application Install window (Figure 2-1). Once the installation completes, the GUI window will open (see Figure 3-1 in Chapter 2. "Installation and Operation").

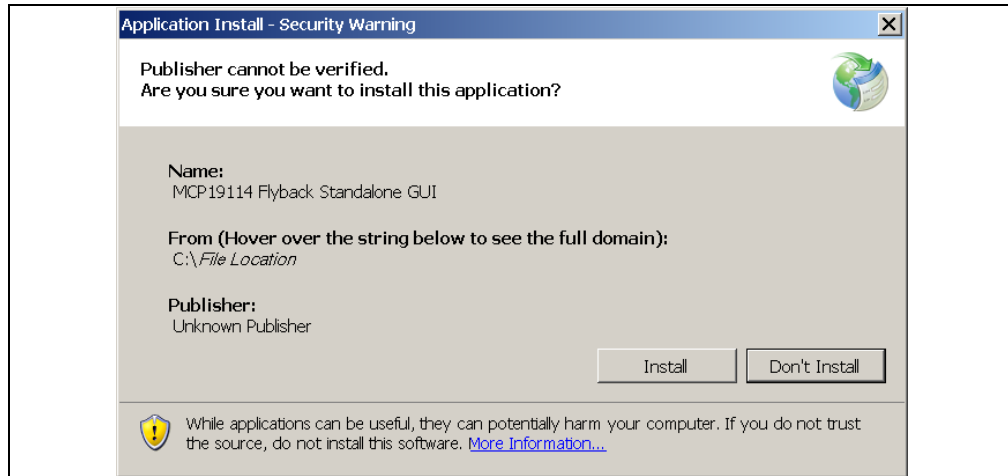

FIGURE 2-1: MCP19114 - Flyback Stand-Alone GUI Installation Window.

2.2.3 Power Input and Output Connection

The MCP19114 comes programmed with generic firmware compatible with the standalone GUI. It is up to the user to modify or create new firmware dedicated to their stand-alone application if different functionality is required.

Note: If the default firmware is modified, the GUI may no longer be compatible with the MCP19114 - Flyback Stand-Alone Evaluation Board.

2.2.3.1 APPLYING POWER

Use the V_{IN} and GND Test Points as shown below. Nominal V_{IN} is +8V to +14V with the Positive terminal (Red) connected to V_{IN} and the Negative terminal (Black) connected to GND.

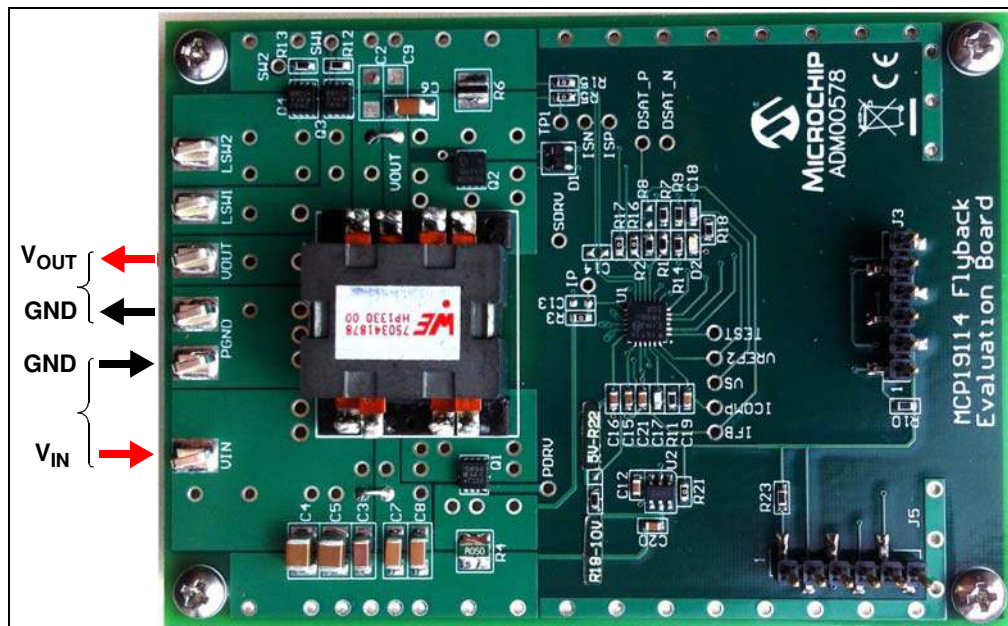

FIGURE 2-2: Applying Power to the Board.

CAUTION

The Primary side MOSFET is Rated to 100V. The transformer turns ratio is 1:2. Do Not exceed the 100V MOSFET Rating. Primary MOSFET (OFF) $V_{DS} = 0.5 \times V_{OUT} + V_{IN}$.

2.2.4 Preprogrammed MCP19114 - Flyback Stand-Alone Evaluation Board

The MCP19114 - Flyback Stand-Alone Evaluation Board comes with preprogrammed firmware installed to operate with the GUI. To reprogram the device, the following tools are required:

- MPLAB X IDE (version 1.5 or later)
- MPLAB® XC8 C Compiler (v1.3 or later)
- MCP19114 - Flyback Stand-Alone Firmware
- MCP19114 - Flyback Stand-Alone Evaluation Board
- PICKit™ 3 In-Circuit Debugger/Programmer

Follow the steps to install all necessary software and start reprogramming the MCP19114 device:

1. If MPLAB X is already installed, go to Step 2. If not, download MPLAB X from: www.microchip.com/mplabx, and follow the MPLAB X installation instructions.
2. If an XC8 compatible C-compiler, or an equivalent, is already installed in MPLAB X, go to Step 3. If not, you can download a free version of Microchip's XC8 from: www.microchip.com/mplabxc. The XC8 user guide, installation instructions, and download links are available on this page.
3. Download the MCP19114 - Flyback Stand-Alone Firmware (*.zip) from www.microchip.com/mcp19114 under "Documentation & Software/Software".
4. Unzip the MCP19114 - Flyback Stand-Alone Firmware archive. Place the MCP19114 project folder in the desired folder location.

Note: When installed, MPLAB X IDE automatically creates a project folder. In Windows®, this folder can typically be found under `drive\Users\user_name\MPLABXProjects`.

5. Power up the MCP19114 - Flyback Stand-Alone Evaluation Board.
6. Connect the PICKit 3 In-Circuit Debugger to the MCP19114 - Flyback Stand-Alone Evaluation Board via the 6-pin connector J3, as seen in [Figure 2-3](#) (for more information about PICKit 3 In-Circuit Debugger refer to the "*PICKit™ 3 In-Circuit Debugger/Programmer User's Guide For MPLAB® X IDE*" - DS52116).



FIGURE 2-3: PICkit 3 In-Circuit Debugger/Programmer Connected to the MCP19114 - Flyback Stand-Alone Evaluation Board.

7. Open MPLAB X IDE to load MCP19114 - Flyback Stand-Alone Firmware. From the File menu select Open Project (Figure 2-4).

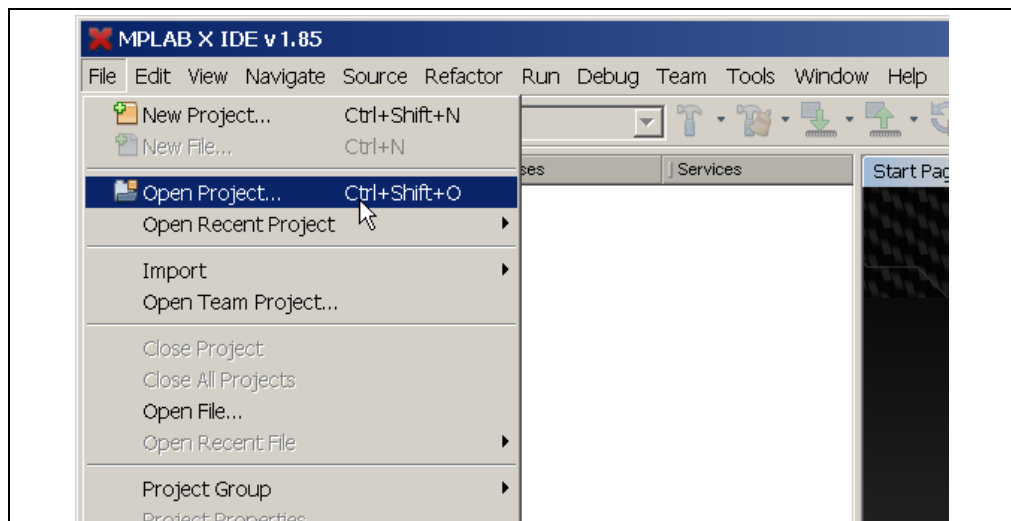

FIGURE 2-4: Opening Project in MPLAB X IDE.

Installation and Operation

- Browse for the location of the extracted firmware. Select the `MCP19114_Stand_Alone` from the list, then check the `Open as Main Project` option. Press the **Open Project** button to complete loading the file.

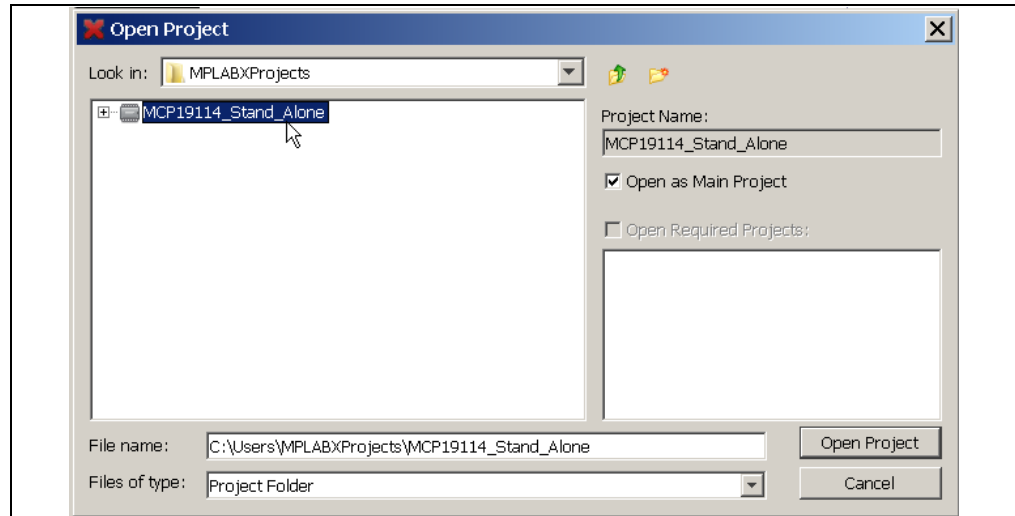

FIGURE 2-5: Loading Firmware into MPLAB X IDE.

- Once the project is opened, click **Make and Program Device Main Project** button on the tool bar to program the device. Wait until the program process is complete.

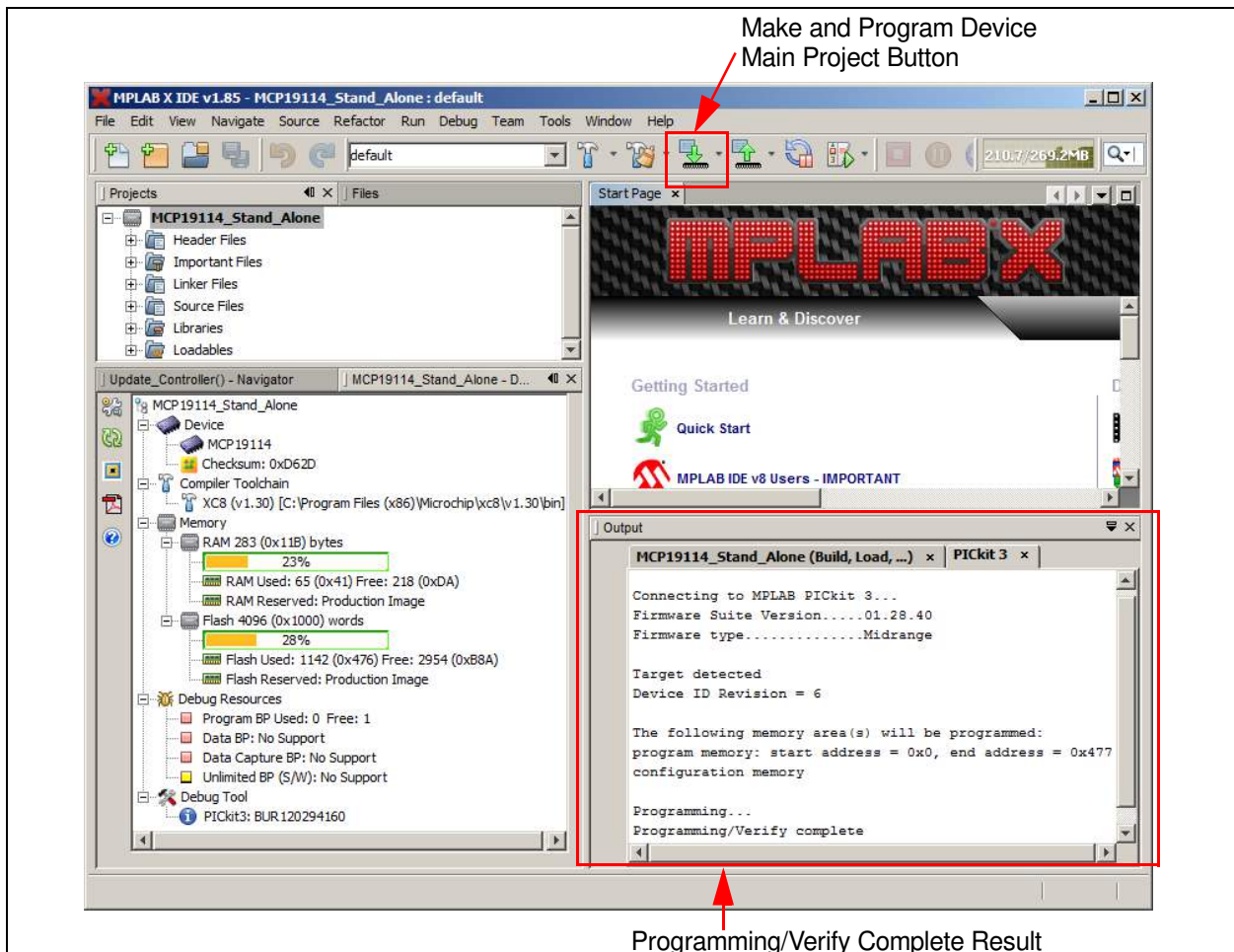

FIGURE 2-6: Selecting and Executing the Make and Program Device Main Project in MPLAB X IDE.

MCP19114 - Flyback Stand-Alone Evaluation Board User's Guide

NOTES:

Chapter 3. Graphical User Interface (GUI)

3.1 INTRODUCTION

The MCP19114 - Flyback Stand-Alone GUI requires a Windows® XP/7/8 operating system, a USB port and a minimum screen resolution of 1024 x 768. To run the software, follow the steps described in this section.

1. Apply an input voltage in the normal operating range (8V to 14V) at the V_{IN} and Ground test points.
2. Connect the PICKit Serial Analyzer to the PC via USB port and then connect the analyzer to the Control Board via the 6-pin serial connector J5 ([Figure 3-1](#)).



FIGURE 3-1: PICKit Serial Analyzer Connection to the Board.

3. To start the GUI, select *Start > All Programs > Microchip Technology Inc. > MCP19114 Flyback Standalone GUI*. The interface detects the MCP19114 device automatically and is ready for use (see [Figure 3-2](#)).

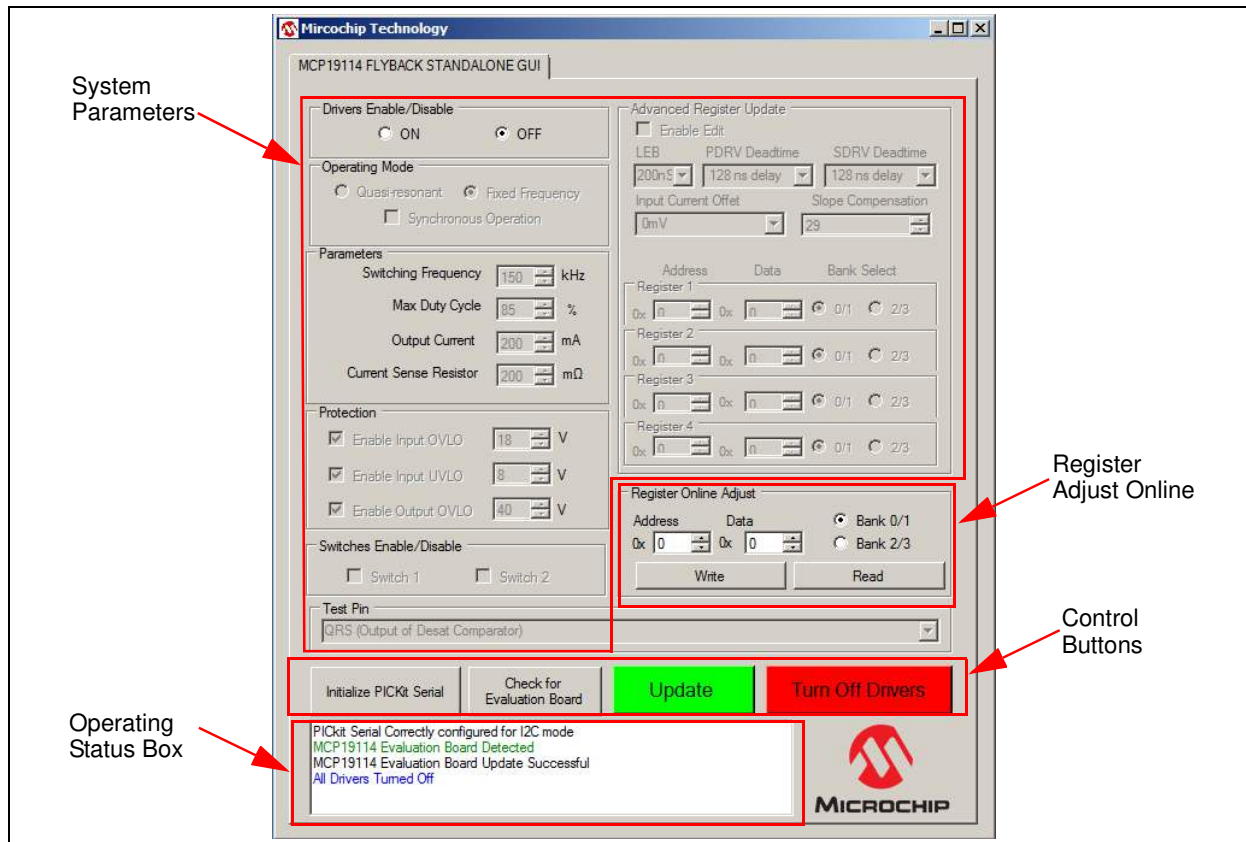

FIGURE 3-2: MCP19114 - Flyback Stand-Alone GUI - Initial Screen.

3.2 CONFIGURING PARAMETERS

As depicted in Figure 3-2, the MCP19114 - Flyback Stand-Alone GUI is divided into four parts:

- System Parameters
- Register Online Adjust
- Control Buttons
- Operating Status Box

3.2.1 System Parameters

3.2.1.1 DRIVERS ENABLE/DISABLE

The Drivers Enable/Disable section defaults to OFF when starting the MCP19114 - Flyback Stand-Alone GUI. When this is set to ON, all other adjustable parameters become active for adjustment. When OFF is selected, the GUI will turn off the drivers and make all of the parameters unavailable for change so they cannot be altered.

3.2.1.2 PARAMETERS

This section controls the Switching Frequency, Maximum Duty Cycle, Output Current and Current Sense Resistor parameters. The switching frequency is user programmable in Fixed Frequency mode over the range of 60 kHz to 1 MHz. Switching Frequency can be adjusted in 10 kHz intervals. The maximum duty cycle is programmable from 0 to 100%.

CAUTION

Increasing switching frequency results in increased switching losses in the MOSFETs. It is the user's responsibility to ensure MOSFETs are operated within their safe operating range.

Users can adjust the Output Current over a range of 0 to 500 mA. The Current Sense Resistor (R6) value on the MCP19114 - Flyback Stand-Alone Evaluation Board is 200 mΩ. Both of these values are used to calculate the set point value written to the VREFCON register. *DO NOT* raise the resistor value in the GUI without changing the resistor on the evaluation board to match. Failure to do so could result in damage to the evaluation board.

Note: Attempting to write a value larger than 0xFF to VREFCON is prohibited by the GUI.

3.2.1.3 OPERATING MODE

This section controls whether the Flyback converter is operated in Fixed-Frequency, Quasi-Resonant, Synchronous or Asynchronous Modes. When running in Fixed Frequency mode, the switching frequency parameters are adjustable. The third button is for Synchronous Operation. When the EN ON button is selected on the GUI, the Synchronous Operation box is automatically selected by default, putting the evaluation board in Synchronous mode. If the Synchronous Operation box is unchecked, the evaluation board is set to Asynchronous operation which disables the secondary driver (SDRV).

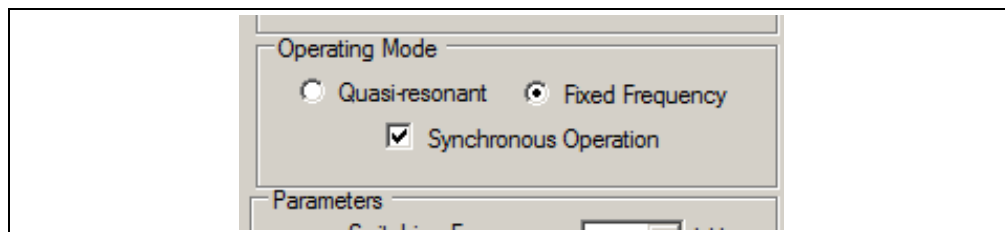

FIGURE 3-3: Operating Mode Options.

3.2.1.4 PROTECTION

The Protection control allows the user to set levels for the three adjustable protection features. Input Voltage Under Voltage Lockout (VIUVLO), Input Voltage Overvoltage Lockout (VINOVLO) and Output Voltage Overvoltage (OV) can all be configured in this section of the GUI.

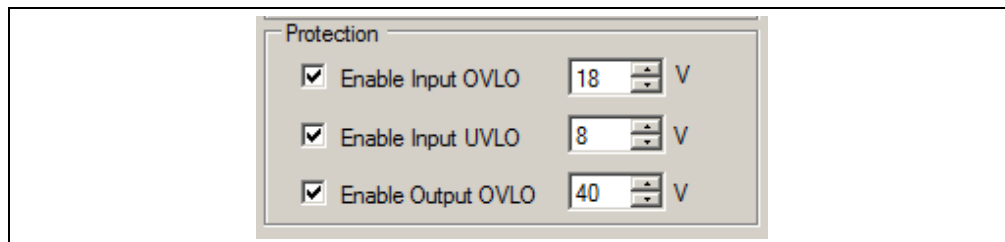

FIGURE 3-4: Protection Options.

MCP19114 - Flyback Stand-Alone Evaluation Board User's Guide

The VINUVLO and VINOVLO Protection parameters are configurable per their specified ranges. The specified range for VINUVLO is 4V to 20V. The default VINUVLO setting in the GUI is 8V. The specified VINOVLO range is 9V to 24V. The default VINOVLO setting in the GUI is 18V. The Output OV has a configurable range between 0V and 60V. The default OV setting in the GUI is 40V.

The LED (D2) on the evaluation board is used to indicate various fault conditions. The firmware will flash this LED to indicate each of the following fault conditions:

- **VIN UVLO FAULT:** Short Flash Routine
- **VIN OVLO FAULT:** Long Flash Routine
- **OUTPUT OV FAULT:** Short/Long Flash Routine

WARNING

Use caution when changing from these default settings to ensure that damage will not occur. The VINUVLO, VINOVLO and Output OV controls adjust the VINUVLO, VINOVLO and OVREFCON registers, respectively.

3.2.1.5 TEST PIN

This section of the GUI has a drop-down menu that allows users to select and connect test signals to GPIO GPA0. These signals are accessible at the test point labeled TEST. The Test Pin can be configured to output several analog or digital parameters. See [Figure 3-5](#) for the list of signals.

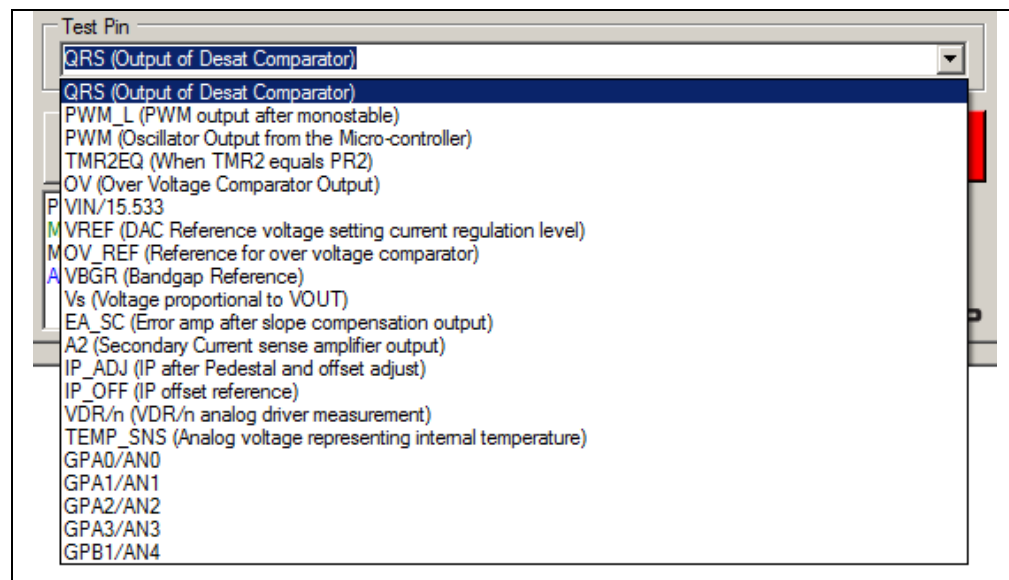

FIGURE 3-5: Test Pin Options.

3.2.1.6 SWITCHES ENABLE/DISABLE

There are two general purpose MOSFET low-side series switches located on MCP19114 - Flyback Stand-Alone Evaluation Board (LSW1 and LSW2). The control boxes in the Switches Enable/Disable section of the GUI allow the user to turn these switches ON (checked) and OFF (unchecked).

Graphical User Interface (GUI)

3.2.1.7 ADVANCED REGISTER UPDATE

This section of GUI gives the user more options to configure and operate the MCP19114 - Flyback Stand-Alone Evaluation Board. The adjustable parameters include Leading Edge Blanking (LEB), Primary Driver (PDRV) Deadtime, Secondary Driver (SDRV) Deadtime, Input Current Offset and Slope Compensation. In addition, this section allows users to update up to four Special Function Registers (SFR) at the same time. For more information on Special Function Registers, refer to the MCP19114/5 Data Sheet – “Digitally Enhanced Power Analog Synchronous Low-Side PWM Controller” (DS20005281).

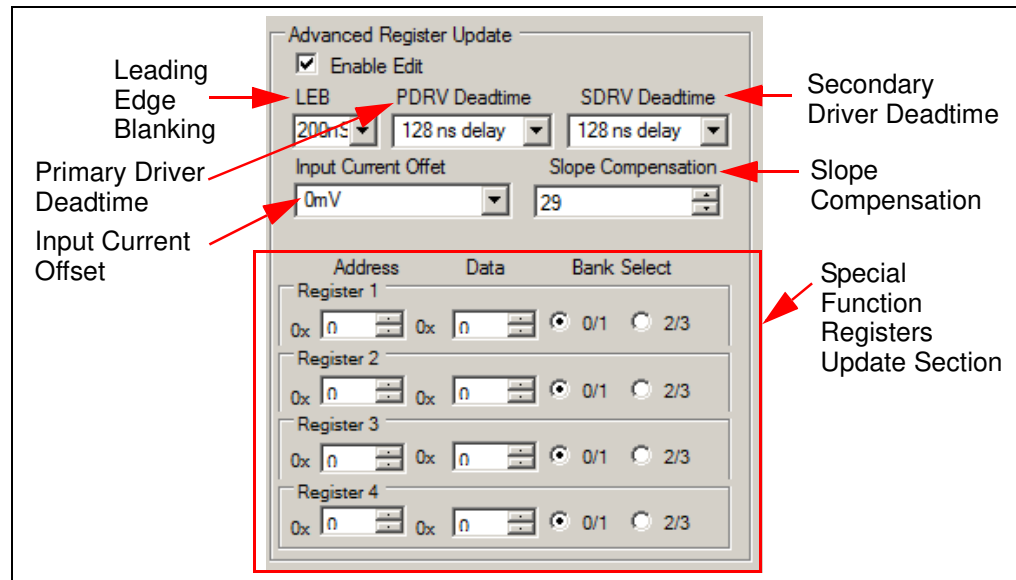

FIGURE 3-6: Advanced Register Update Options.

3.2.2 Register Online Adjust

The Register Online Adjust section of the GUI allows the user to have direct control of register values at any time when operating the MCP19114. The device data sheet contains information on register address locations and content. Reads and writes are done in hexadecimal format. Users must select the proper bank, which is especially important when executing a write. It is good practice to always execute an address read before a write, to check for expected results. This may help prevent an unintended write to an improper address or bank. Please note that the **Update** button will not update this section.

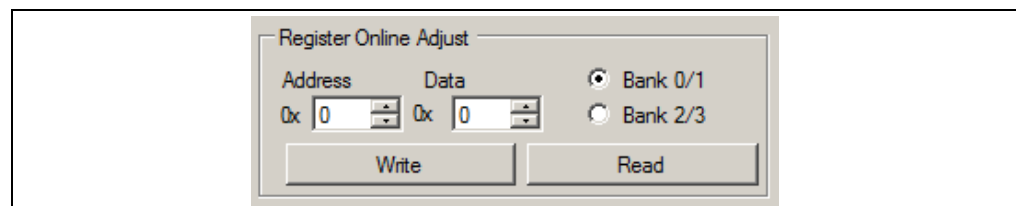

FIGURE 3-7: Register Online Adjust Options.

3.2.3 Control Buttons

The two buttons on the left are user selectable self-test options. The **Initialize PICKit Serial** button checks communication between your computer and PICKit Serial Analyzer. The **Check for Evaluation Board** can be selected by the user to manually ask software to detect the evaluation board.

The **Update** button will apply the configuration settings made in Operating Mode, Parameters, Protection, Switches Enable/Disable, Advanced Register Update and will turn on the output drivers. It will **not** update the Register Online Adjust section.

The Turn Off Drivers button is a Master Stop that shuts off the output drivers. Pressing this button will disable both Primary and Secondary drivers.

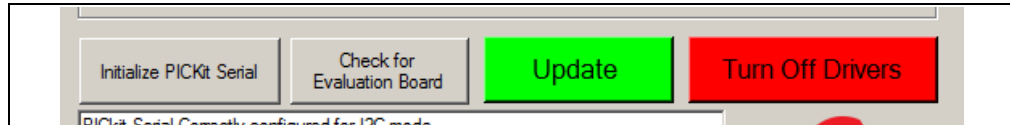

FIGURE 3-8: Control Buttons.

3.2.4 Operating Status Box

This box provides messages to the user and operating status. Examples of status messages are shown in [Figure 3-9](#).

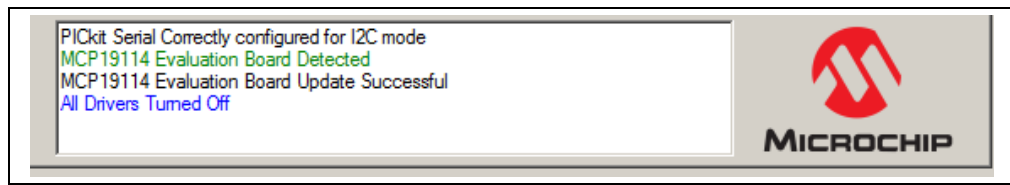

FIGURE 3-9: Operating Status Box.



MCP19114 - FLYBACK STAND-ALONE EVALUATION BOARD USER'S GUIDE

Appendix A. Schematic and Layouts

A.1 INTRODUCTION

This appendix contains the following schematics and layouts for the MCP19114 - Flyback Stand-Alone Evaluation Board:

- Board – Schematic
- Board – Top Layer
- Board – Top Copper
- Board – Mid Layer 1
- Board – Mid Layer 2
- Board – Bottom Copper
- Board – Bottom Layer

A.2 BOARD - SCHEMATIC

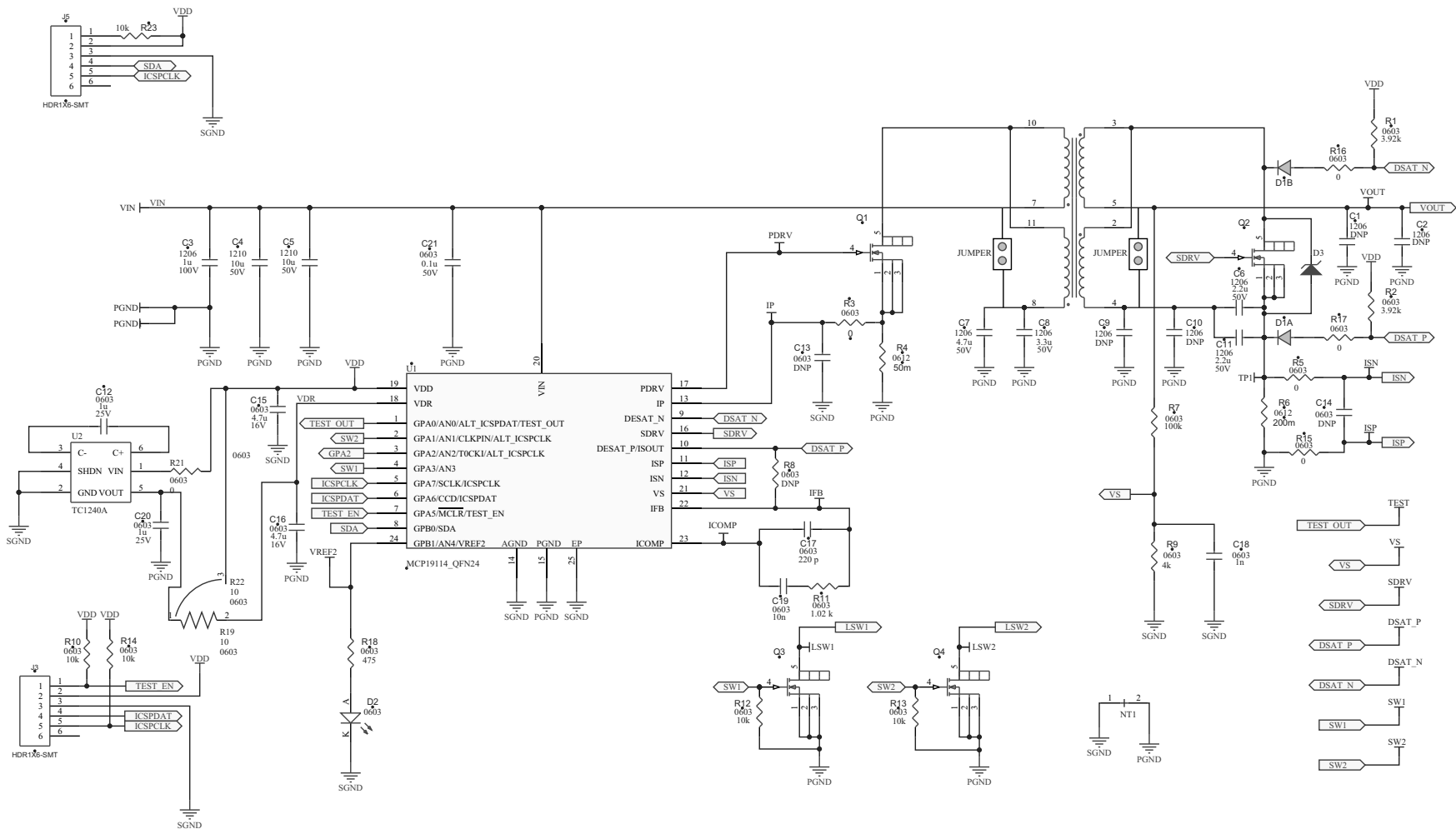

A.3 BOARD – TOP LAYER

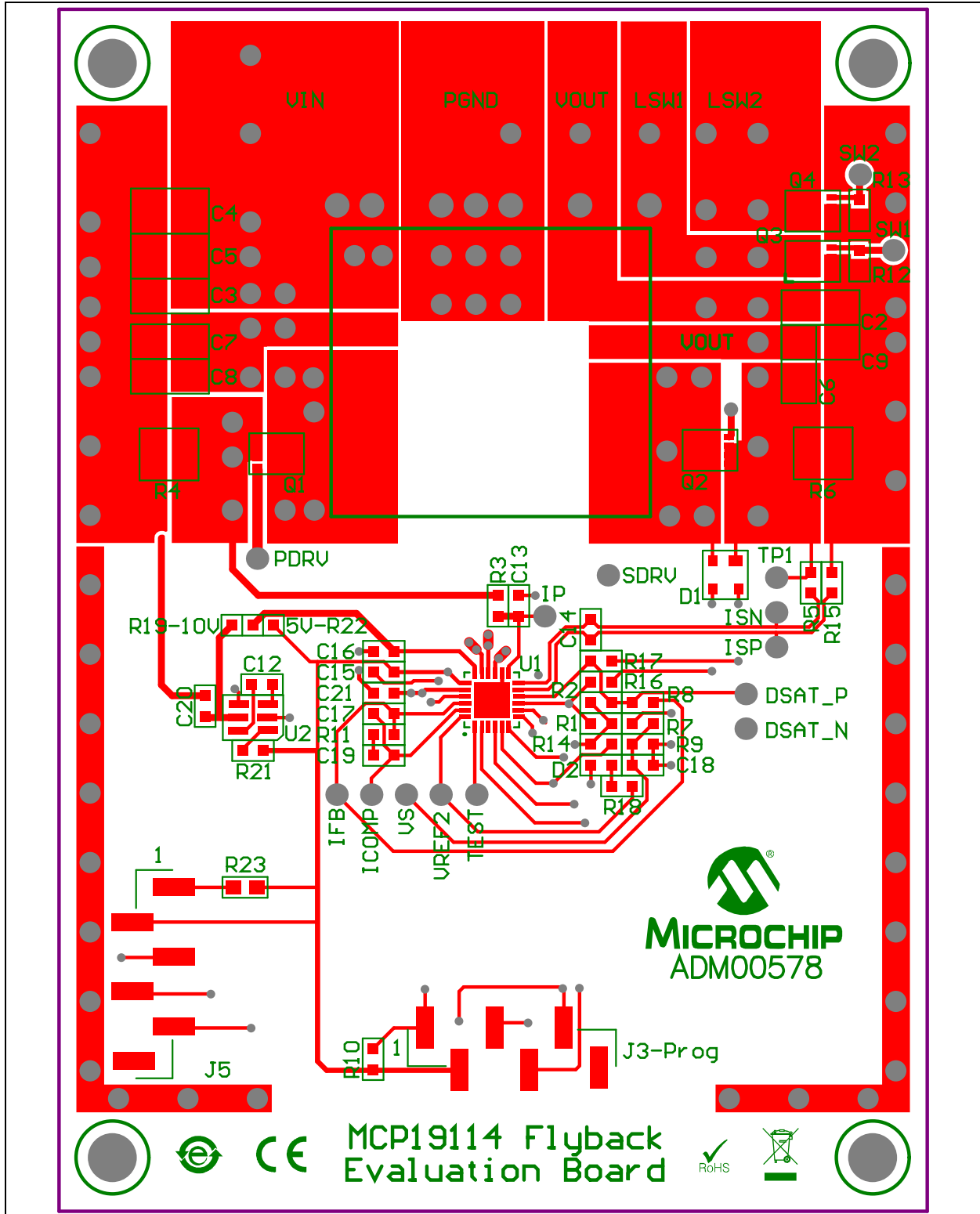

A.4 BOARD – TOP COPPER

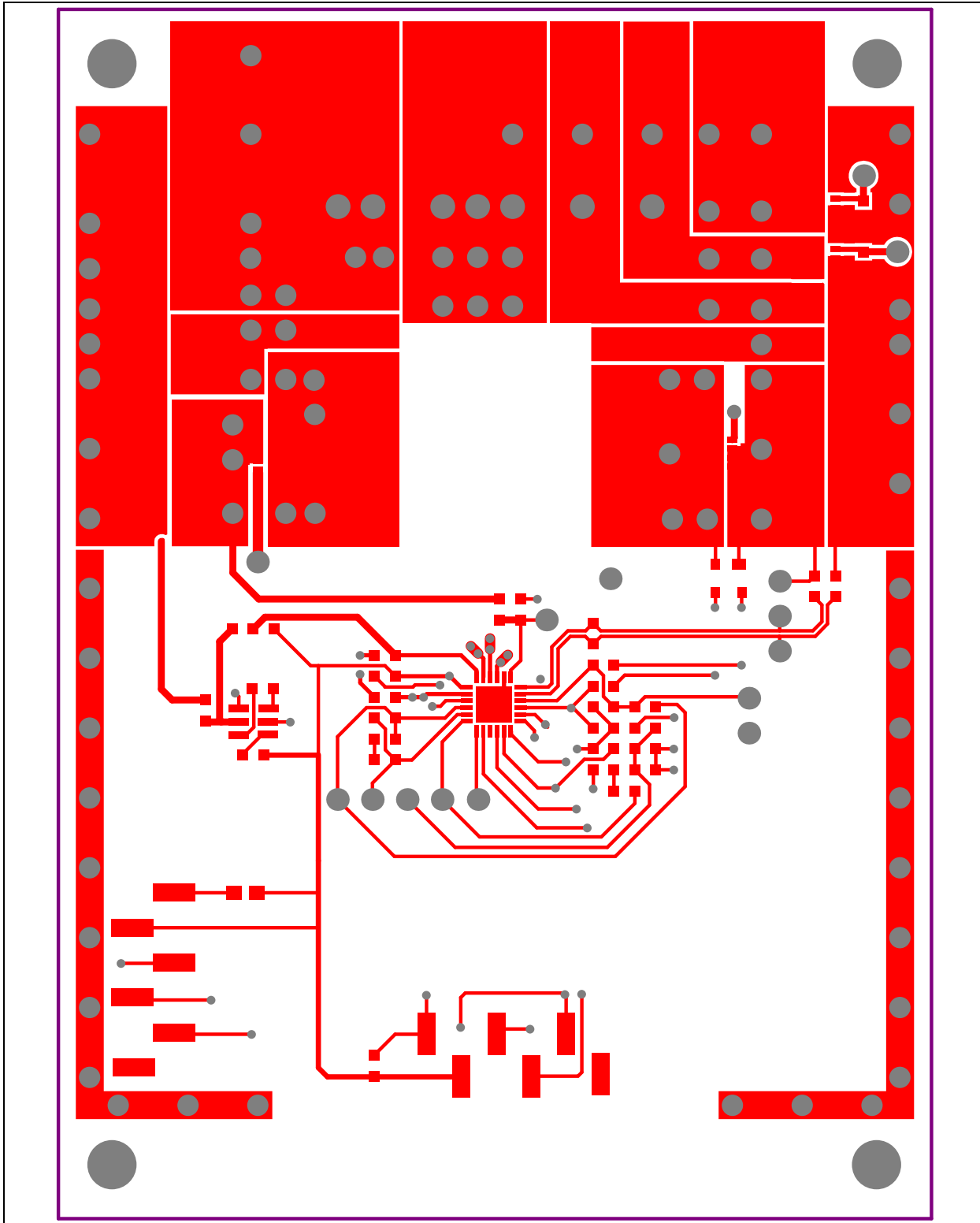

A.5 BOARD – MID LAYER 1

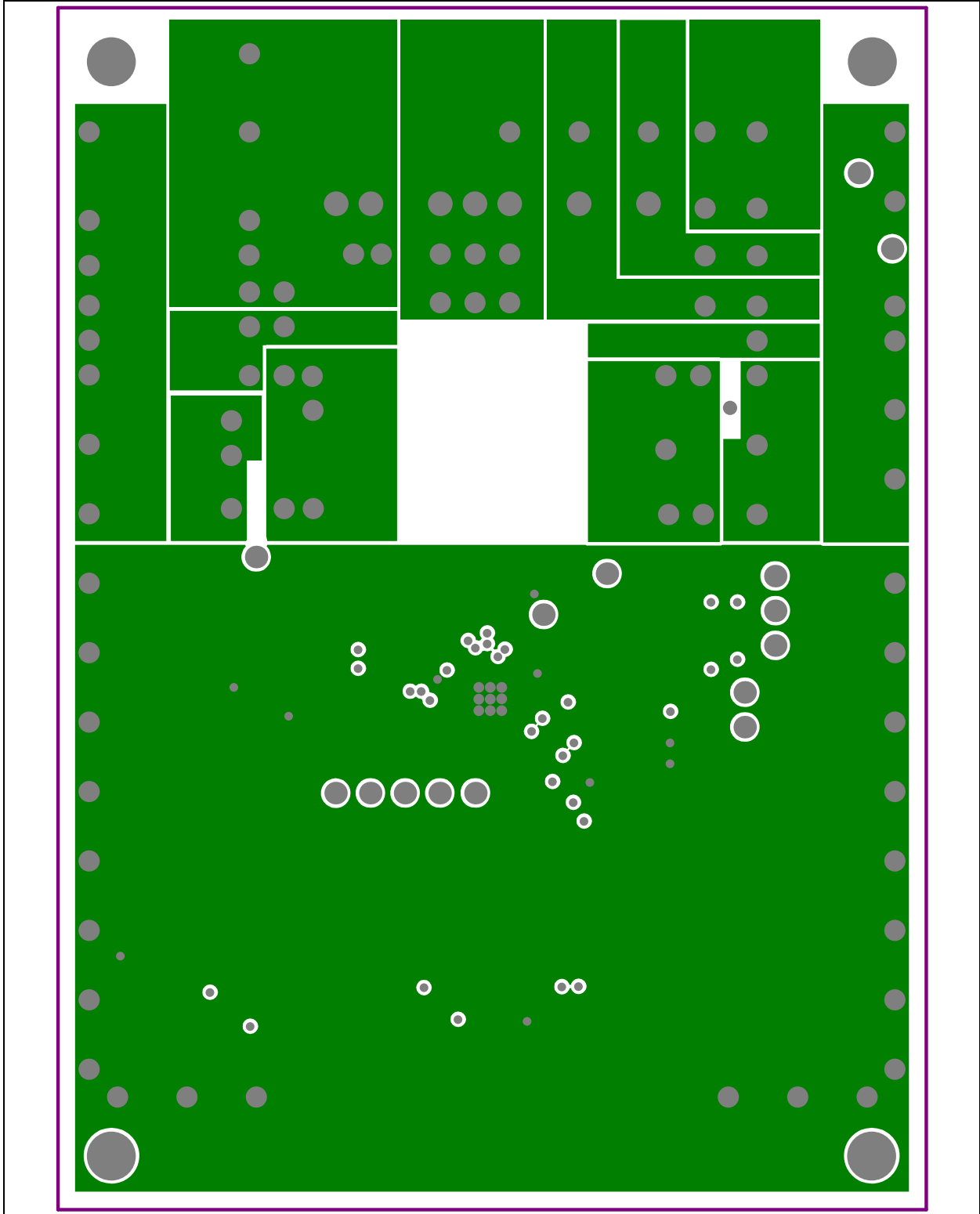

A.6 BOARD – MID LAYER 2

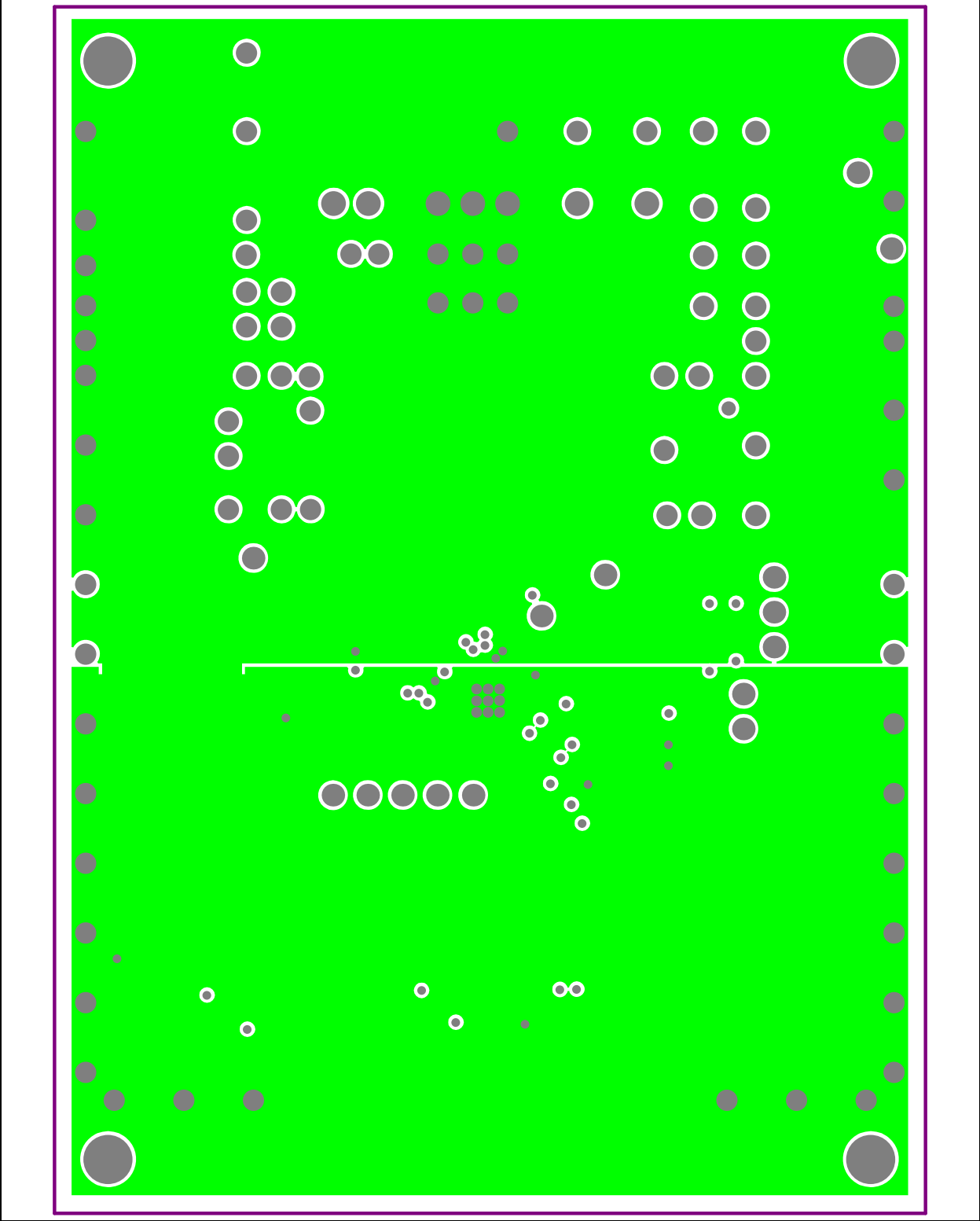

A.7 BOARD – BOTTOM COPPER

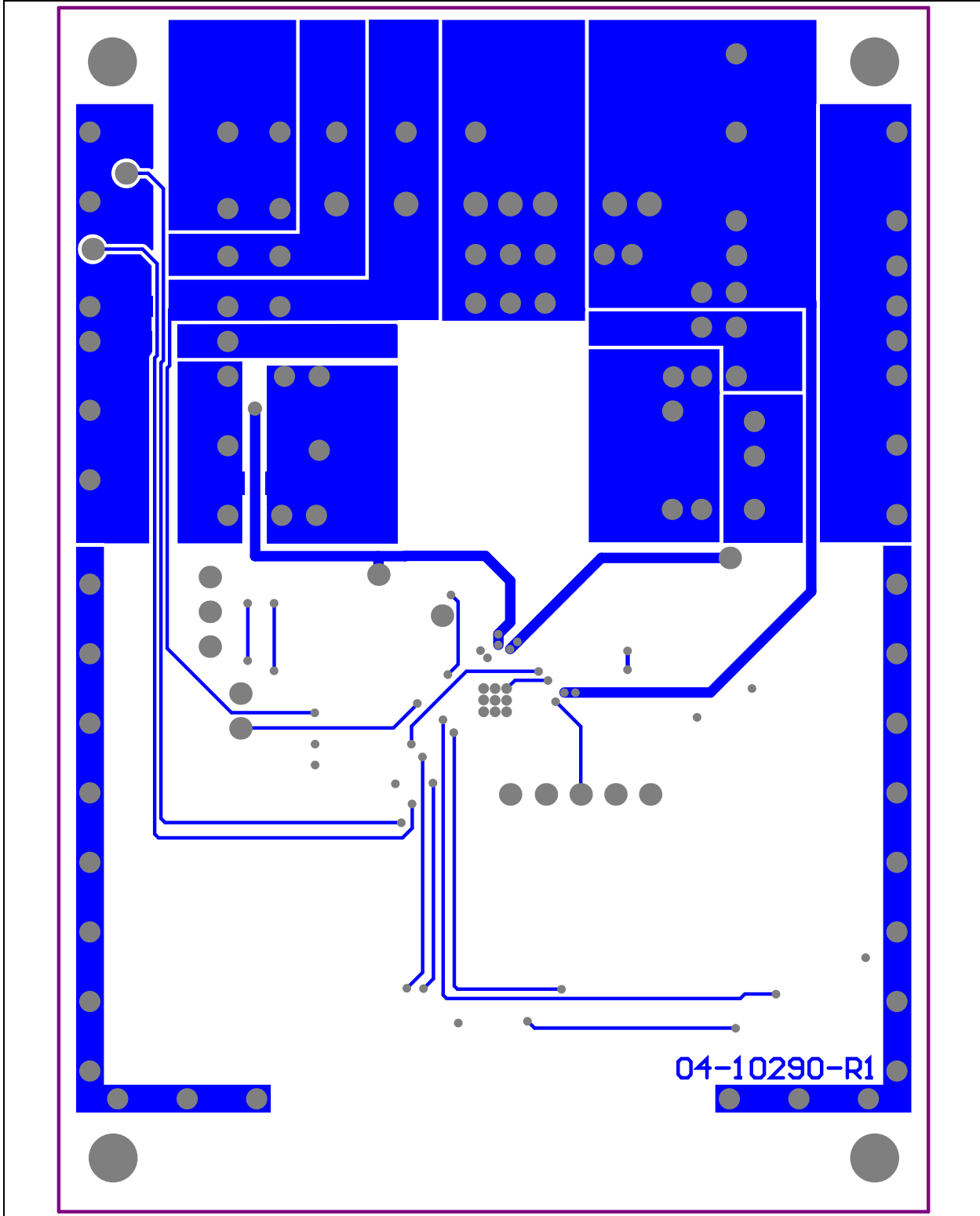

A.8 BOARD – BOTTOM LAYER

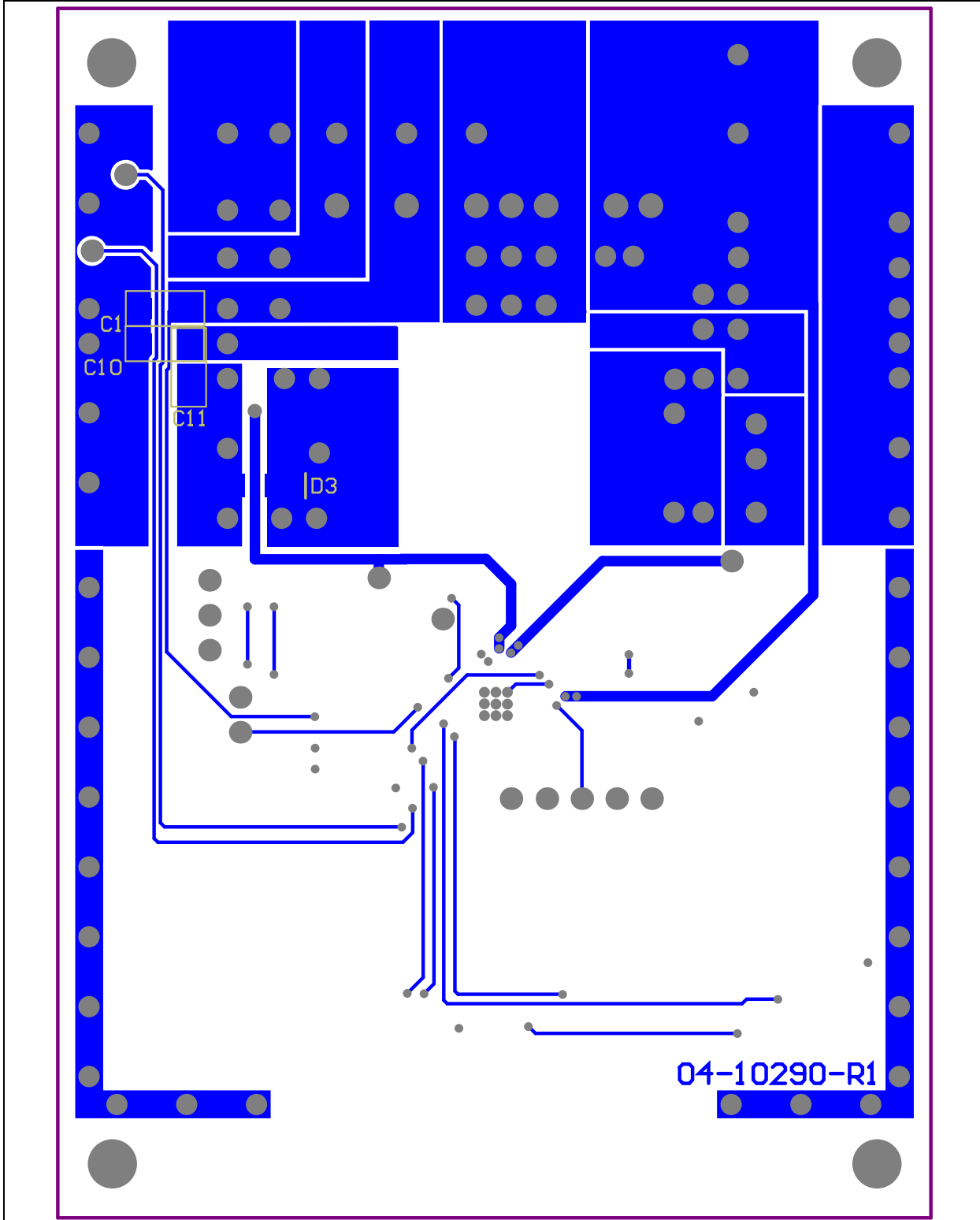

Appendix B. Bill of Materials (BOM)

TABLE 2-1: BILL OF MATERIALS (BOM)

Qty.	Reference	Description	Manufacturer	Part Number
4	4-40 screw	Machine screw 4-40 1/4	B&F™ Fasteners Supply	PMSSS 440 0025 PH
4	4-40 standoff 1/4	Hex standoff 4-40 aluminum 1/4	Keystone Electronics	2201
4	C1, C2, C9, C10	DO NOT POPULATE	—	—
1	C3	Cap.ceramic 1 μF, 100V, X7R, Auto 1206	TDK Corporation	CGA5L2X7R2A105M/SOFT
2	C4, C5	Cap.ceramic 10 μF, 50V, X7R, Auto 1210	Taiyo Yuden Co., Ltd.	UMK325AB7106MM-T
2	C6, C11	Cap.ceramic 2.2 μF, 50V, X7R, Auto 1206	TDK Corporation	CGA5L3X7R1H225K
1	C7	Cap.ceramic 4.7 μF, 50V, X7R, Auto 1206	TDK Corporation	C3216X7R1H475K160AC
1	C8	Cap.ceramic 3.3 μF, 50V, X7R, Auto 1206	TDK Corporation	C3216X7R1H335K160AC
2	C12, C20	Cap. ceramic 1 μF, 25V, X7R, Auto 0603	TDK Corporation	CGA3E1X7R1E105K
2	C13, C14	DO NOT POPULATE	—	—
2	C15, C16	Cap.ceramic 4.7 μF, 16V, X5R, Auto 0603	TDK Corporation	C1608X5R1C475K
1	C17	Cap. ceramic 220 pF, 50V, COG 0603	Murata Electronics®	GCM1885C1H221JA16D
1	C18	Cap. ceramic 1 nF, 50V, COG 0603	Murata Electronics®	GCM1885C1H102JA16D
1	C19	Cap. ceramic 10 nF 50V 10% X7R 0603	TDK Corporation	C1608X7R1H103K080AA
1	C21	Cap.ceramic 0.1 μF, 50V, X7R, Auto 0603	TDK Corporation	CGA3E2X7R1H104K
1	D1A, D1B	Diode SW DBL 200V 225 mA SOT143B	NXP Semiconductor	BAV23, 215"
1	D2	LED, super red, clear 0603	Lite-On® Technology Corporation	LTST-C190KRKT
1	D3	TVS diode 90 VWM 146 VC SMA Uni-Dir	Littelfuse®	SMAJ90A
2	J3, J5	Header, 6 Pos., 2.54 mm, SMT, vert., gold	Samtec, Inc.	TSM-106-01-L-SV
1	PCB	Printed Circuit Board - MCP19114 - Flyback Stand-Alone Evaluation Board	—	04-10290
3	Q1, Q3, Q4	N-Channel MOSFET, 100V	Vishay Intertechnology, Inc.	SIS890DN-T1-GE3
1	Q2	MOSFET N-Ch. 200V 15.2A 8TSDSON	Infineon Technologies AG	BSZ900N20NS3 G
2	R1, R2	Res. 3.92 kΩ 1/10th Watt, 1% 0603 SMD	Panasonic® - ECG	ERJ-3EKF3921V
6	R3, R5, R15, R16, R17, R21	Res. 0.0Ω 1/10W 0603 SMD	Panasonic - ECG	ERJ-3GEY0R00V
1	R4	Res. 50 mΩ 1 Watt, 1% 0612 SMD	Susumu Co., LTD.	PRL1632-R050-F-T1
1	R6	Res. 200 mΩ 1 Watt, 1% 0612 SMD	Rohm Semiconductor	LTR18EZPFLR200
1	R7	Res. 100 kΩ 1/10th Watt, 1% 0603 SMD	Panasonic - ECG	ERJ-3EKF1003V
1	R8	DO NOT POPULATE	—	—
1	R9	Res. 4.02 kΩ 1/10th Watt, 1% 0603 SMD	Panasonic - ECG	ERJ-3EKF4021V

Note 1: The components listed in this Bill of Materials are representative of the PCB assembly. The released BOM used in manufacturing uses all RoHS-compliant components.

MCP19114 - Flyback Stand-Alone Evaluation Board User's Guide

TABLE 2-1: BILL OF MATERIALS (BOM) (CONTINUED)

Qty.	Reference	Description	Manufacturer	Part Number
4	R10, R12, R13, R14	Res. 10 k Ω 1/10th Watt, 1% 0603 SMD	Panasonic - ECG	ERJ-3EKF1002V
1	R11	Res. 1.02 k Ω 1/10th Watt, 1% 0603 SMD	Panasonic - ECG	ERJ-3EKF1021V
1	R18	Res. 475 Ω 1/10th Watt, 1% 0603 SMD	Panasonic - ECG	ERJ-3EKF4750V
1	R19	Res. 10.0 Ω 1/10W 1% 0603 SMD	Panasonic - ECG	ERJ-3EKF10R0V
1	R22	DO NOT POPULATE	—	—
1	R23	Res. 10 k Ω 1/10th Watt, 1% 0603 SMD	Panasonic - ECG	ERJ-3EKF1002V
1	T1	Uni-Cuk Transformer 1:2	Würth® Group	750341878
1	U1	Digitally Enhanced PWM Power Analog Controller	Microchip Technology Inc.	MCP19114-E/MJ
1	U2	Charge Pump, Doubler	Microchip Technology Inc.	TC1240A-E/CH
6	VIN, PGND, PGND1, VOUT, LSW1, LSW2	Test point PC compact SMT	Keystone Electronics Corp.	5016

Note 1: The components listed in this Bill of Materials are representative of the PCB assembly. The released BOM used in manufacturing uses all RoHS-compliant components.

Bill of Materials (BOM)

NOTES:



MICROCHIP

Worldwide Sales and Service

AMERICAS

Corporate Office
2355 West Chandler Blvd.
Chandler, AZ 85224-6199
Tel: 480-792-7200
Fax: 480-792-7277
Technical Support:
<http://www.microchip.com/support>
Web Address:
www.microchip.com

Atlanta
Duluth, GA
Tel: 678-957-9614
Fax: 678-957-1455

Austin, TX
Tel: 512-257-3370

Boston
Westborough, MA
Tel: 774-760-0087
Fax: 774-760-0088

Chicago
Itasca, IL
Tel: 630-285-0071
Fax: 630-285-0075

Cleveland
Independence, OH
Tel: 216-447-0464
Fax: 216-447-0643

Dallas
Addison, TX
Tel: 972-818-7423
Fax: 972-818-2924

Detroit
Novi, MI
Tel: 248-848-4000

Houston, TX
Tel: 281-894-5983

Indianapolis
Noblesville, IN
Tel: 317-773-8323
Fax: 317-773-5453

Los Angeles
Mission Viejo, CA
Tel: 949-462-9523
Fax: 949-462-9608

New York, NY
Tel: 631-435-6000

San Jose, CA
Tel: 408-735-9110

Canada - Toronto
Tel: 905-673-0699
Fax: 905-673-6509

ASIA/PACIFIC

Asia Pacific Office
Suites 3707-14, 37th Floor
Tower 6, The Gateway
Harbour City, Kowloon
Hong Kong
Tel: 852-2401-1200
Fax: 852-2401-3431

Australia - Sydney
Tel: 61-2-9868-6733
Fax: 61-2-9868-6755

China - Beijing
Tel: 86-10-8569-7000
Fax: 86-10-8528-2104

China - Chengdu
Tel: 86-28-8665-5511
Fax: 86-28-8665-7889

China - Chongqing
Tel: 86-23-8980-9588
Fax: 86-23-8980-9500

China - Hangzhou
Tel: 86-571-8792-8115
Fax: 86-571-8792-8116

China - Hong Kong SAR
Tel: 852-2401-1200
Fax: 852-2401-3431

China - Nanjing
Tel: 86-25-8473-2460
Fax: 86-25-8473-2470

China - Qingdao
Tel: 86-532-8502-7355
Fax: 86-532-8502-7205

China - Shanghai
Tel: 86-21-5407-5533
Fax: 86-21-5407-5066

China - Shenyang
Tel: 86-24-2334-2829
Fax: 86-24-2334-2393

China - Shenzhen
Tel: 86-755-8864-2200
Fax: 86-755-8203-1760

China - Wuhan
Tel: 86-27-5980-5300
Fax: 86-27-5980-5118

China - Xian
Tel: 86-29-8833-7252
Fax: 86-29-8833-7256

China - Xiamen
Tel: 86-592-2388138
Fax: 86-592-2388130

China - Zhuhai
Tel: 86-756-3210040
Fax: 86-756-3210049

ASIA/PACIFIC

India - Bangalore
Tel: 91-80-3090-4444
Fax: 91-80-3090-4123

India - New Delhi
Tel: 91-11-4160-8631
Fax: 91-11-4160-8632

India - Pune
Tel: 91-20-3019-1500

Japan - Osaka
Tel: 81-6-6152-7160
Fax: 81-6-6152-9310

Japan - Tokyo
Tel: 81-3-6880-3770
Fax: 81-3-6880-3771

Korea - Daegu
Tel: 82-53-744-4301
Fax: 82-53-744-4302

Korea - Seoul
Tel: 82-2-554-7200
Fax: 82-2-558-5932 or
82-2-558-5934

Malaysia - Kuala Lumpur
Tel: 60-3-6201-9857
Fax: 60-3-6201-9859

Malaysia - Penang
Tel: 60-4-227-8870
Fax: 60-4-227-4068

Philippines - Manila
Tel: 63-2-634-9065
Fax: 63-2-634-9069

Singapore
Tel: 65-6334-8870
Fax: 65-6334-8850

Taiwan - Hsin Chu
Tel: 886-3-5778-366
Fax: 886-3-5770-955

Taiwan - Kaohsiung
Tel: 886-7-213-7830

Taiwan - Taipei
Tel: 886-2-2508-8600
Fax: 886-2-2508-0102

Thailand - Bangkok
Tel: 66-2-694-1351
Fax: 66-2-694-1350

EUROPE

Austria - Wels
Tel: 43-7242-2244-39
Fax: 43-7242-2244-393

Denmark - Copenhagen
Tel: 45-4450-2828
Fax: 45-4485-2829

France - Paris
Tel: 33-1-69-53-63-20
Fax: 33-1-69-30-90-79

Germany - Dusseldorf
Tel: 49-2129-3766400

Germany - Munich
Tel: 49-89-627-144-0
Fax: 49-89-627-144-44

Germany - Pforzheim
Tel: 49-7231-424750

Italy - Milan
Tel: 39-0331-742611
Fax: 39-0331-466781

Italy - Venice
Tel: 39-049-7625286

Netherlands - Drunen
Tel: 31-416-690399
Fax: 31-416-690340

Poland - Warsaw
Tel: 48-22-3325737

Spain - Madrid
Tel: 34-91-708-08-90
Fax: 34-91-708-08-91

Sweden - Stockholm
Tel: 46-8-5090-4654

UK - Wokingham
Tel: 44-118-921-5800
Fax: 44-118-921-5820

03/21/14