

Highly insulated module with Trench/Fieldstop IGBT3 and emitter controlled 3 diode

Features

- Electrical features
 - $V_{CES} = 4500\text{ V}$
 - $I_{C\text{ nom}} = 1000\text{ A} / I_{CRM} = 2000\text{ A}$
 - High DC stability
 - High dynamic robustness
 - High short-circuit capability
 - Low $V_{CE,sat}$
 - Trench IGBT 3
 - $V_{CE,sat}$ with positive temperature coefficient
- Mechanical features
 - ALSiC base plate for increased thermal cycling capability
 - High creepage and clearance distances
 - Isolated base plate
 - Package with CTI > 600
 - Package with enhanced insulation of 10.4 kV AC 60 s



Potential applications

- Motor drives
- Traction drives
- Multi-level inverter
- High-power converters
- Medium-voltage converters

Product validation

- Qualified for industrial applications according to the relevant tests of IEC 60747, 60749 and 60068

Description

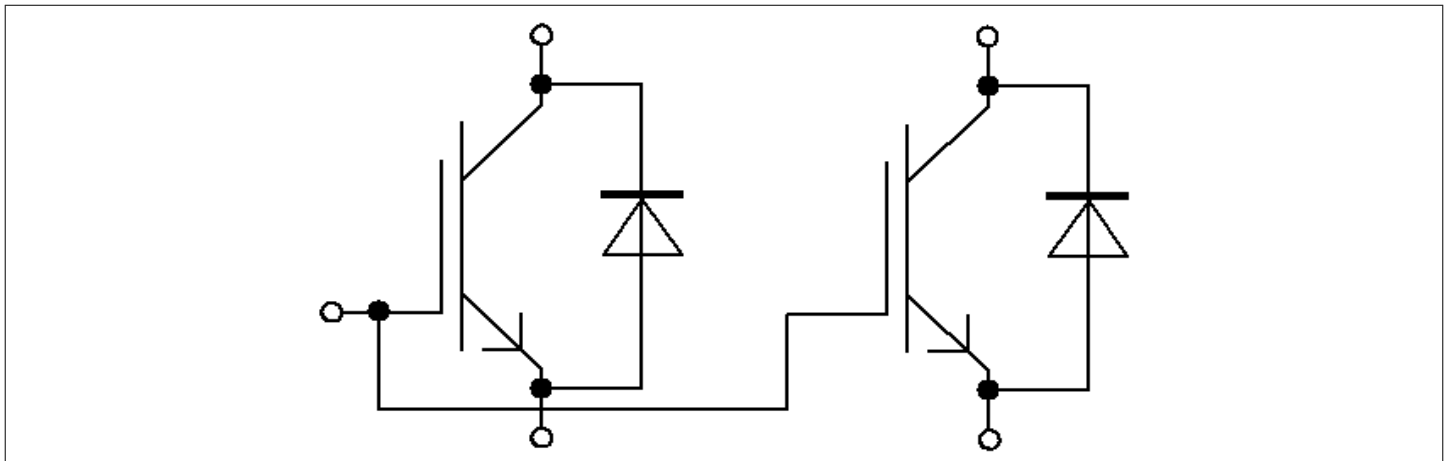

Table of contents

| | | |
|----------|---------------------------------------|----|
| | Description | 1 |
| | Features | 1 |
| | Potential applications | 1 |
| | Product validation | 1 |
| | Table of contents | 2 |
| 1 | Package | 3 |
| 2 | IGBT, Inverter | 3 |
| 3 | Diode, Inverter | 5 |
| 4 | Characteristics diagrams | 7 |
| 5 | Circuit diagram | 11 |
| 6 | Package outlines | 12 |
| 7 | Module label code | 13 |
| | Revision history | 14 |
| | Disclaimer | 15 |

1 Package

Table 1 Insulation coordination

| Parameter | Symbol | Note or test condition | Values | Unit |
|--------------------------------------|-------------|--|--------|------|
| Isolation test voltage | V_{ISOL} | RMS, $f = 50 \text{ Hz}$, $t = 60 \text{ s}$ | 10.4 | kV |
| Partial discharge extinction voltage | V_{isol} | RMS, $f = 50 \text{ Hz}$, $Q_{PD} \leq 10 \text{ pC}$ | 3.5 | kV |
| DC stability | $V_{CE(D)}$ | $T_{vj}=25^{\circ}\text{C}$, 100 Fit | 3000 | V |
| Material of module baseplate | | | AlSiC | |
| Internal isolation | | basic insulation (class 1, IEC 61140) | AlN | |
| Creepage distance | d_{Creep} | terminal to heatsink | 64.0 | mm |
| Creepage distance | d_{Creep} | terminal to terminal | 56.0 | mm |
| Clearance | d_{Clear} | terminal to heatsink | 40.0 | mm |
| Clearance | d_{Clear} | terminal to terminal | 26.0 | mm |
| Comparative tracking index | CTI | | > 600 | |

Table 2 Characteristic values

| Parameter | Symbol | Note or test condition | Values | | | Unit | |
|--|---------------|--|-----------|------|------|------|----|
| | | | Min. | Typ. | Max. | | |
| Stray inductance module | L_{sCE} | | | 20 | | nH | |
| Module lead resistance, terminals - chip | $R_{CC'+EE'}$ | $T_C=25^{\circ}\text{C}$, per switch | | 0.18 | | mΩ | |
| Storage temperature | T_{stg} | | -55 | | 125 | °C | |
| Mounting torque for module mounting | M | - Mounting according to valid application note | M6, Screw | 4.25 | | 5.75 | Nm |
| Terminal connection torque | M | - Mounting according to valid application note | M4, Screw | 1.8 | | 2.1 | Nm |
| | | | M8, Screw | 8 | | 10 | |
| Weight | G | | | 1000 | | g | |

Note: The maximum allowed dv/dt measured between 0,6 and $1 \times V_{ce}$ is $1400\text{V}/\mu\text{s}$.

2 IGBT, Inverter

Table 3 Maximum rated values

| Parameter | Symbol | Note or test condition | Values | Unit |
|---------------------------|-----------|--------------------------------|--------|------|
| Collector-emitter voltage | V_{CES} | $T_{vj} = -40^{\circ}\text{C}$ | 4500 | V |
| | | $T_{vj} = 25^{\circ}\text{C}$ | 4500 | |
| | | $T_{vj} = 125^{\circ}\text{C}$ | 4500 | |

(table continues...)
 Datasheet

Table 3 (continued) Maximum rated values

| Parameter | Symbol | Note or test condition | Values | Unit |
|-----------------------------------|-----------|---|----------|------|
| Continuous DC collector current | I_{CDC} | $T_{vj\ max} = 150\ ^\circ\text{C}$ $T_C = 80\ ^\circ\text{C}$ | 1000 | A |
| Repetitive peak collector current | I_{CRM} | t_p limited by $T_{vj\ op}$ | 2000 | A |
| Gate-emitter peak voltage | V_{GES} | | ± 20 | V |

Table 4 Characteristic values

| Parameter | Symbol | Note or test condition | Values | | | Unit |
|--------------------------------------|---------------|--|--------------------------------|-------|------|---------------|
| | | | Min. | Typ. | Max. | |
| Collector-emitter saturation voltage | $V_{CE\ sat}$ | $I_C = 1000\ \text{A}, V_{GE} = 15\ \text{V}$ | $T_{vj} = 25\ ^\circ\text{C}$ | 2.70 | 3.05 | V |
| | | | $T_{vj} = 125\ ^\circ\text{C}$ | 3.25 | 3.85 | |
| Gate threshold voltage | V_{GETh} | $I_C = 70.5\ \text{mA}, V_{CE} = V_{GE}, T_{vj} = 25\ ^\circ\text{C}$ | 5.40 | 6 | 6.60 | V |
| Gate charge | Q_G | $V_{GE} = \pm 15\ \text{V}, V_{CC} = 2800\ \text{V}$ | | 26.5 | | μC |
| Internal gate resistor | R_{Gint} | $T_{vj} = 25\ ^\circ\text{C}$ | | 1.1 | | Ω |
| Input capacitance | C_{ies} | $f = 1000\ \text{kHz}, T_{vj} = 25\ ^\circ\text{C}, V_{CE} = 25\ \text{V}, V_{GE} = 0\ \text{V}$ | | 185 | | nF |
| Reverse transfer capacitance | C_{res} | $f = 1000\ \text{kHz}, T_{vj} = 25\ ^\circ\text{C}, V_{CE} = 25\ \text{V}, V_{GE} = 0\ \text{V}$ | | 3.1 | | nF |
| Collector-emitter cut-off current | I_{CES} | $V_{CE} = 4500\ \text{V}, V_{GE} = 0\ \text{V}$ $T_{vj} = 25\ ^\circ\text{C}$ | | | 5 | mA |
| Gate-emitter leakage current | I_{GES} | $V_{CE} = 0\ \text{V}, V_{GE} = 20\ \text{V}, T_{vj} = 25\ ^\circ\text{C}$ | | | 400 | nA |
| Turn-on delay time (inductive load) | t_{don} | $I_C = 1000\ \text{A}, V_{CC} = 2800\ \text{V}, V_{GE} = \pm 15\ \text{V}, R_{Gon} = 1\ \Omega$ | $T_{vj} = 25\ ^\circ\text{C}$ | 0.910 | | μs |
| | | | $T_{vj} = 125\ ^\circ\text{C}$ | 0.960 | | |
| Rise time (inductive load) | t_r | $I_C = 1000\ \text{A}, V_{CC} = 2800\ \text{V}, V_{GE} = \pm 15\ \text{V}, R_{Gon} = 1\ \Omega$ | $T_{vj} = 25\ ^\circ\text{C}$ | 0.210 | | μs |
| | | | $T_{vj} = 125\ ^\circ\text{C}$ | 0.230 | | |
| Turn-off delay time (inductive load) | t_{doff} | $I_C = 1000\ \text{A}, V_{CC} = 2800\ \text{V}, V_{GE} = \pm 15\ \text{V}, R_{Goff} = 9.1\ \Omega$ | $T_{vj} = 25\ ^\circ\text{C}$ | 7.150 | | μs |
| | | | $T_{vj} = 125\ ^\circ\text{C}$ | 7.530 | | |
| Fall time (inductive load) | t_f | $I_C = 1000\ \text{A}, V_{CC} = 2800\ \text{V}, V_{GE} = \pm 15\ \text{V}, R_{Goff} = 9.1\ \Omega$ | $T_{vj} = 25\ ^\circ\text{C}$ | 1.100 | | μs |
| | | | $T_{vj} = 125\ ^\circ\text{C}$ | 2.120 | | |
| Turn-on time (resistive load) | t_{on_R} | $I_C = 500\ \text{A}, V_{CC} = 2000\ \text{V}, V_{GE} = \pm 15\ \text{V}, R_{Gon} = 1\ \Omega$ | 1.80 | | | μs |
| Turn-on energy loss per pulse | E_{on} | $I_C = 1000\ \text{A}, V_{CC} = 2800\ \text{V}, L_\sigma = 95\ \text{nH}, V_{GE} = \pm 15\ \text{V}, R_{Gon} = 1\ \Omega, di/dt = 3500\ \text{A}/\mu\text{s} (T_{vj} = 125\ ^\circ\text{C})$ | $T_{vj} = 25\ ^\circ\text{C}$ | 3700 | | mJ |
| | | | $T_{vj} = 125\ ^\circ\text{C}$ | 5400 | | |

(table continues...)

Table 4 (continued) Characteristic values

| Parameter | Symbol | Note or test condition | Values | | | Unit |
|--|------------|---|---|------|------|------------------|
| | | | Min. | Typ. | Max. | |
| Turn-off energy loss per pulse | E_{off} | $I_C = 1000\text{ A}$, $V_{CC} = 2800\text{ V}$, $L_\sigma = 95\text{ nH}$, $V_{GE} = \pm 15\text{ V}$, $R_{Goff} = 9.1\ \Omega$, $dv/dt = 1300\text{ V}/\mu\text{s}$ ($T_{vj} = 125\text{ }^\circ\text{C}$) | $T_{vj} = 25\text{ }^\circ\text{C}$ | 3800 | | mJ |
| | | | $T_{vj} = 125\text{ }^\circ\text{C}$ | 5000 | | |
| SC data | I_{SC} | $V_{GE} \leq 15\text{ V}$, $V_{CC} = 2800\text{ V}$, $V_{CEmax} = V_{CES} - L_{sCE} \cdot di/dt$ | $t_p \leq 10\ \mu\text{s}$, $T_{vj} \leq 125\text{ }^\circ\text{C}$ | 4600 | | A |
| Thermal resistance, junction to case | R_{thJC} | per IGBT | | | 11.1 | K/kW |
| Thermal resistance, case to heat sink | R_{thCH} | per IGBT, $\lambda_{grease} = 1\text{ W}/(\text{m}\cdot\text{K})$ | | 13.5 | | K/kW |
| Temperature under switching conditions | T_{vjop} | | -50 | | 125 | $^\circ\text{C}$ |

3 Diode, Inverter

Table 5 Maximum rated values

| Parameter | Symbol | Note or test condition | Values | Unit | |
|---------------------------------|-------------|---|--------------------------------------|---------------|-----------------------|
| Repetitive peak reverse voltage | V_{RRM} | | $T_{vj} = -40\text{ }^\circ\text{C}$ | 4500 | V |
| | | | $T_{vj} = 25\text{ }^\circ\text{C}$ | 4500 | |
| | | | $T_{vj} = 125\text{ }^\circ\text{C}$ | 4500 | |
| Continuous DC forward current | I_F | | 1000 | A | |
| Repetitive peak forward current | I_{FRM} | $t_p = 1\text{ ms}$ | 2000 | A | |
| I^2t - value | I^2t | $t_p = 10\text{ ms}$, $V_R = 0\text{ V}$ | $T_{vj} = 125\text{ }^\circ\text{C}$ | 255 | kA^2s |
| Maximum power dissipation | P_{RQM} | | $T_{vj} = 125\text{ }^\circ\text{C}$ | 1600 | kW |
| Minimum turn-on time | t_{onmin} | | 10 | μs | |

Table 6 Characteristic values

| Parameter | Symbol | Note or test condition | Values | | | Unit |
|-------------------------------|----------|---|--------------------------------------|------|------|------|
| | | | Min. | Typ. | Max. | |
| Forward voltage | V_F | $I_F = 1000\text{ A}$, $V_{GE} = 0\text{ V}$ | $T_{vj} = 25\text{ }^\circ\text{C}$ | 2.80 | 3.40 | V |
| | | | $T_{vj} = 125\text{ }^\circ\text{C}$ | 2.70 | 3.20 | |
| Peak reverse recovery current | I_{RM} | $V_{CC} = 2800\text{ V}$, $I_F = 1000\text{ A}$, $V_{GE} = -15\text{ V}$, $-di_F/dt = 3500\text{ A}/\mu\text{s}$ ($T_{vj} = 125\text{ }^\circ\text{C}$) | $T_{vj} = 25\text{ }^\circ\text{C}$ | 1030 | | A |
| | | | $T_{vj} = 125\text{ }^\circ\text{C}$ | 1100 | | |

(table continues...)

Table 6 (continued) **Characteristic values**

| Parameter | Symbol | Note or test condition | Values | | | Unit | |
|--|------------|---|---------------------------------------|------|------|------------------|---------------|
| | | | Min. | Typ. | Max. | | |
| Recovered charge | Q_r | $V_{CC} = 2800 \text{ V}$, $I_F = 1000 \text{ A}$, $V_{GE} = -15 \text{ V}$, $-di_F/dt =$ $3500 \text{ A}/\mu\text{s}$ ($T_{vj} = 125 \text{ }^\circ\text{C}$) | $T_{vj} = 25 \text{ }^\circ\text{C}$ | | 860 | | μC |
| | | | $T_{vj} = 125 \text{ }^\circ\text{C}$ | | 1700 | | |
| Reverse recovery energy | E_{rec} | $V_{CC} = 2800 \text{ V}$, $I_F = 1000 \text{ A}$, $V_{GE} = -15 \text{ V}$, $-di_F/dt =$ $3500 \text{ A}/\mu\text{s}$ ($T_{vj} = 125 \text{ }^\circ\text{C}$) | $T_{vj} = 25 \text{ }^\circ\text{C}$ | | 1300 | | mJ |
| | | | $T_{vj} = 125 \text{ }^\circ\text{C}$ | | 2800 | | |
| Thermal resistance, junction to case | R_{thJC} | per diode | | | 25.5 | K/kW | |
| Thermal resistance, case to heat sink | R_{thCH} | per diode, $\lambda_{grease} = 1 \text{ W}/(\text{m}\cdot\text{K})$ | | 21.0 | | K/kW | |
| Temperature under switching conditions | T_{vjop} | | -50 | | 125 | $^\circ\text{C}$ | |

4 Characteristics diagrams

Output characteristic (typical), IGBT, Inverter

$$I_C = f(V_{CE})$$

$$V_{GE} = 15 \text{ V}$$

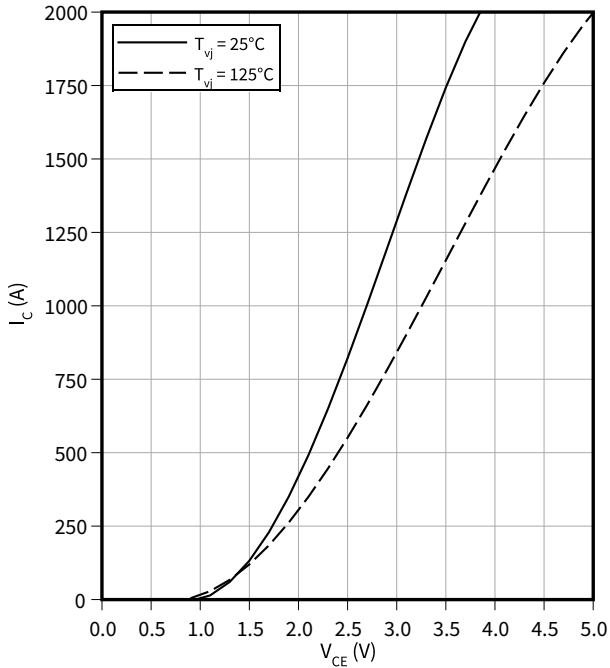

Output characteristic field (typical), IGBT, Inverter

$$I_C = f(V_{CE})$$

$$T_{vj} = 125 \text{ °C}$$

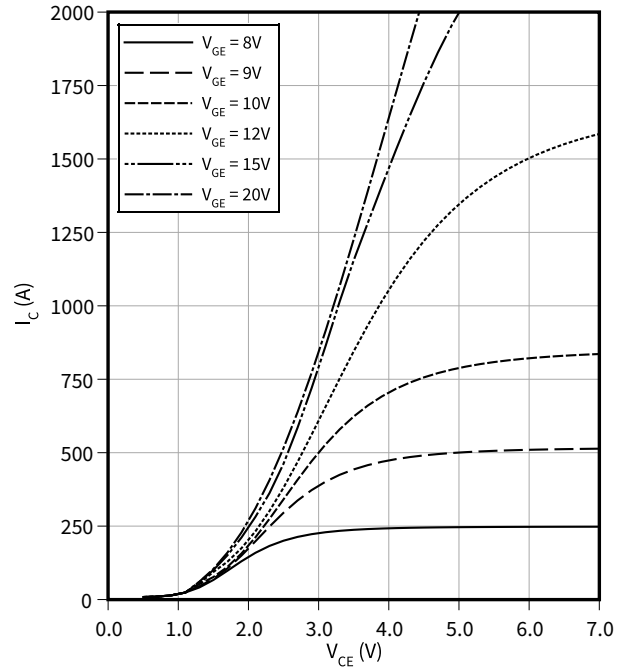

Transfer characteristic (typical), IGBT, Inverter

$$I_C = f(V_{GE})$$

$$V_{CE} = 20 \text{ V}$$

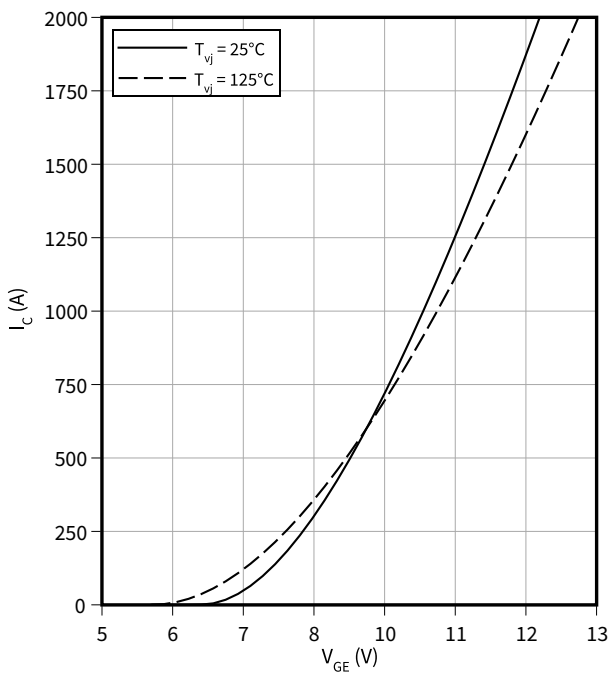

Switching losses (typical), IGBT, Inverter

$$E = f(I_C)$$

$$R_{Goff} = 9,1 \text{ } \Omega, R_{Gon} = 1 \text{ } \Omega, V_{CC} = 2800 \text{ V}, V_{GE} = \pm 15 \text{ V}$$

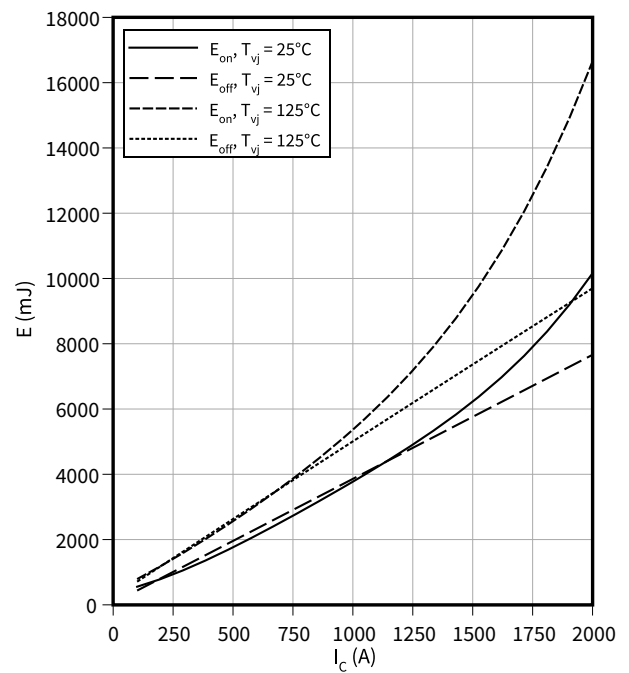

4 Characteristics diagrams

Switching losses (typical), IGBT, Inverter

$E = f(R_G)$

$I_C = 1000 \text{ A}$, $V_{CC} = 2800 \text{ V}$, $V_{GE} = \pm 15 \text{ V}$

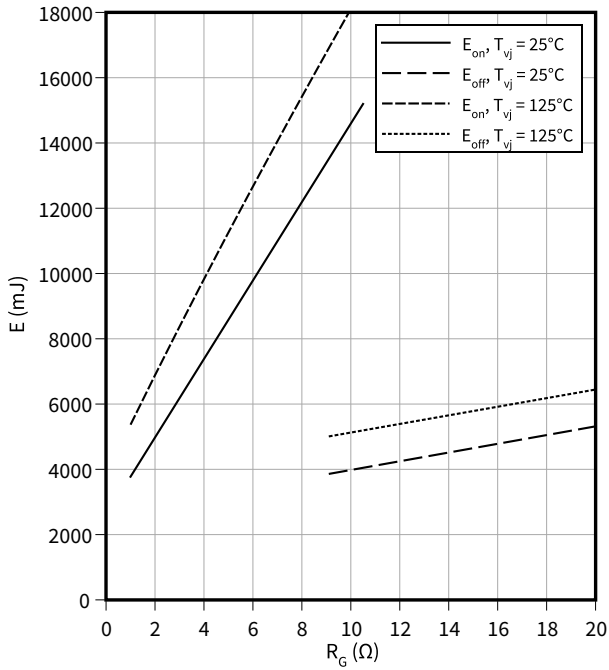

Switching times (typical), IGBT, Inverter

$t = f(I_C)$

$R_{Goff} = 9.1 \Omega$, $R_{Gon} = 1 \Omega$, $V_{GE} = \pm 15 \text{ V}$, $V_{CC} = 2800 \text{ V}$, $T_{vj} = 125 \text{ °C}$

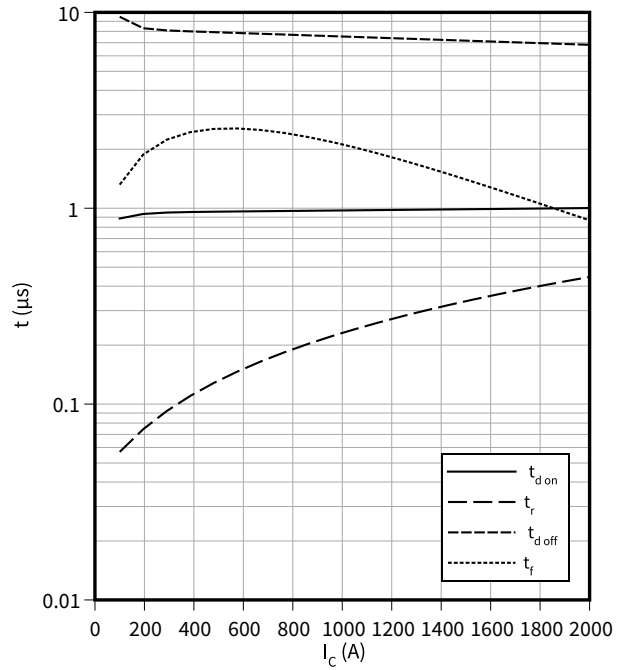

Switching times (typical), IGBT, Inverter

$t = f(R_G)$

$V_{GE} = \pm 15 \text{ V}$, $I_C = 1000 \text{ A}$, $V_{CC} = 2800 \text{ V}$, $T_{vj} = 125 \text{ °C}$

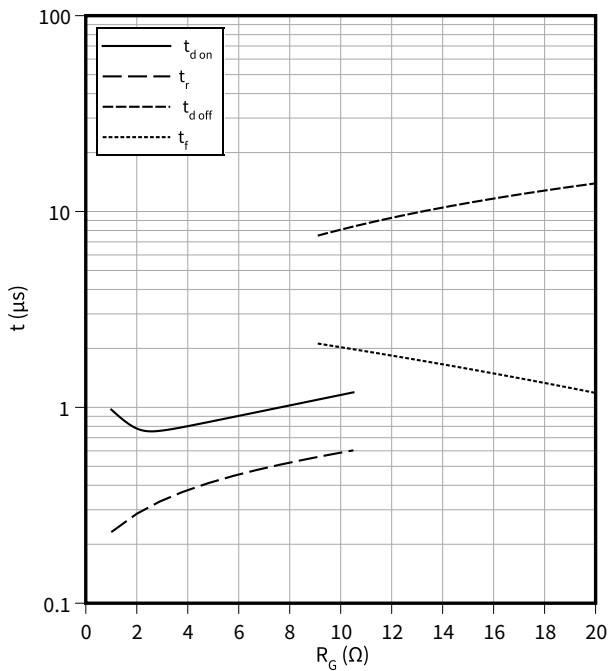

Transient thermal impedance , IGBT, Inverter

$Z_{th} = f(t)$

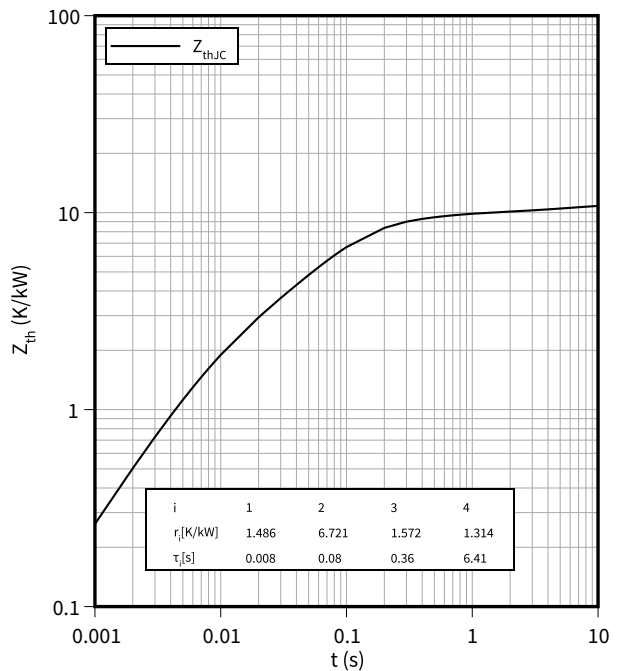

4 Characteristics diagrams

Reverse bias safe operating area (RBSOA), IGBT, Inverter

$I_C = f(V_{CE})$

$R_{Goff} = 9.1 \Omega, V_{GE} = \pm 15 V, T_{vj} = 125 \text{ }^\circ\text{C}$

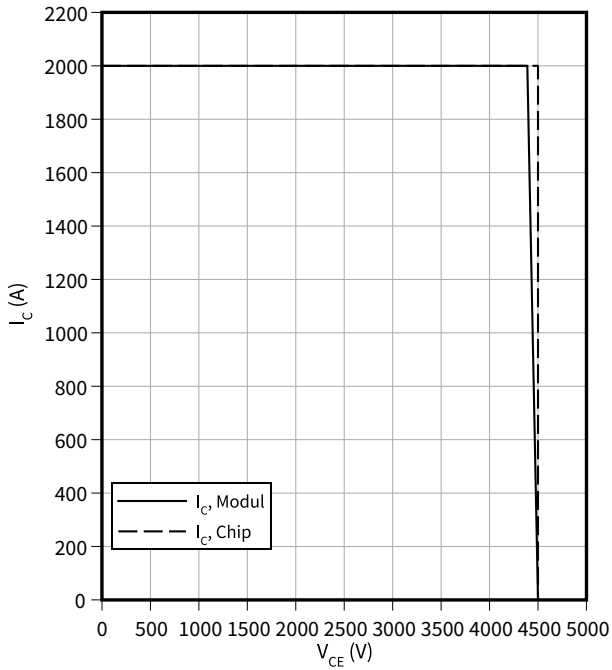

Capacity characteristic (typical), IGBT, Inverter

$C = f(V_{CE})$

$f = 1000 \text{ kHz}, V_{GE} = 0 V, T_{vj} = 25 \text{ }^\circ\text{C}$

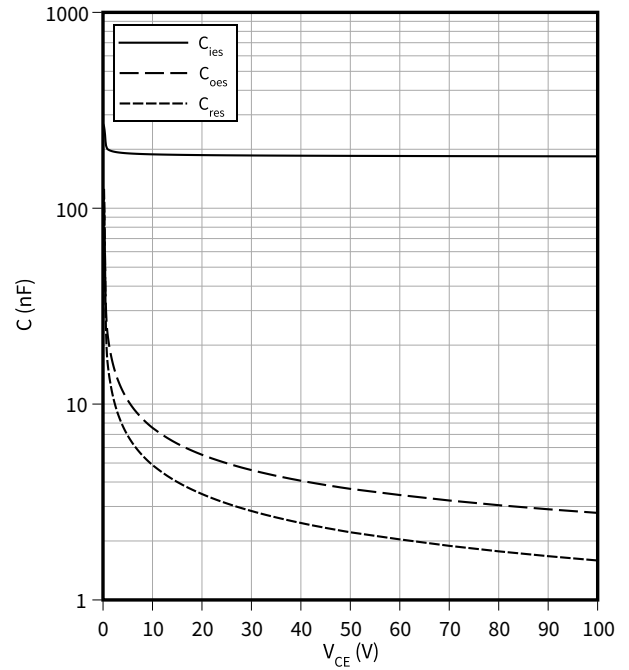

Gate charge characteristic (typical), IGBT, Inverter

$V_{GE} = f(Q_G)$

$I_C = 1000 \text{ A}, T_{vj} = 25 \text{ }^\circ\text{C}$

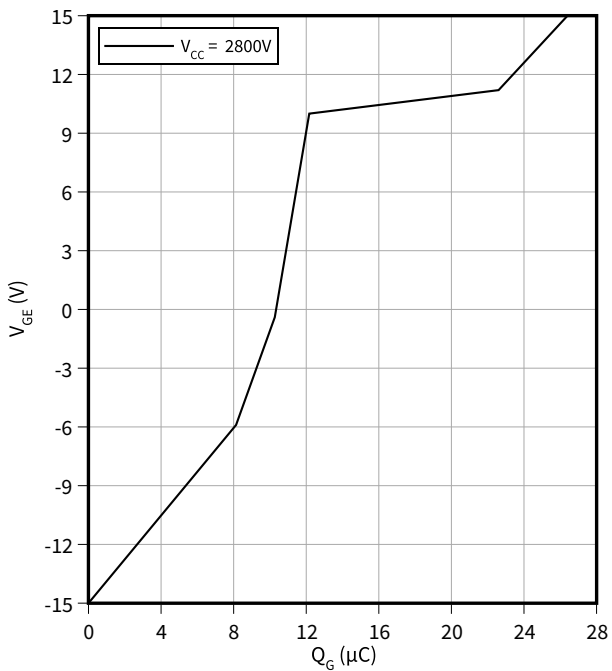

Forward characteristic (typical), Diode, Inverter

$I_F = f(V_F)$

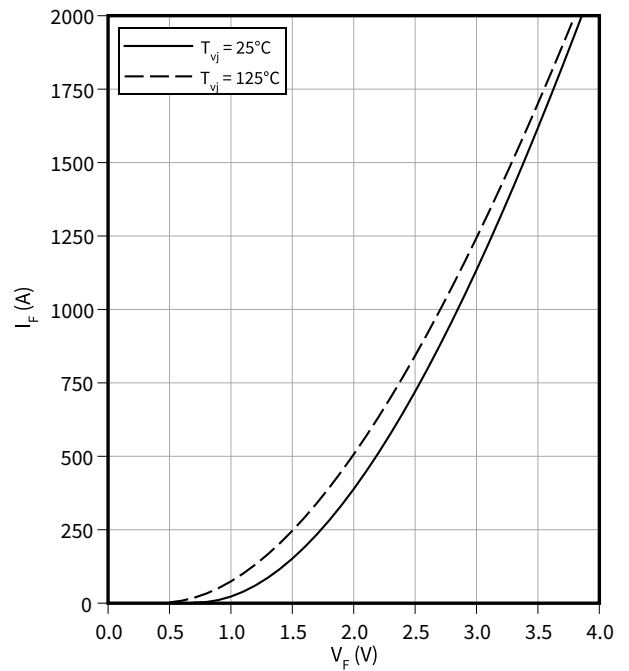

4 Characteristics diagrams

Switching losses (typical), Diode, Inverter

$E_{rec} = f(I_F)$

$R_{Gon} = R_{Gon}(IGBT), V_{CC} = 2800 V$

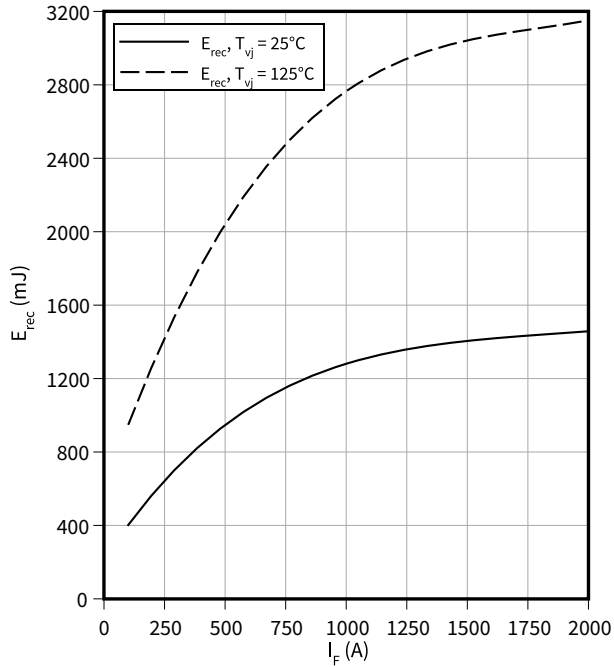

Switching losses (typical), Diode, Inverter

$E_{rec} = f(R_G)$

$I_F = 1000 A, V_{CC} = 2800 V$

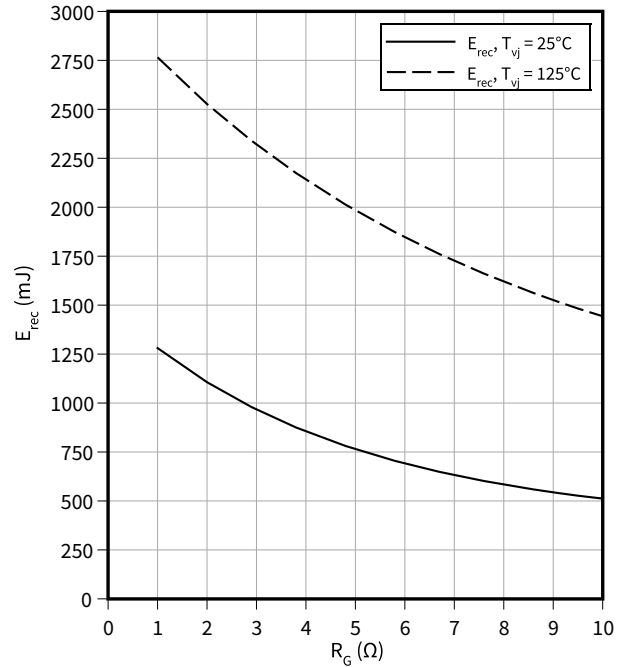

Transient thermal impedance, Diode, Inverter

$Z_{th} = f(t)$

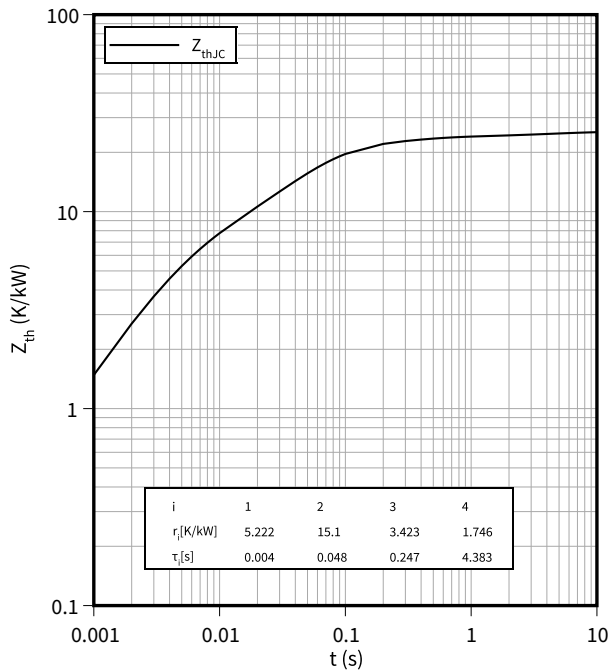

Safe operating area (SOA), Diode, Inverter

$I_R = f(V_R)$

$T_{vj} = 125 \text{ °C}$

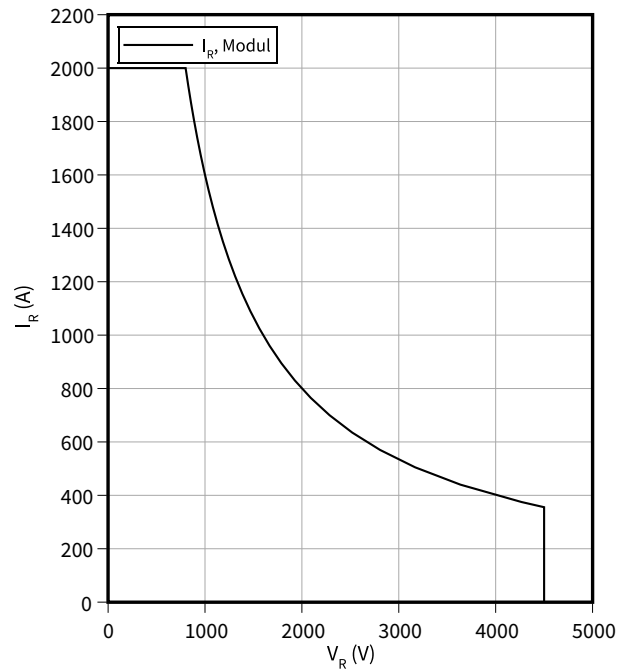

5 Circuit diagram

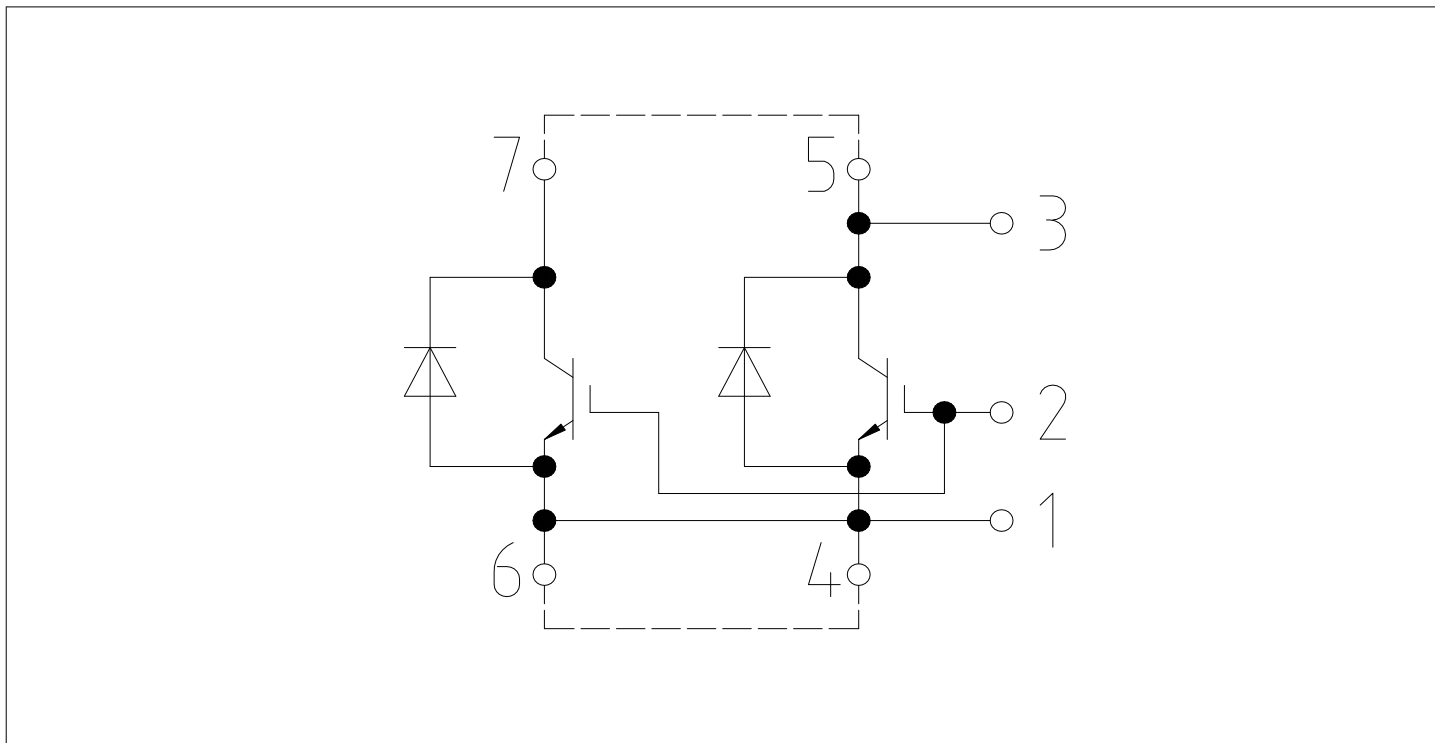

Figure 1

7 Module label code

| Module label code | | | |
|--------------------------|--|-----------------|-------------------------|
| Code format | Data Matrix | Barcode Code128 | |
| Encoding | ASCII text | Code Set A | |
| Symbol size | 16x16 | 23 digits | |
| Standard | IEC24720 and IEC16022 | IEC8859-1 | |
| Code content | <i>Content</i> | <i>Digit</i> | <i>Example</i> |
| | Module serial number | 1 - 5 | 71549 |
| | Module material number | 6 - 11 | 142846 |
| | Production order number | 12 - 19 | 55054991 |
| | Date code (production year) | 20 - 21 | 15 |
| | Date code (production week) | 22 - 23 | 30 |
| Example |   | | |
| | 71549142846550549911530 | | 71549142846550549911530 |

Figure 3

Revision history

| Document revision | Date of release | Description of changes |
|-------------------|-----------------|------------------------|
| 0.10 | 2021-09-15 | Initial version |
| 0.20 | 2022-02-24 | Target datasheet |
| 0.30 | 2022-05-16 | Preliminary datasheet |
| 1.00 | 2022-08-15 | Final datasheet |

Trademarks

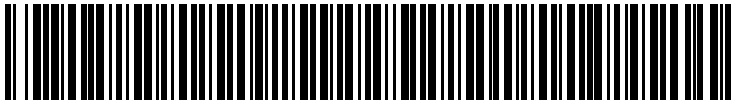
All referenced product or service names and trademarks are the property of their respective owners.

Edition 2022-08-15

Published by

Infineon Technologies AG

81726 Munich, Germany

© 2022 Infineon Technologies AG

All Rights Reserved.

Do you have a question about any aspect of this document?

Email: erratum@infineon.com

Document reference

IFX-ABA154-004

Important notice

The information given in this document shall in no event be regarded as a guarantee of conditions or characteristics ("Beschaffheitsgarantie").

With respect to any examples, hints or any typical values stated herein and/or any information regarding the application of the product, Infineon Technologies hereby disclaims any and all warranties and liabilities of any kind, including without limitation warranties of non-infringement of intellectual property rights of any third party.

In addition, any information given in this document is subject to customer's compliance with its obligations stated in this document and any applicable legal requirements, norms and standards concerning customer's products and any use of the product of Infineon Technologies in customer's applications.

The data contained in this document is exclusively intended for technically trained staff. It is the responsibility of customer's technical departments to evaluate the suitability of the product for the intended application and the completeness of the product information given in this document with respect to such application.

Please note that this product is not qualified according to the AEC Q100 or AEC Q101 documents of the Automotive Electronics Council.

Warnings

Due to technical requirements products may contain dangerous substances. For information on the types in question please contact your nearest Infineon Technologies office.

Except as otherwise explicitly approved by Infineon Technologies in a written document signed by authorized representatives of Infineon Technologies, Infineon Technologies' products may not be used in any applications where a failure of the product or any consequences of the use thereof can reasonably be expected to result in personal injury.