

LM2991QML Negative Low Dropout Adjustable Regulator

Check for Samples: [LM2991QML](#)

FEATURES

- Output Voltage Adjustable From -2V to -25V
- Output Current in Excess of 1A
- Dropout Voltage Typically 0.6V at 1A Load
- Low Quiescent Current
- Internal Short Circuit Current Limit
- Internal Thermal Shutdown with Hysteresis
- TTL, CMOS Compatible $\overline{\text{ON}}/\text{OFF}$ Switch
- Functional Complement to the LM2941 Series

APPLICATIONS

- Post Switcher Regulator
- Local, On-card, Regulation
- Battery Operated Equipment

DESCRIPTION

The LM2991 is a low dropout adjustable negative regulator with a output voltage range between -2V to -25V . The LM2991 provides up to 1A of load current and features a $\overline{\text{ON}}$ /Off pin for remote shutdown capability.

The LM2991 uses new circuit design techniques to provide a low dropout voltage, low quiescent current and low temperature coefficient precision reference. The dropout voltage at 1A load current is typically 0.6V and a ensured worst-case maximum of 1V over the entire operating temperature range. The quiescent current is typically 1 mA with a 1A load current and an input-output voltage differential greater than 3V. A unique circuit design of the internal bias supply limits the quiescent current to only 9 mA (typical) when the regulator is in the dropout mode ($V_O - V_I \leq 3\text{V}$).

The LM2991 is short-circuit proof, and thermal shutdown includes hysteresis to enhance the reliability of the device when inadvertently overloaded for extended periods.

CONNECTION DIAGRAMS

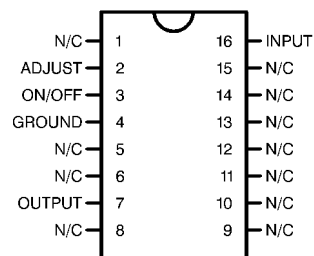

Package Number NAC0016A (Top View)
16-Lead CLGA Package



Please be aware that an important notice concerning availability, standard warranty, and use in critical applications of Texas Instruments semiconductor products and disclaimers thereto appears at the end of this data sheet.

All trademarks are the property of their respective owners.



These devices have limited built-in ESD protection. The leads should be shorted together or the device placed in conductive foam during storage or handling to prevent electrostatic damage to the MOS gates.

EQUIVALENT SCHEMATIC

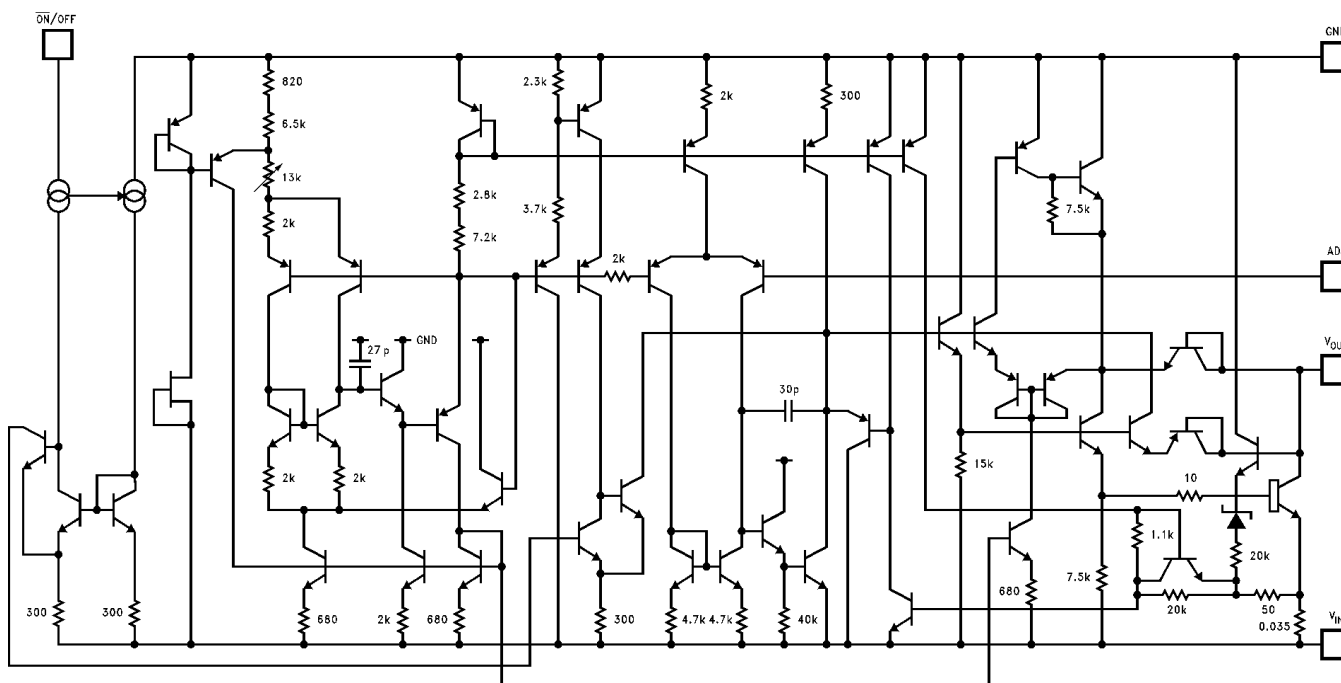

ABSOLUTE MAXIMUM RATINGS ⁽¹⁾

Input Voltage		-26V to +0.3V
Power Dissipation ⁽²⁾		Internally limited
Junction Temperature (T_{Jmax})		150°C
Storage Temperature Range		$-65^{\circ}\text{C} \leq T_A \leq +150^{\circ}\text{C}$
Thermal Resistance ⁽³⁾	θ_{JA} CLGA (Still Air at 0.5°C/W) "GW"	130°C/W
	θ_{JA} CLGA (500LF/Min Air flow at 0.5°C/W) "GW"	80°C/W
	θ_{JC} CLGA "GW"	6°C/W
Package Weight "GW"		410mg
Lead Temperature (Soldering, 10 sec.)		260°C
ESD Susceptibility ⁽⁴⁾		1,500V

- (1) Absolute Maximum Ratings indicate limits beyond which damage to the device may occur. Operating Ratings indicate conditions for which the device is functional, but do not ensure specific performance limits. For ensured specifications and test conditions, see the Electrical Characteristics. The ensured specifications apply only for the test conditions listed. Some performance characteristics may degrade when the device is not operated under the listed test conditions.
- (2) The maximum power dissipation must be derated at elevated temperatures and is dictated by T_{Jmax} (maximum junction temperature), θ_{JA} (package junction to ambient thermal resistance), and T_A (ambient temperature). The maximum allowable power dissipation at any temperature is $P_{Dmax} = (T_{Jmax} - T_A)/\theta_{JA}$ or the number given in the Absolute Maximum Ratings, whichever is lower.
- (3) The package material for these devices allows much improved heat transfer over our standard ceramic packages. In order to take full advantage of this improved heat transfer, heat sinking must be provided between the package base (directly beneath the die), and either metal traces on, or thermal vias through, the printed circuit board. Without this additional heat sinking, device power dissipation must be calculated using θ_{JA} , rather than θ_{JC} , thermal resistance. It must not be assumed that the device leads will provide substantial heat transfer out the package, since the thermal resistance of the leadframe material is very poor, relative to the material of the package base. The stated θ_{JC} thermal resistance is for the package material only, and does not account for the additional thermal resistance between the package base and the printed circuit board. The user must determine the value of the additional thermal resistance and must combine this with the stated value for the package, to calculate the total allowed power dissipation for the device. The user must determine the value of the additional thermal resistance and must combine this with the stated value for the package, to calculate the total allowed power dissipation for the device.
- (4) Human body model, 1.5 k Ω in series with 100 pF.

RECOMMENDED OPERATING CONDITIONS ⁽¹⁾

Operating Temperature Range (T_A)	$-55^{\circ}\text{C} \leq T_A \leq +125^{\circ}\text{C}$
Maximum Input Voltage (Operational)	-26V

- (1) Absolute Maximum Ratings indicate limits beyond which damage to the device may occur. Operating Ratings indicate conditions for which the device is functional, but do not ensure specific performance limits. For ensured specifications and test conditions, see the Electrical Characteristics. The ensured specifications apply only for the test conditions listed. Some performance characteristics may degrade when the device is not operated under the listed test conditions.

QUALITY CONFORMANCE INSPECTION

Mil-Std-883, Method 5005 - Group A		
Subgroup	Description	Temp °C
1	Static tests at	+25
2	Static tests at	+125
3	Static tests at	-55
4	Dynamic tests at	+25
5	Dynamic tests at	+125
6	Dynamic tests at	-55
7	Functional tests at	+25
8A	Functional tests at	+125
8B	Functional tests at	-55
9	Switching tests at	+25
10	Switching tests at	+125
11	Switching tests at	-55
12	Settling time at	+25
13	Settling time at	+125
14	Settling time at	-55

LM2991 ELECTRICAL CHARACTERISTICS DC PARAMETERS

The following conditions apply, unless otherwise specified.

DC: $V_I = -10V$, $V_O = -3V$, $I_O = 1A$, $C_O = 47\mu F$, $R_L = 2.7k\Omega$

Symbol	Parameter	Conditions	Notes	Min	Max	Units	Sub-groups
V_{Ref}	Reference Voltage	$5mA \leq I_O \leq 1A$		-1.234	-1.186	V	1
		$5mA \leq I_O \leq 1A$, $V_O - 1V \geq V_I \geq -26V$		-1.27	-1.15	V	2, 3
V_O	Output Voltage Range				-3.0	V	1
		$V_I = -26V$		-24		V	1
				-25		V	2, 3
V_{RLine}	Line Regulation	$I_O = 5mA$, $V_O - 1V \geq V_I \geq -26V$		-26	+26	mV	1, 2, 3
V_{RLoad}	Load Regulation	$50mA \leq I_O \leq 1A$		-12	+12	mV	1
				-15	+15	mV	2, 3
V_{DO}	Dropout Voltage	$I_O = 0.1A$, $\Delta V_O \leq 100mV$			0.2	V	1
					0.3	V	2, 3
		$I_O = 1A$, $\Delta V_O \leq 100mV$			0.8	V	1
					1.0	V	2, 3
I_Q	Quiescent Current	$I_O \leq 1A$			5.0	mA	1, 2, 3
	Dropout Quiescent Current	$V_I = V_O$, $I_O \leq 1A$			50	mA	1, 2, 3
V_{ON}	Output Noise	10Hz - 100KHz, $I_O = 5mA$			450	μV	1
					500	μV	2, 3
	$\overline{ON/OFF}$ Input Voltage	$V_O : ON$			0.6	V	1, 2, 3
		$V_O : OFF$		2.4		V	1, 2, 3
	$\overline{ON/OFF}$ Input Current	$\overline{VON/OFF} = 0.6V$ ($V_O : ON$)			10	μA	1
					25	μA	2, 3
		$\overline{VON/OFF} = 2.4V$ ($V_O : OFF$)			100	μA	1
					150	μA	2, 3
I_L	Output Leakage Current	$V_I = -26V$, $\overline{VON/OFF} = 2.4V$, $V_O = 0V$			250	μA	1
					300	μA	2, 3
I_{Limit}	Current Limit	$V_O = 0V$		1.5	2.5	A	1
				1.0	4.0	A	2, 3

LM2991 ELECTRICAL CHARACTERISTICS AC PARAMETERS

The following conditions apply, unless otherwise specified.

AC: $V_I = -10V$, $V_O = -3V$, $I_O = 1A$, $C_O = 47\mu F$, $R_L = 2.7k\Omega$

Symbol	Parameter	Conditions	Notes	Min	Max	Units	Sub-groups
RR	Ripple Rejection	$V_{Ripple} = 1V_{RMS}$, $F_{Ripple} = 1KHz$, $I_O = 5mA$		50		dB	1

LM2991 ELECTRICAL CHARACTERISTICS DC DRIFT PARAMETERS

The following conditions apply, unless otherwise specified. DC: $V_I = -10V$, $V_O = -3V$, $I_O = 1A$, $C_O = 47\mu F$, $R_L = 2.7k\Omega$

Deltas not required on B-Level product. Deltas required for S-Level product ONLY.

Symbol	Parameter	Conditions	Notes	Min	Max	Units	Sub-groups
V_{Ref}	Reference Voltage	$5mA \leq I_O \leq 1A$			± 20	mV	1

TYPICAL PERFORMANCE CHARACTERISTICS

Dropout Voltage

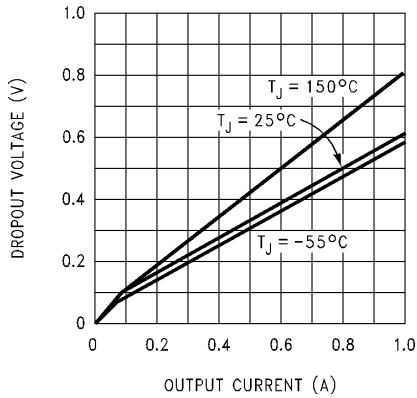

Figure 1.

Normalized Output Voltage

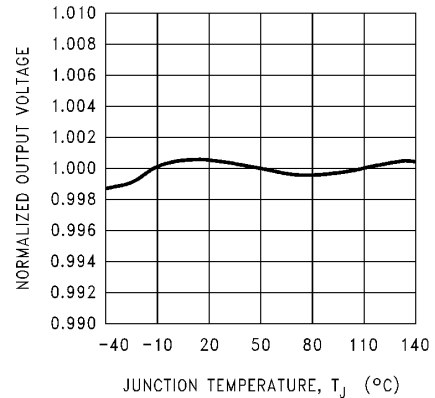

Figure 2.

Output Voltage

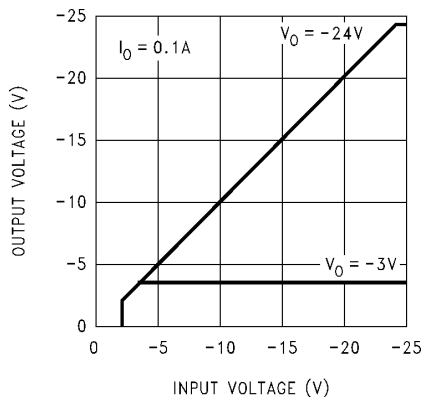

Figure 3.

Output Noise Voltage

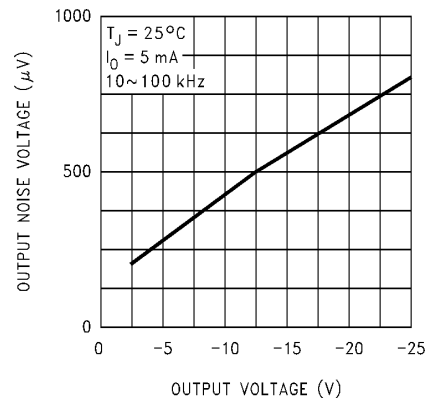

Figure 4.

Quiescent Current

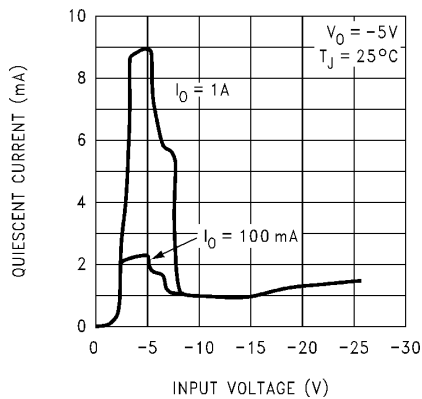

Figure 5.

Maximum Output Current

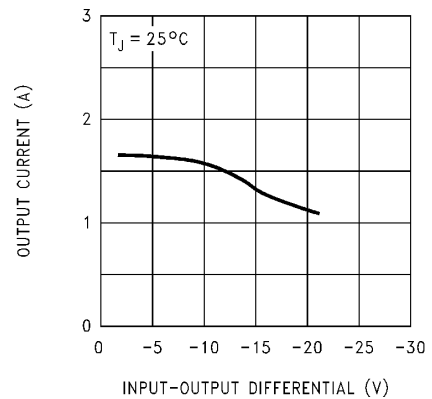

Figure 6.

TYPICAL PERFORMANCE CHARACTERISTICS (continued)

Line Transient Response

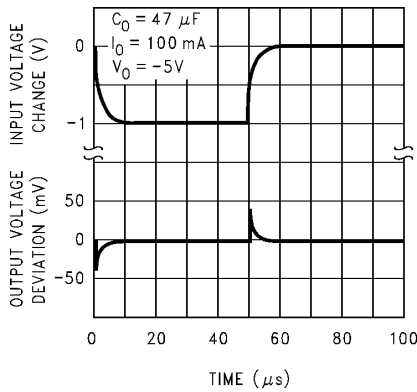

Figure 7.

Load Transient Response

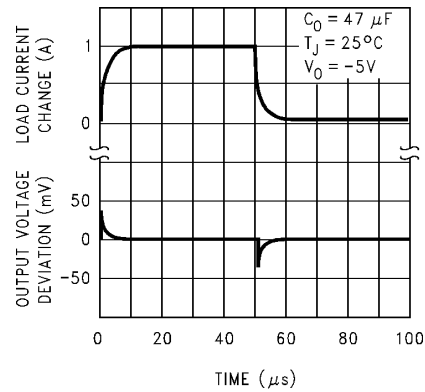

Figure 8.

Maximum Output Current

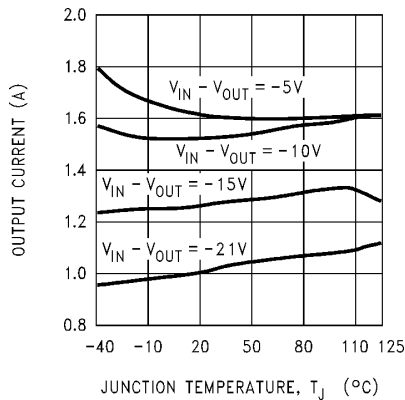

Figure 9.

Ripple Rejection

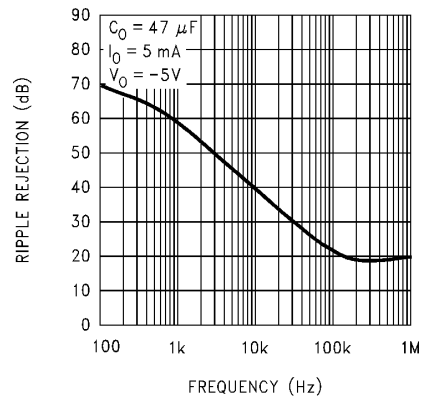

Figure 10.

Output Impedance

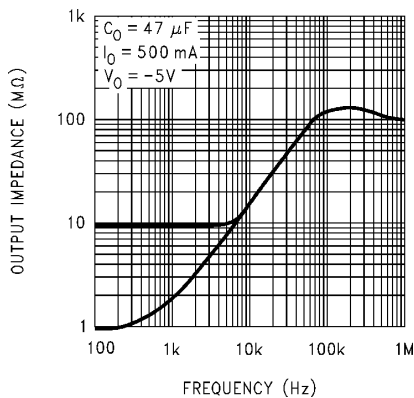

Figure 11.

$\overline{\text{ON}}$ /OFF Control Voltage

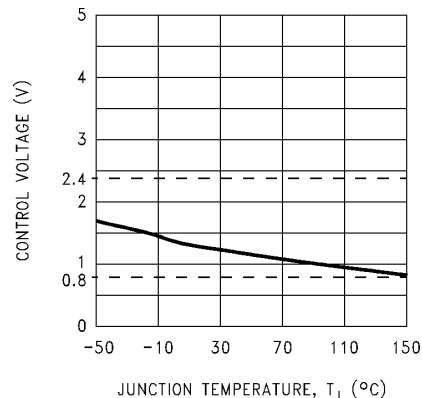

Figure 12.

TYPICAL PERFORMANCE CHARACTERISTICS (continued)

Adjust Pin Current

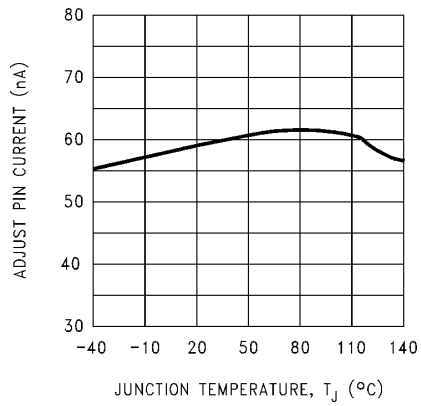

Figure 13.

Low Voltage Behavior

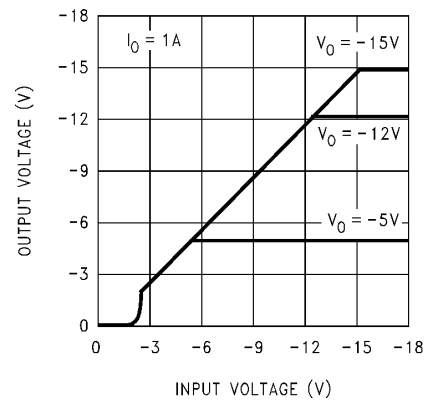

Figure 14.

APPLICATION HINTS

EXTERNAL CAPACITORS

Like any low-dropout regulator, external capacitors are required to stabilize the control loop. These capacitors must be correctly selected for proper performance.

INPUT CAPACITOR

An input capacitor is required if the regulator is located more than 6" from the input power supply filter capacitor (or if no other input capacitor is present).

A solid Tantalum or ceramic capacitor whose value is at least 1 μF is recommended, but an aluminum electrolytic ($\geq 10 \mu\text{F}$) may be used. However, aluminum electrolytics should not be used in applications where the ambient temperature can drop below 0°C because their internal impedance increases significantly at cold temperatures.

OUTPUT CAPACITOR

The output capacitor must meet the ESR limits shown in the graph, which means it must have an ESR between about 25 m Ω and 10 Ω .

A solid Tantalum (value $\geq 1 \mu\text{F}$) is the best choice for the output capacitor. An aluminum electrolytic ($\geq 10 \mu\text{F}$) may be used if the ESR is in the stable range.

It should be noted that the ESR of a typical aluminum electrolytic will increase by as much as 50X as the temperature is reduced from 25°C down to -40°C , while a Tantalum will exhibit an ESR increase of about 2X over the same range. For this and other reasons, aluminum electrolytics should not be used in applications where low operating temperatures occur.

The lower stable ESR limit of 25 m Ω means that ceramic capacitors can not be used directly on the output of an LDO. A ceramic ($\geq 2.2 \mu\text{F}$) can be used on the output if some external resistance is placed in series with it (1 Ω recommended). Dielectric types X7R or X5R must be used if the temperature range of the application varies more than $\pm 25^\circ\text{C}$ from ambient to assure the amount of capacitance is sufficient.

CERAMIC BYPASS CAPACITORS

Many designers place distributed ceramic capacitors whose value is in the range of 1000 pF to 0.1 μF at the power input pins of the IC's across a circuit board. These can cause reduced phase margin or oscillations in LDO regulators.

The advent of multi-layer boards with dedicated power and ground planes has removed the trace inductance that (previously) provided the necessary "decoupling" to shield the output of the LDO from the effects of bypass capacitors.

These capacitors should be avoided if possible, and kept as far away from the LDO output as is practical.

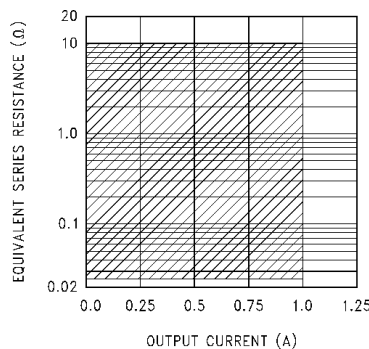

Figure 15. Output Capacitor ESR Range

MINIMUM LOAD

A minimum load current of 500 μ A is required for proper operation. The external resistor divider can provide the minimum load, with the resistor from the adjust pin to ground set to 2.4 k Ω .

SETTING THE OUTPUT VOLTAGE

The output voltage of the LM2991 is set externally by a resistor divider using the following equation:

$$V_{OUT} = V_{REF} \times (1 + R_2/R_1) - (I_{ADJ} \times R_2)$$

where $V_{REF} = -1.21$ V. The output voltage can be programmed within the range of -3 V to -24 V, typically an even greater range of -2 V to -25 V. The adjust pin current is about 60 nA, causing a slight error in the output voltage. However, using resistors lower than 100 k Ω makes the adjust pin current negligible. For example, neglecting the adjust pin current, and setting R_2 to 100 k Ω and V_{OUT} to -5 V, results in an output voltage error of only 0.16%.

ON/OFF PIN

The LM2991 regulator can be turned off by applying a TTL or CMOS level high signal to the $\overline{ON/OFF}$ pin (see Adjustable Current Sink Application).

FORCING THE OUTPUT POSITIVE

Due to an internal clamp circuit, the LM2991 can withstand positive voltages on its output. If the voltage source pulling the output positive is DC, the current must be limited to 1.5A. A current over 1.5A fed back into the LM2991 could damage the device. The LM2991 output can also withstand fast positive voltage transients up to 26V, without any current limiting of the source. However, if the transients have a duration of over 1 mS, the output should be clamped with a Schottky diode to ground.

Typical Applications

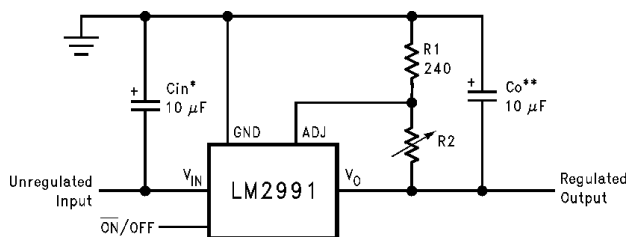

$$V_O = V_{Ref} (1 + R_2/R_1)$$

*Required if the regulator is located further than 6 inches from the power supply filter capacitors. A 1 μ F solid tantalum or a 10 μ F aluminum electrolytic capacitor is recommended.

**Required for stability. Must be at least a 10 μ F aluminum electrolytic or a 1 μ F solid tantalum to maintain stability. May be increased without bound to maintain regulation during transients. Locate the capacitor as close as possible to the regulator. The equivalent series resistance (ESR) is critical, and should be less than 10 Ω over the same operating temperature range as the regulator.

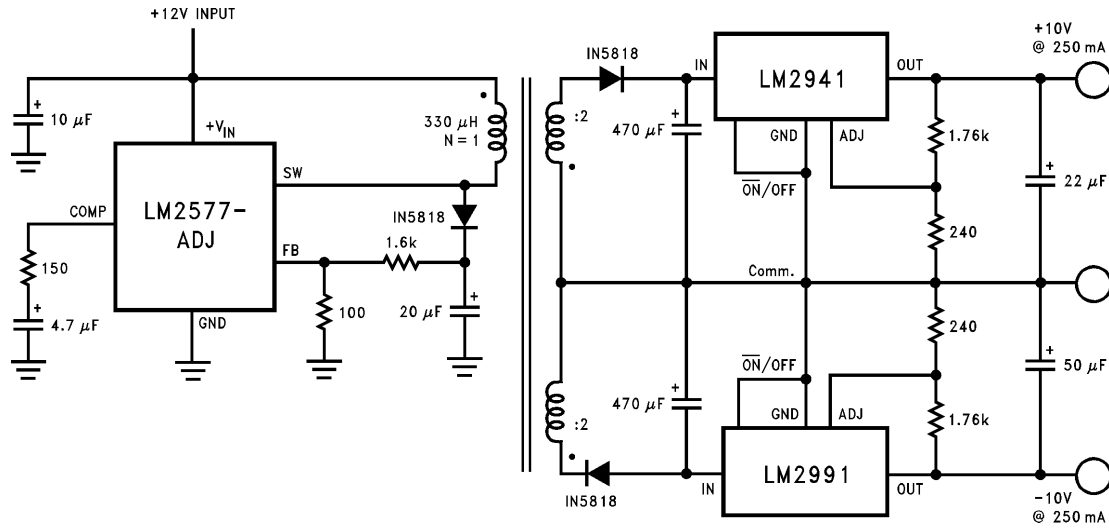

Figure 16. Fully Isolated Post-Switcher Regulator

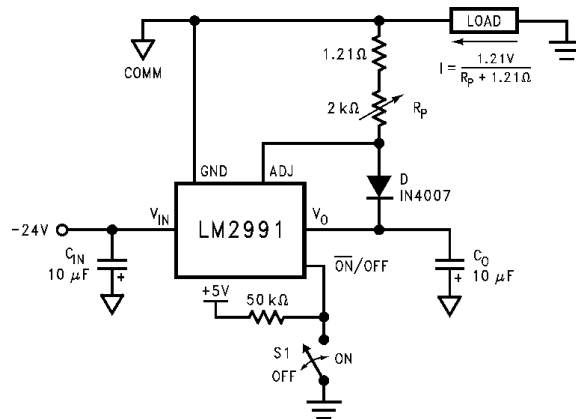

Figure 17. Adjustable Current Sink

REVISION HISTORY

Released	Revision	Section	Changes
03/10/06	A	New Release, Corporate format	1 MDS data sheet converted into one Corp. data sheet format. MNLM2991-X Rev 1A1 will be archived.
05-Oct-2011	B	Ordering Information, Absolute Maximum Ratings	Added new 'GW' NSID and —02 SMD part number. Added Theta JA & Theta JC as well as the weight for the 'GW' device. LM2991QML Rev A will be archived.

PACKAGING INFORMATION

Orderable Device	Status (1)	Package Type	Package Drawing	Pins	Package Qty	Eco Plan (2)	Lead finish/ Ball material (6)	MSL Peak Temp (3)	Op Temp (°C)	Device Marking (4/5)	Samples
5962-9650502QXA	ACTIVE	CFP	NAC	16	88	Non-RoHS & Green	Call TI	Level-1-NA-UNLIM	-55 to 125	LM2991GW-QML Q 5962-96505 02QXA ACO 02QXA >T	Samples
LM2991 MD8	ACTIVE	DIESALE	Y	0	140	RoHS & Green	Call TI	Level-1-NA-UNLIM	-55 to 125		Samples
LM2991 MWC	ACTIVE	WAFERSALE	YS	0	1	RoHS & Green	Call TI	Level-1-NA-UNLIM	-40 to 85		Samples
LM2991GW-QML	ACTIVE	CFP	NAC	16	88	Non-RoHS & Green	Call TI	Level-1-NA-UNLIM	-55 to 125	LM2991GW-QML Q 5962-96505 02QXA ACO 02QXA >T	Samples

(1) The marketing status values are defined as follows:

ACTIVE: Product device recommended for new designs.

LIFEBUY: TI has announced that the device will be discontinued, and a lifetime-buy period is in effect.

NRND: Not recommended for new designs. Device is in production to support existing customers, but TI does not recommend using this part in a new design.

PREVIEW: Device has been announced but is not in production. Samples may or may not be available.

OBSOLETE: TI has discontinued the production of the device.

(2) **RoHS:** TI defines "RoHS" to mean semiconductor products that are compliant with the current EU RoHS requirements for all 10 RoHS substances, including the requirement that RoHS substance do not exceed 0.1% by weight in homogeneous materials. Where designed to be soldered at high temperatures, "RoHS" products are suitable for use in specified lead-free processes. TI may reference these types of products as "Pb-Free".

RoHS Exempt: TI defines "RoHS Exempt" to mean products that contain lead but are compliant with EU RoHS pursuant to a specific EU RoHS exemption.

Green: TI defines "Green" to mean the content of Chlorine (Cl) and Bromine (Br) based flame retardants meet JS709B low halogen requirements of <=1000ppm threshold. Antimony trioxide based flame retardants must also meet the <=1000ppm threshold requirement.

(3) MSL, Peak Temp. - The Moisture Sensitivity Level rating according to the JEDEC industry standard classifications, and peak solder temperature.

(4) There may be additional marking, which relates to the logo, the lot trace code information, or the environmental category on the device.

(5) Multiple Device Markings will be inside parentheses. Only one Device Marking contained in parentheses and separated by a "~" will appear on a device. If a line is indented then it is a continuation of the previous line and the two combined represent the entire Device Marking for that device.

⁽⁶⁾ Lead finish/Ball material - Orderable Devices may have multiple material finish options. Finish options are separated by a vertical ruled line. Lead finish/Ball material values may wrap to two lines if the finish value exceeds the maximum column width.

Important Information and Disclaimer:The information provided on this page represents TI's knowledge and belief as of the date that it is provided. TI bases its knowledge and belief on information provided by third parties, and makes no representation or warranty as to the accuracy of such information. Efforts are underway to better integrate information from third parties. TI has taken and continues to take reasonable steps to provide representative and accurate information but may not have conducted destructive testing or chemical analysis on incoming materials and chemicals. TI and TI suppliers consider certain information to be proprietary, and thus CAS numbers and other limited information may not be available for release.

In no event shall TI's liability arising out of such information exceed the total purchase price of the TI part(s) at issue in this document sold by TI to Customer on an annual basis.

EXAMPLE BOARD LAYOUT

NAC0016A

CFP - 2.33mm max height

CERAMIC FLATPACK

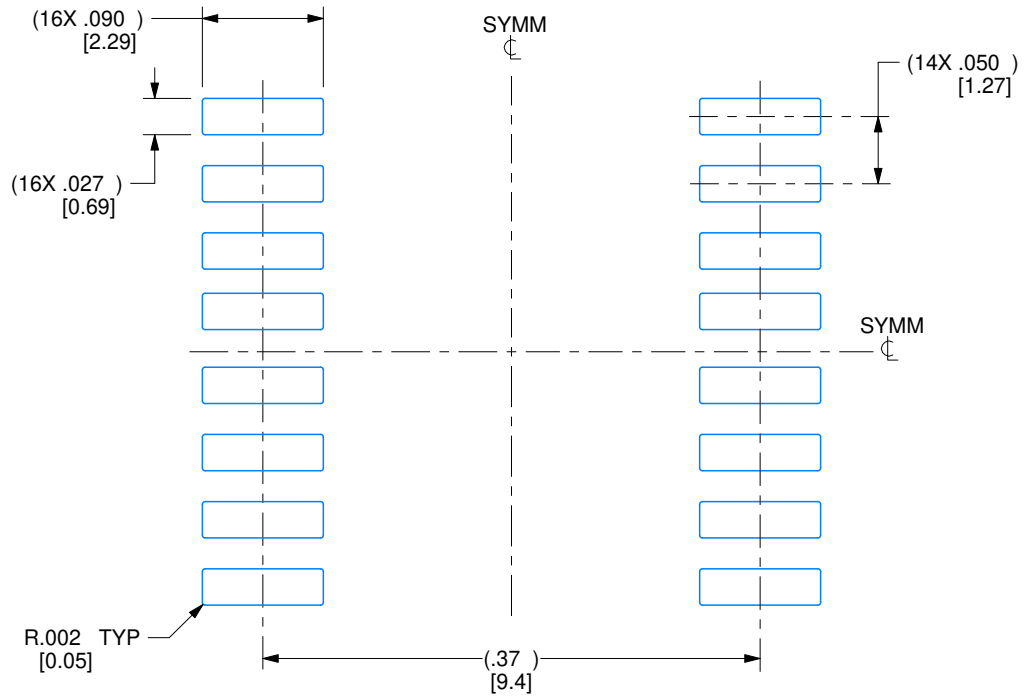

RECOMMENDED LAND PATTERN

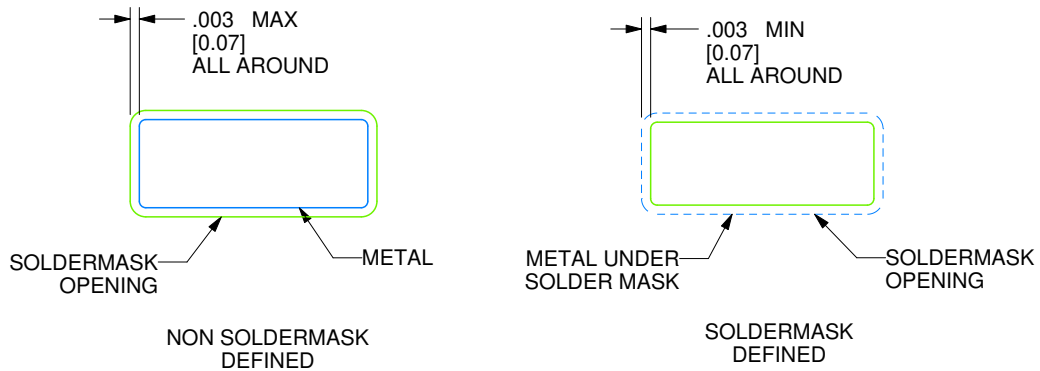

4215198/C 08/2022

REVISIONS

REV	DESCRIPTION	E.C.N.	DATE	BY/APP'D
A	RELEASE TO DOCUMENT CONTROL	2197879	12/30/2021	TINA TRAN / ANIS FAUZI
B	NO CHANGE TO DRAWING; REVISION FOR YODA RELEASE;	2198832	02/15/2022	K. SINCERBOX
C	.387±.003 WAS .39000±.00012;	2200917	08/08/2022	D. CHIN / K. SINCERBOX

IMPORTANT NOTICE AND DISCLAIMER

TI PROVIDES TECHNICAL AND RELIABILITY DATA (INCLUDING DATA SHEETS), DESIGN RESOURCES (INCLUDING REFERENCE DESIGNS), APPLICATION OR OTHER DESIGN ADVICE, WEB TOOLS, SAFETY INFORMATION, AND OTHER RESOURCES "AS IS" AND WITH ALL FAULTS, AND DISCLAIMS ALL WARRANTIES, EXPRESS AND IMPLIED, INCLUDING WITHOUT LIMITATION ANY IMPLIED WARRANTIES OF MERCHANTABILITY, FITNESS FOR A PARTICULAR PURPOSE OR NON-INFRINGEMENT OF THIRD PARTY INTELLECTUAL PROPERTY RIGHTS.

These resources are intended for skilled developers designing with TI products. You are solely responsible for (1) selecting the appropriate TI products for your application, (2) designing, validating and testing your application, and (3) ensuring your application meets applicable standards, and any other safety, security, regulatory or other requirements.

These resources are subject to change without notice. TI grants you permission to use these resources only for development of an application that uses the TI products described in the resource. Other reproduction and display of these resources is prohibited. No license is granted to any other TI intellectual property right or to any third party intellectual property right. TI disclaims responsibility for, and you will fully indemnify TI and its representatives against, any claims, damages, costs, losses, and liabilities arising out of your use of these resources.

TI's products are provided subject to [TI's Terms of Sale](#) or other applicable terms available either on [ti.com](https://www.ti.com) or provided in conjunction with such TI products. TI's provision of these resources does not expand or otherwise alter TI's applicable warranties or warranty disclaimers for TI products.

TI objects to and rejects any additional or different terms you may have proposed.

Mailing Address: Texas Instruments, Post Office Box 655303, Dallas, Texas 75265
Copyright © 2023, Texas Instruments Incorporated