

SPECIFICATIONS

"Preliminary data"



Model Number: CR1212UB-Y51
Part Number: 17000208A

Version:
Apr 11, 2017

Mechanical Drawing:

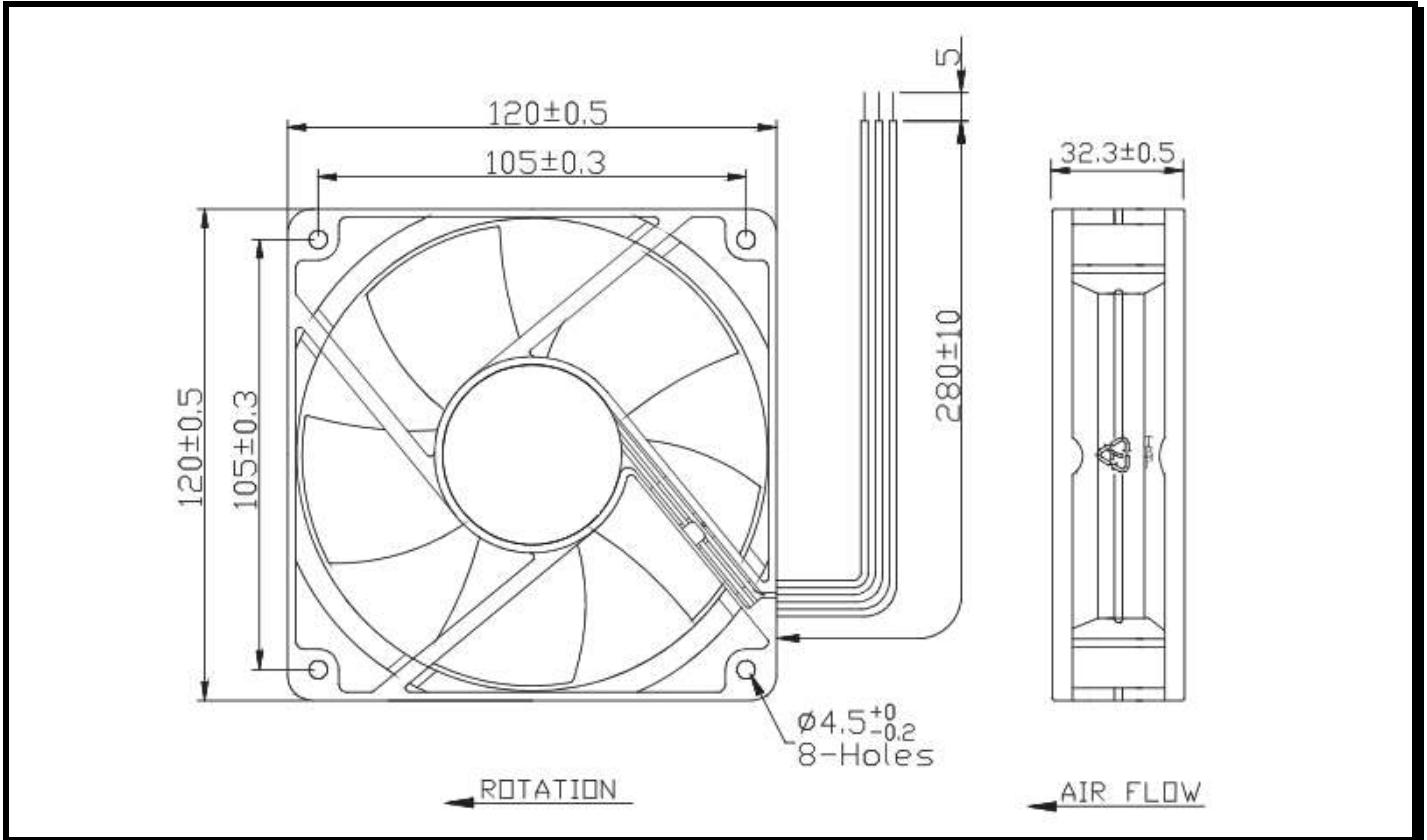

Motor:

Nominal Voltage	= 12 VDC
Nominal Running Current	= 0.51 Amps
Power Input	= 6.12 Watts
Speed	= 3200 RPM
Bearings	= Ball
Air Flow	= 133.44 CFM
Static Pressure:	= 0.32 Inch of H ₂ O
Acoustic	= 48.4 dB(A)
Weight	= 213.0 g

Construction:

Housing: UL94V-0 Glass Filled Polyester (P.B.T)
Impeller: UL94V-0 Glass Filled Polyester (P.B.T)

Life Expectancy:

This fan is designed for continuous duty life of 70,000 hours at 40°C.

Additional Features:

Brushless DC Motor
Locked Rotor Protection
Polarity Protected
Automatic Restart Capability
Operating Temperature: -10° C to 70° C
Storage Temperature: -40° C to 70° C

Termination:

280 ± 10 mm Lead wires, AWG 24, UL 1007

Agency Approvals:

UL, CUL, TUV, CE