

2-1971793-1 ✓ ACTIVE



## GRACE INERTIA 2.5

TE Internal #: 2-1971793-1

Housing, Plug, Wire-to-Wire, 2 Position, .098 in [2.5 mm] Centerline, Crimp, 1 Row, Natural, Mating Retention, Wire & Cable, GRACE INERTIA 2.5

[View on TE.com >](#)

Connectors > PCB Connectors > Wire-to-Board Connectors > Wire-to-Board Connector Assemblies & Housings >

Glow Wire Sig GRACE INERTIA Plug

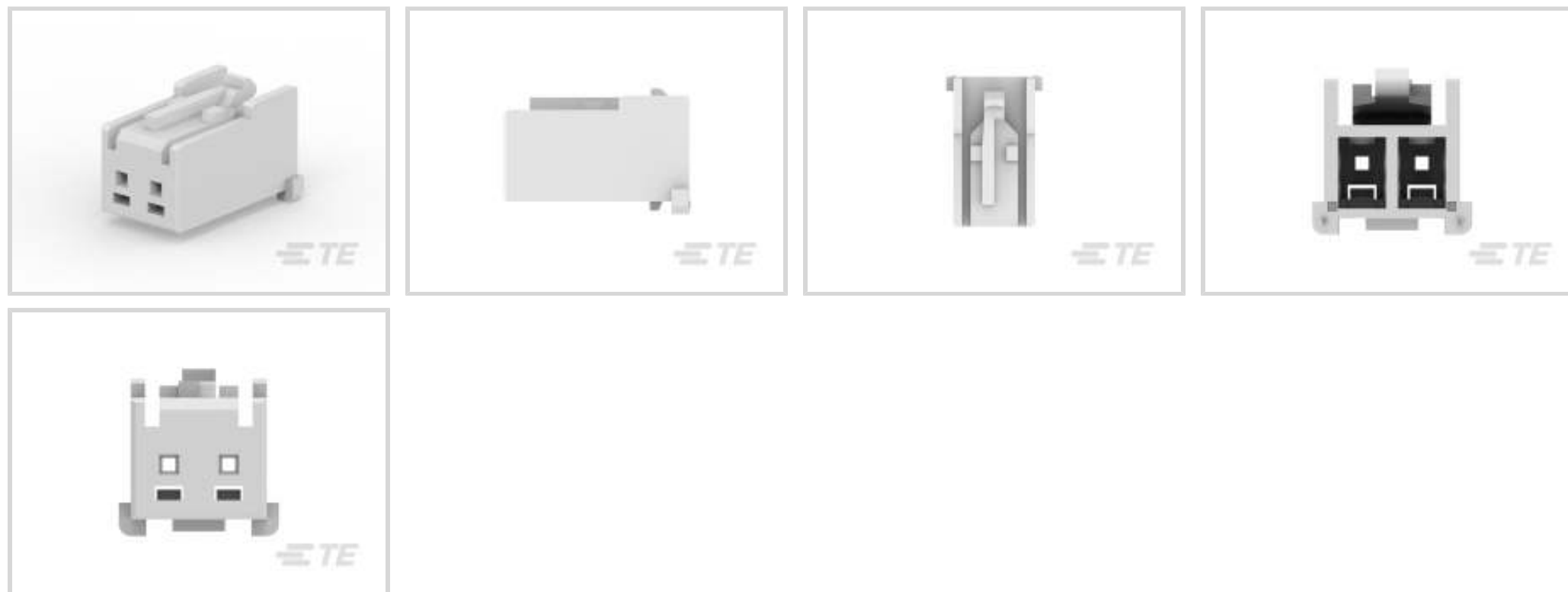

Connector Product Type: **Housing**

Connector & Housing Type: **Plug**

Connector System: **Wire-to-Wire**

Number of Positions: **2**

Centerline (Pitch): **2.5 mm [ .098 in ]**

[All Glow Wire Sig GRACE INERTIA Plug \(20\)](#)

## Features

### Product Type Features

Connector Product Type	Housing
Connector & Housing Type	Plug
Connector System	Wire-to-Wire
Sealable	No
Connector & Contact Terminates To	Wire & Cable

### Configuration Features

Number of Positions	2
Number of Rows	1

### Electrical Characteristics

Operating Voltage	50 VAC
-------------------	--------

### Body Features

--	--



Connector & Keying Code	A
-------------------------	---

Primary Product Color	Natural
-----------------------	---------

### Contact Features

Contact Retention Within Housing	Without
----------------------------------	---------

Contact Layout	Inline
----------------	--------

Contact Type	Tab
--------------	-----

Contact Base Material	Copper Alloy
-----------------------	--------------

Contact Current Rating (Max)	3 A
------------------------------	-----

### Termination Features

Termination Method to Wire & Cable	Crimp
------------------------------------	-------

### Mechanical Attachment

Strain Relief	Without
---------------	---------

Panel Mount Feature	Without
---------------------	---------

PCB Mount Retention	Without
---------------------	---------

Mating Retention Type	Latch
-----------------------	-------

Mating Retention	With
------------------	------

Connector Mounting Type	Cable Mount (Free-Hanging)
-------------------------	----------------------------

### Housing Features

Housing Entry Configuration	Both Ends Closed
-----------------------------	------------------

Housing Material	PA 66 GF
------------------	----------

Centerline (Pitch)	2.5 mm[.098 in]
--------------------	-----------------

### Dimensions

	.224 in
--	---------

Connector Height	5.88 mm[.231 in]
------------------	------------------

Wire Size	.081 – .326 mm <sup>2</sup>
-----------	-----------------------------

### Usage Conditions

Operating Temperature Range	-30 – 105 °C[-22 – 221 °F]
-----------------------------	----------------------------

### Operation/Application

Circuit Application	Power & Signal
---------------------	----------------

### Industry Standards

Glow Wire Rating	Glow Wire
------------------	-----------

UL Flammability Rating	UL 94V-0
------------------------	----------



### Packaging Features

Packaging Quantity	400
Packaging Method	Bag & Box

### Other

Discrete Wire Connector Comment	Mating with 2-1971798-X
---------------------------------	-------------------------

### Product Compliance

[For compliance documentation, visit the product page on TE.com>](#)

EU RoHS Directive 2011/65/EU	Compliant
EU ELV Directive 2000/53/EC	Compliant
China RoHS 2 Directive MIIT Order No 32, 2016	No Restricted Materials Above Threshold
EU REACH Regulation (EC) No. 1907/2006	Current ECHA Candidate List: JUNE 2023 (235) Candidate List Declared Against: JAN 2023 (233) Does not contain REACH SVHC
Halogen Content	Not Low Halogen - contains Br or Cl > 900 ppm.
Solder Process Capability	Not reviewed for solder process capability

#### Product Compliance Disclaimer

This information is provided based on reasonable inquiry of our suppliers and represents our current actual knowledge based on the information they provided. This information is subject to change. The part numbers that TE has identified as EU RoHS compliant have a maximum concentration of 0.1% by weight in homogenous materials for lead, hexavalent chromium, mercury, PBB, PBDE, DBP, BBP, DEHP, DIBP, and 0.01% for cadmium, or qualify for an exemption to these limits as defined in the Annexes of Directive 2011/65/EU (RoHS2). Finished electrical and electronic equipment products will be CE marked as required by Directive 2011/65/EU. Components may not be CE marked. Additionally, the part numbers that TE has identified as EU ELV compliant have a maximum concentration of 0.1% by weight in homogenous materials for lead, hexavalent chromium, and mercury, and 0.01% for cadmium, or qualify for an exemption to these limits as defined in the Annexes of Directive 2000/53/EC (ELV). Regarding the REACH Regulation, the information TE provides on SVHC in articles for this part number is based on the latest European Chemicals Agency (ECHA) 'Guidance on requirements for substances in articles' posted at this URL: <https://echa.europa.eu/guidance-documents/guidance-on-reach>

### Compatible Parts



TE Part # CAT-G7534A-H342  
STD Temp Sig GRACE INERTIA Header



TE Part # CAT-G7534A-C1701  
STD Temp Sig GRACE INERTIA Cap



TE Part # 1903391-1  
GIC 2.5 W CAP HSG 2P NATURAL



TE Part # 1-1903391-2  
GIC 2.5 W CAP HSG 2P RED



TE Part # 2-1971794-2  
GIC2.5 TPA,2P



TE Part # 2-2232701-1  
NEW GI CONN2.5 PLUG HSG 2P NC



TE Part # 2232557-1  
NEW GI CONN2.5 REC. CONTACT

Also in the Series | GRACE INERTIA 2.5



Connector Contacts(2)



PCB Headers & Receptacles(138)

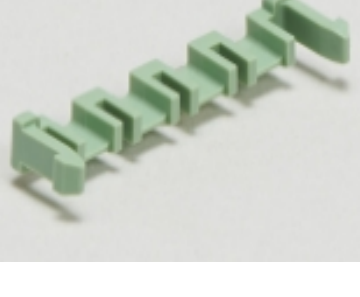

PCB Latches, Locks & Retainers(5)



Rectangular Connector Housings(49)



Rectangular Connector Locking(2)



Rectangular Power Connectors(35)

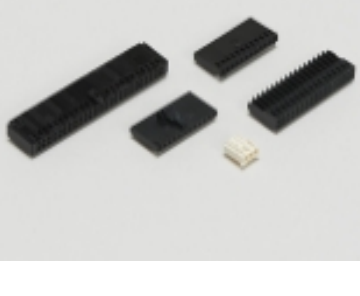

Wire-to-Board Connector Assemblies & Housings(46)



Wire-to-Board Connector Contacts(4)

Customers Also Bought



TE Part #1-1355200-1  
MCP2,8BU-GEH ASSY2P



TE Part #1487596-1  
USB, A-B, 28/24, BLACK, 2.0M



TE Part #66024-2  
TAB,PIDG TERMI-BK 16-14

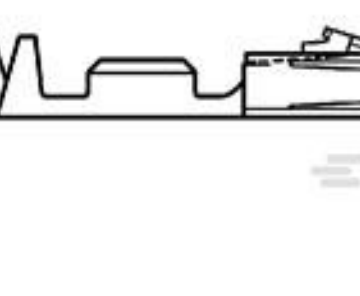

TE Part #1-104480-7  
SHORT POINT CONT PLTD SN



TE Part #640907-1  
RECEPT,PIDG FASTON 12-10 250



TE Part #1-963207-1  
4P J-P-TIM GEH KPL



TE Part #929937-3  
JPT REC 2.8 Contact SWS Sn



TE Part #163665-000  
S02-07-R



TE Part #60-0014-011-000  
CONTACT SOCKET 2 MM

## Documents

### Product Drawings

[NEW GI CONN2.5 PLUG HSG 2P NC](#)

English

### CAD Files

[3D PDF](#)

3D

Customer View Model

[ENG\\_CVM\\_CVM\\_2-1971793-1\\_J.2d\\_dxf.zip](#)

English

Customer View Model

[ENG\\_CVM\\_CVM\\_2-1971793-1\\_J.3d\\_igs.zip](#)

English

Customer View Model

[ENG\\_CVM\\_CVM\\_2-1971793-1\\_J.3d\\_stp.zip](#)

English

By downloading the CAD file I accept and agree to the [Terms and Conditions](#) of use.

### Datasheets & Catalog Pages

[5-1773465-3-GI2.5Flyer](#)

English

[7-1773465-8-GI2.5-ChineseFlyer](#)

### Product Specifications

[Application Specification](#)

English

### Product Environmental Compliance





## TE Material Declaration

English