

RECOMMENDED PCB HOLE LAYOUT

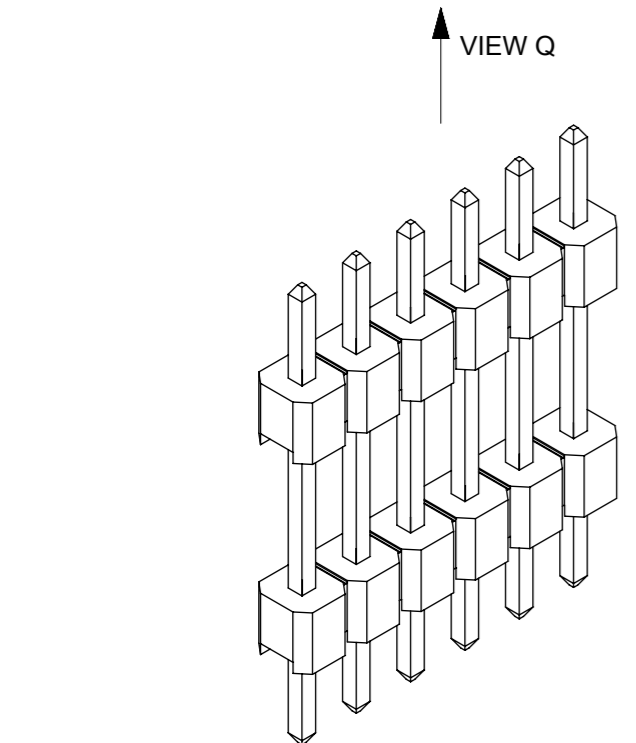
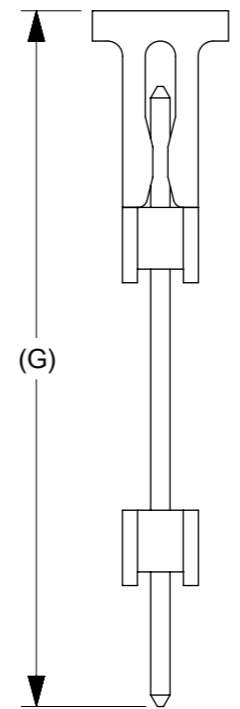
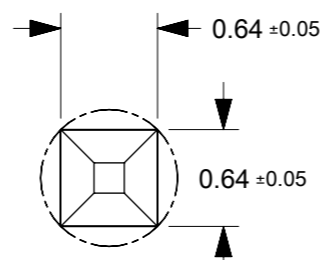
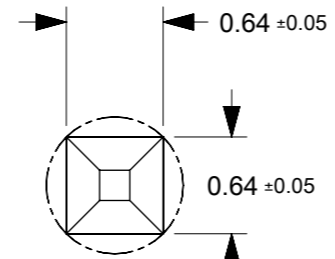
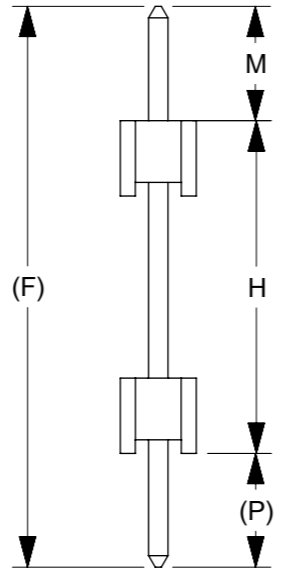
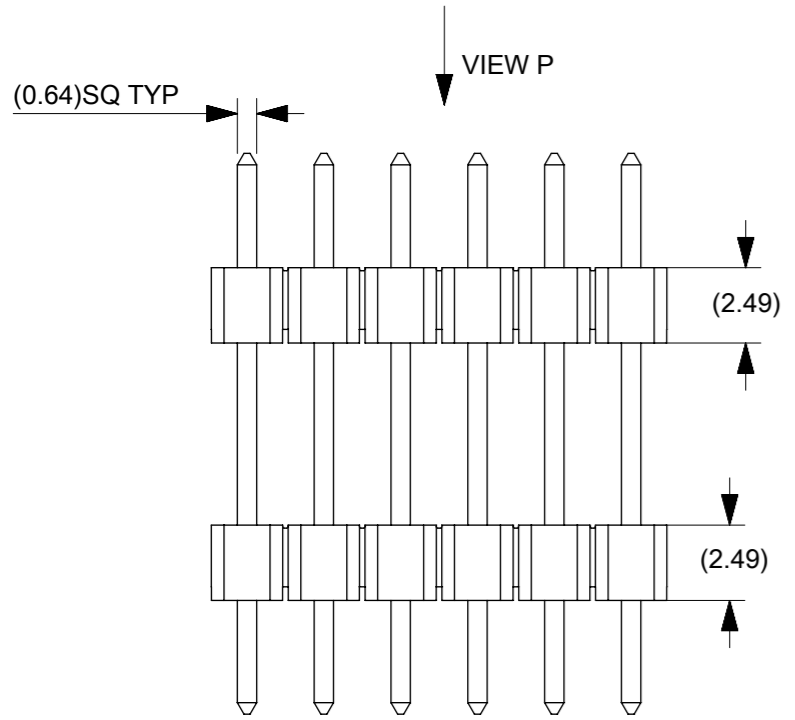

NOTES:

1. MATERIAL:
HOUSING: NYLON, GLASS FILLED, UL94V-0,
COLOR: BLACK
TERMINAL: 0.64MM SQ PIN, COPPER ALLOY
2. PLATING TYPE:
(1) : GOLD FLASH OVER
1.25µm MIN. NICKEL OVERALL.
(2) : 0.05 µm MIN. GOLD PLATE ON CONTACT AND
2.50 µm MIN. TIN ON SOLDER TAIL OVER
1.25 µm MIN. NICKEL OVERALL.
(3) : 0.38 µm MIN. GOLD PLATE ON CONTACT AND
2.00 µm MIN. TIN ON SOLDER TAIL OVER
1.25 µm MIN. NICKEL OVERALL.
(4) : 0.75 µm MIN. GOLD PLATE ON CONTACT AND
2.00 µm MIN. TIN ON SOLDER TAIL OVER
1.25 µm MIN. NICKEL OVERALL.
(5) : 2.50 µm MIN. TIN OVER
1.25 µm MIN. NICKEL OVERALL.
(6) : 0.75 µm MIN. GOLD PLATE ON CONTACT AND
SOLDER TAIL OVER 1.25 µm MIN. NICKEL OVERALL.
3. THE ABOVE 6 CKT IS FOR ILLUSTRATION PURPOSE ONLY.
4. PACKAGING TYPE: SEE TABLE
5. RECOMMENDED PCB THICKNESS 1.60MM.
6. PRODUCT SPECIFICATION: PS-87920-019
7. WAFER TO BE FLAT WITHIN 0.003mm/mm
IRREGULAR CIRCUIT CUTOFF WITHIN BREAKAWAY SECTION
8. IS PERMISSIBLE. CUTTING OR CHIPPING OF THE MAIN
BODY IS NOT ACCEPTABLE.
9. PARTS ARE NOT STACKABLE ON 2.54 CENTER
10. PACKAGING SPECIFICATION: SEE TABLE

THIS DRAWING CONTAINS INFORMATION THAT IS PROPRIETARY TO MOLEX ELECTRONIC TECHNOLOGIES, LLC AND SHOULD NOT BE USED WITHOUT WRITTEN PERMISSION									
DIMENSION UNITS		SCALE		CURRENT REV DESC:				molex	
mm		NTS							
GENERAL TOLERANCES (UNLESS SPECIFIED)				EC NO: 710024		CUSTOMER		CUSTOMER	
				DRWN: DANUSA 2022/05/26		2.54MM PITCH SINGLE ROW DUAL WAFER HEADER, T/H			
				CHK'D: DANUSA 2022/06/10		PRODUCT CUSTOMER DRAWING			
				APPR: MRAMAKRISHNA 2022/06/10					
				INITIAL REVISION:		DOCUMENT NUMBER		DOC TYPE	
				DRWN: SKLIM01 2006/03/10		SD-87937-007		PSD	
				APPR: MLONG 2010/01/14				000 B10	
DRAFT WHERE APPLICABLE MUST REMAIN WITHIN DIMENSIONS				THIRD ANGLE PROJECTION		DRAWING		SERIES	
				A3-SIZE		87937		MATERIAL NUMBER	
				SEE TABLE		GENERAL MARKET		SHEET NUMBER	
								1 OF 2	

F	PART NUMBERS	CKT SIZE	VOID POSITION	DIMENSION							PLATING OPTION	PACKAGING TYPE	PACKAGING SPECIFICATION
						MATING END	STACKER HEIGHT	SOLDER TAIL		WITH CAP			
				A	B	M	H	(P)	(F)	(G)			
	879370106	1	----	2.54	----	3.78	11.00	3.76	18.54	----	5	TRAY PACKED	PK-89990-489
	879370202	2	----	5.08	2.54	3.50	25.00	3.50	32.00	----	5	TRAY PACKED	PK-89990-489
	879370203	2	----	5.08	2.54	2.45	15.60	2.45	20.50	----	5	BULK PACKED	PK-89990-491
	879370206	2	----	5.08	2.54	3.78	11.00	3.76	18.54	----	5	TRAY PACKED	PK-89990-489
	879370302	3	----	7.62	5.08	11.70	8.50	11.70	31.90	----	5	TRAY PACKED	PK-89990-489
	879370306	3	----	7.62	5.08	10.50	20.80	3.00	34.30	35.50	3	TUBE PACKED	PK-89990-***
	879370311	3	----	7.62	5.08	3.00	6.00	3.00	12.00	----	5	TRAY PACKED	PK-89990-489
	879370303	3	----	7.62	5.08	2.40	5.80	2.40	10.60	----	5	BULK PACKED	PK-89990-491
E	879370304	3	----	7.62	5.08	4.00	12.50	4.00	20.50	----	5		
	879370305	3	----	7.62	5.08	3.00	7.00	3.00	13.00	----	5	TUBE PACKED	TBD
	879370306	3	----	7.62	5.08	10.50	20.80	3.00	34.30	35.50	3	TUBE PACKED	TBD
	879370307	3	----	7.62	5.08	2.40	17.50	3.00	22.90	27.00	5	TAPE & REEL	TBD
	879370309	3	----	7.62	5.08	6.00	9.00	3.00	18.00	----	5	TRAY PACKED	PK-89990-489
	879370406	4	----	10.16	7.62	3.78	11.00	3.76	18.54	----	5	TRAY PACKED	PK-89990-489
	879370402	4	----	10.16	7.62	2.65	11.50	2.41	16.56	----	3	TRAY PACKED	PK-89990-489
	879370502	5	----	12.70	10.16	3.78	11.00	3.76	18.54	----	5	TRAY PACKED	PK-89990-489
	879370503	5	----	12.70	10.16	4.00	12.50	4.00	20.50	----	5	BULK PACKED	PK-89990-491
D	879370504	5	----	12.70	10.16	11.00	25.00	2.50	38.50	----	3	TRAY PACKED	PK-89990-489
	879370505	5	----	12.70	10.16	6.00	11.80	2.40	20.20	----	3	TRAY PACKED	PK-89990-489
	879370602	6	----	15.24	12.70	3.00	8.90	3.00	14.90	----	5	TRAY PACKED	PK-89990-489
	879370701	7	----	17.78	15.24	8.80	22.19	2.79	33.78	----	2	TRAY PACKED	PK-89990-489
	879370800	8	----	20.32	17.78	9.00	12.00	3.00	24.00	----	5	TRAY PACKED	PK-89990-489
	879370802	8	----	20.32	17.78	3.78	11.00	3.76	18.54	----	5	TRAY PACKED	PK-89990-489
	879370803	8	----	20.32	17.78	3.00	8.90	3.00	14.90	18.40	5	TAPE & REEL	TBD
	879371000	10	----	25.40	22.86	8.15	25.00	3.05	36.20	----	3	TRAY PACKED	PK-89990-489
	879371004	10	----	25.40	22.86	8.00	17.80	5.20	31.00	----	3	TRAY PACKED	PK-89990-489
C	879371008 (B10)	10	----	25.40	22.86	8.00	18.50	8.00	34.50	----	7	TRAY PACKED	PK-89990-489
	879371206	12	----	30.48	27.94	3.78	11.00	3.76	18.54	----	5	TRAY PACKED	PK-89990-489
	879371208	12	----	30.48	27.94	3.50	18.00	3.50	25.00	----	5	TRAY PACKED	PK-89990-489
	879371406	14	----	35.56	33.02	3.78	11.00	3.76	18.54	----	5	TRAY PACKED	PK-89990-489
	879371600	16	----	40.64	38.10	12.70	17.63	5.99	36.32	----	3	BULK PACKED	PK-89990-491
	879371601	16	----	40.64	38.10	11.94	19.05	2.79	33.78	----	3	BULK PACKED	PK-89990-491
	879371602	16	----	40.64	38.10	2.14	8.70	2.16	13.00	----	5	BULK PACKED	PK-89990-491
	879371606	16	----	40.64	38.10	3.78	11.00	3.76	18.54	----	5	TRAY PACKED	PK-89990-489
	879371801	18	----	45.72	43.18	3.00	13.20	3.00	19.20	----	5	TBD	----
B	879372201	22	2, 3, 5, 6, 8, 9, 11, 12, 14, 15, 17, 18, 20, 21	55.88	53.34	3.00	18.00	3.00	24.00	----	5	TRAY PACKED	PK-89990-489
	879372800	28	----	71.12	68.58	4.00	12.50	4.00	20.50	----	5	BULK PACKED	PK-89990-491

NOTE:
 F.G P/N: 87937-1008 (10-ckt)
 (7): PLATING: 0.38um GOLD PLATING
 ON BOTH MATING END & SOLDER TAIL (8mm)
 1.25um MIN. NICKLE OVERALL

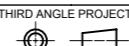
THIS DRAWING CONTAINS INFORMATION THAT IS PROPRIETARY TO MOLEX ELECTRONIC TECHNOLOGIES, LLC AND SHOULD NOT BE USED WITHOUT WRITTEN PERMISSION											
DIMENSION UNITS		SCALE		CURRENT REV DESC:							
mm		NTS		 CUSTOM HEADER 2.54MM PITCH SINGLE ROW DUAL WAFER HEADER, T/H PRODUCT CUSTOMER DRAWING DOCUMENT NUMBER: SD-87937-007 DOC TYPE: PSD DOC PART: 000 REVISION: B10 MATERIAL NUMBER: SEE TABLE CUSTOMER: GENERAL MARKET SHEET NUMBER: 2 OF 2							
GENERAL TOLERANCES (UNLESS SPECIFIED)											
		MM	INCH								
4 PLACES	±		±								
3 PLACES	±		±								
2 PLACES	±	0.2	±								
1 PLACE	±		±								
0 PLACES	±		±								
ANGULAR TOL ± 3.0°				EC NO: 710024 DRWN: DANUSA 2022/05/26 CHK'D: DANUSA 2022/06/10 APPR: MRAMAKRISHNA 2022/06/10 INITIAL REVISION: DRWN: SKLIM01 2006/03/10 APPR: MLONG 2010/01/14							
DRAFT WHERE APPLICABLE MUST REMAIN WITHIN DIMENSIONS				THIRD ANGLE PROJECTION		DRAWING		SERIES		MATERIAL NUMBER	
						A3-SIZE		87937		SEE TABLE	

DOCUMENT STATUS	P1	RELEASE DATE	2022/06/10	07:59:04
-----------------	----	--------------	------------	----------