



ZEPIR0BxS02MODG

ZMOTION® Detection Module II

Product Specification

PS030504-0917



Warning: DO NOT USE THIS PRODUCT IN LIFE SUPPORT SYSTEMS.

LIFE SUPPORT POLICY

ZILOG'S PRODUCTS ARE NOT AUTHORIZED FOR USE AS CRITICAL COMPONENTS IN LIFE SUPPORT DEVICES OR SYSTEMS WITHOUT THE EXPRESS PRIOR WRITTEN APPROVAL OF THE PRESIDENT AND GENERAL COUNSEL OF ZILOG CORPORATION.

AS USED HEREIN

Life support devices or systems are devices which (a) are intended for surgical implant into the body, or (b) support or sustain life and whose failure to perform when properly used in accordance with instructions for use provided in the labeling can be reasonably expected to result in a significant injury to the user. A critical component is any component in a life support device or system whose failure to perform can be reasonably expected to cause the failure of the life support device or system or to affect its safety or effectiveness.

DOCUMENT DISCLAIMER

©2017 Zilog, Inc All rights reserved. Information in this publication concerning the devices, applications, or technology described is intended to suggest possible uses and may be superseded. ZILOG, INC. DOES NOT ASSUME LIABILITY FOR OR PROVIDE A REPRESENTATION OF ACCURACY OF THE INFORMATION, DEVICES, OR TECHNOLOGY DESCRIBED IN THIS DOCUMENT. ZILOG ALSO DOES NOT ASSUME LIABILITY FOR INTELLECTUAL PROPERTY INFRINGEMENT RELATED IN ANY MANNER TO USE OF INFORMATION, DEVICES, OR TECHNOLOGY DESCRIBED HEREIN OR OTHERWISE. The information contained within this document has been verified according to the general principles of electrical and mechanical engineering.

ZMOTION® and Z8 Encore! XP™ are trademarks or registered trademarks of Zilog, Inc., an IXYS Company. All other product or service names are the property of their respective owners.

Revision History

Each instance in the following revision history table reflects a change to this document from its previous version. For more details, refer to the corresponding pages or appropriate links provided in the table.

Date	Revision Level	Description	Page Number
Sep 2017	04	Corrected ZMOTION Engine revision.	65
Sep 2014	03	Updated Table 10 to include PS0336 and change title of PS0286	58
May 2013	02	Updated mechanical drawings, Figures 9 and 10.	56 , 57
Mar 2013	01	Original issue.	All

Table of Contents

Revision History	iii
Table of Contents	iv
List of Figures	vii
List of Tables	viii
Architectural Overview	1
Features	1
ZEPiR0BxS02MODG Block Diagram	2
Pin Description	3
Operational Modes	3
Hardware Interface Mode	3
Serial Interface Mode	4
Setting Operation Mode	4
Signal Descriptions, Hardware Interface Mode	4
Ground	4
Supply Voltage	4
Delay	5
Sensitivity	5
Motion Detect	6
Light Gate	6
Sleep Mode	6
Signal Descriptions, Serial Interface Mode	6
Ground	6
Supply Voltage	7
Receive Data	7
Transmit Data	7
Motion Detect and Reset	7
Light Gate	7
Sleep Mode	8
Voltage Brown-Out Protection and Power-On Reset	8
Operation	10
Hardware Interface Mode	10
Sleep Mode in Hardware Interface Mode	11
Serial Interface Mode	11
Sleep Mode in Serial Interface Mode	12

Serial Interface Commands and Description	12
Serial Commands	15
Motion Status Command	17
Light Gate Level Commands	18
MD/RST Pin Configuration	21
MD Activation Time	23
Hyper Sense	25
Hyper Sense Level Setting	27
Frequency Response Setting	29
Motion Detection Suspend	31
Software Revision	33
Serial Interface Command Mode	35
Motion Detected Unsolicited Mode	37
MD Current Active Output Time	39
Ping	41
Range Setting	43
Sensitivity	45
Directional Detection	47
Module Reset	51
Sleep Mode	54
Detection Pattern	55
Mechanical Information	56
Related Documentation	58
Related Products	58
Electrical Characteristics	59
Absolute Maximum Ratings	60
Ordering Information	61
Part Numbers	61



Appendix A. Schematic Diagram	62
Appendix B. Hardware Interface Mode	63
Appendix C. Serial Interface Mode	64
Appendix D. Software Revisions	65
Index	66
Customer Support	70

List of Figures

Figure 1.	ZDMII Block Diagram (ZEPIR0BxS02MODG)	2
Figure 2.	The ZMOTION Detection Module II, Right-Angle Version (ZEPIR0BAS02MODG) 2	
Figure 3.	Power-On Reset Operation	9
Figure 4.	Voltage Brown-Out Reset Operation	9
Figure 5.	Read Command Structure	12
Figure 6.	Write Command Structure	13
Figure 7.	Confirmed Command Structure	14
Figure 8.	Detection Pattern	55
Figure 9.	Mechanical Drawing of the ZMOTION Detection Module II (Right-Angled Pins, ZEPIR0BAS02MODG) 56	
Figure 10.	Mechanical Drawing of the ZMOTION Detection Module II (Straight Pins, ZEPIR0BBS02MODG) 57	
Figure 11.	Schematic Diagram of ZMOTION Detection Module II	62
Figure 12.	Application Example, Hardware Interface Mode	63
Figure 13.	Application Example, Serial Interface Mode	64

List of Tables

Table 1.	Pin Description	3
Table 2.	Delay Time and Voltage on DLY	5
Table 3.	Summary of Serial Interface Commands	15
Table 4.	Shortcuts to Light Gate Level Commands	18
Table 5.	MD Output Activation Time Values	23
Table 6.	MD Output Activation Time Values	35
Table 7.	MD Output Activation Time Values	39
Table 8.	Shortcuts to Directional Detection Commands	47
Table 9.	Shortcuts to Module Reset Commands	51
Table 10.	ZMOTION Detection Module II Reference Design Documentation	58
Table 11.	Electrical Characteristics	59
Table 12.	Absolute Maximum Ratings	60
Table 13.	Part Numbers	61
Table 14.	ZMOTION Detection Module II Application Software Revision	65
Table 15.	ZMOTION Engine Revision	65

Architectural Overview

Zilog's ZMOTION® Detection Module II (ZDMII) is a complete motion detection solution ideally suited for applications that must detect a human presence. It is an excellent solution for detecting people as they approach entrances, kiosks, product displays, vending machines, appliances and advertising displays.

ZDMII is a board-level module that combines the unique features of Zilog's ZMOTION® (Z8FS040) microcontroller with a pyroelectric sensor and a clip-on lens. The pyroelectric sensor and clip-on Fresnel lens combine to provide a compact solution without sacrificing performance, plus the ability to change lenses provides the flexibility to suit a variety of applications. The module is only 25.5 mm x 16.7 mm (and only 11 mm thick), so it can easily fit into many size-constrained applications.

ZDMII is simple to use. It can operate in Hardware Mode – which simply activates an output signal when motion is detected – or in Serial Mode, allowing it to communicate with another processor in your system when greater control over motion detection performance is required. In both modes, sensitivity and output activation time can be controlled to match application requirements. For applications that require ambient light sensing, an input supporting an external light sensor is provided for gating motion detection output.

ZDMII provides an easy, low-risk solution for your motion detection requirements.

Features

Key features of the ZDMII include:

- Complete low-profile motion detection solution
- Small form factor: 25.5 mm x 16.7 mm
- Ranges up to 7m with a 95-degree detection pattern
- Simple-to-use Hardware Mode or advanced Serial Mode (UART)
- Flexible control over sensitivity and output activation time
- Sleep Mode for low-power applications
- Support for Ambient Light Sensor input
- Unique Hyper Sense feature automatically increases sensitivity after motion is detected
- Minimal components ensure high reliability
- Application code can be modified to support custom solutions
- Complete evaluation system available

- 8-pin interface connector with two orientations available (right-angle and straight)
- Operates from a 2.8V to 3.6V power supply
- Standard operating temperature range: 0°C to 70°C

ZEPIR0BxS02MODG Block Diagram

Figure 1 shows a block diagram of the ZMOTION® Detection Module II.

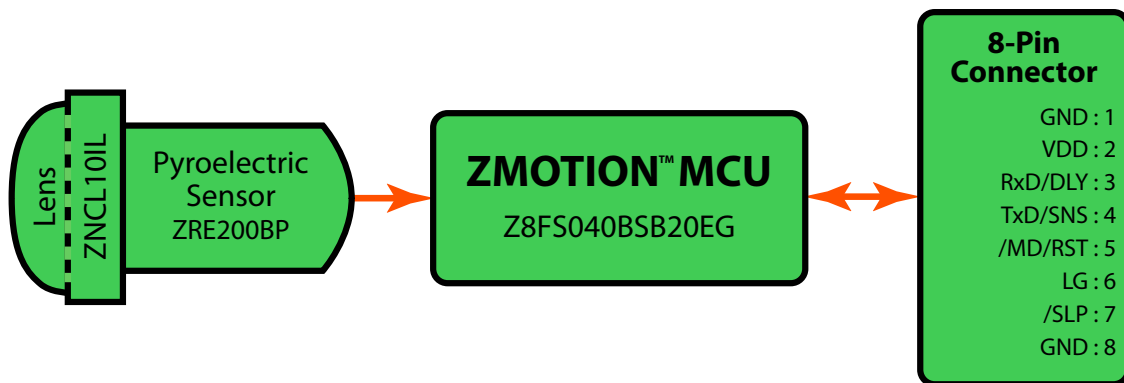

Figure 1. ZDMII Block Diagram (ZEPIR0BxS02MODG)

Figure 2 shows the right-angle version of the ZDMII Module.



Figure 2. The ZMOTION Detection Module II, Right-Angle Version (ZEPIR0BAS02MODG)

Pin Description

Table 1 lists the pin and signal descriptions per mode for ZDMII.

Table 1. Pin Description

Pin#	Signal Name	Hardware Interface Mode	Serial Interface Mode	Comments
1	GND	Ground	Ground	—
2	V _{DD}	Supply Voltage	Supply Voltage	—
3	RXD/DLY	Delay (DLY; analog input)	RXD — Receive Data (digital input)	—
4	TXD/SNS	—Sensitivity (SNS; analog input)	TXD — Transmit Data (digital output)	Mode Select during reset
5	$\overline{\text{MD}}/\overline{\text{RST}}$	Motion Detect (digital output)	Configurable: Reset ($\overline{\text{RST}}$; digital input); Motion Detect (MD; digital input)	Default is Reset ($\overline{\text{RST}}$) in Serial Interface Mode.
6	LG	Light Gate (analog input)	Light Gate (analog input)	If unused, connect to V _{DD} .
7	$\overline{\text{SLP}}/\overline{\text{DBG}}$	Sleep ($\overline{\text{SLP}}$; digital input)	Sleep ($\overline{\text{SLP}}$; digital input)	DBG is used for programming and debug.
8	GND	Ground	Ground	—

Operational Modes

ZDMII operates in both Hardware Interface and Software Interface modes; each is described in this section.

Hardware Interface Mode

- Provides basic configuration via the hardware interface pins
- Allows you to adjust sensitivity and delay
- Offers optional ambient light input
- Includes a Sleep Mode to reduce power consumption

Serial Interface Mode

- Provides advanced configuration and status via a serial interface
- \overline{MD} , LG and \overline{SLP} remain functional
- The serial interface runs at: 9600 bps, no parity, 8 data bits, 1 stop bit and no flow control

Setting Operation Mode

This section briefly outlines how to set Module operation in either Serial Interface or Hardware Interface modes.

Serial Interface Mode Selection

To select Serial Interface Mode, provide a pull up resistor from TXD/SNS to V_{DD} during power ON or when exiting Sleep Mode (typically 100K Ω). The device detects that the voltage on the pin is greater than 2.5V and enables the TXD and RXD signals. \overline{MD} , LG and \overline{SLP} remain active also. This resistor will have no effect on the transmitted data.

Hardware Interface Mode Selection

The Hardware Interface Mode is selected when TXD/SNS is between 0V and 1.8V during power ON or when exiting Sleep Mode.

For examples of using ZDMII in Hardware and Serial Interface Modes, see [Appendix B. Hardware Interface Mode](#) on page 63 and [Appendix C. Serial Interface Mode](#) on page 64.

Signal Descriptions, Hardware Interface Mode

This section describes the signals for operating in Hardware Interface Mode.

Ground

Both Pin 1 and the Pin 8 ground (GND) signals are tied together on the ZMOTION® Detection Module II and are connected to power ground.

Supply Voltage

The supply voltage (V_{DD}) provides power to ZDMII via Pin 2. For power consumption details, see the [Electrical Characteristics](#) chapter on page 59.

Delay

A high-impedance analog input, Pin 3 (RXD/DLY), sets the duration for the Motion Detect (\overline{MD}) pin to remain active when motion has been detected. Provide a voltage between 0V and 2V to select a delay of 2 seconds to 15 minutes (see Table 2). Typically, a simple resistor divider or trim pot is used to set the voltage.

Table 2. Delay Time and Voltage on DLY

Delay Time	Voltage on DLY
2 sec	0V
5 sec	0.2V
10 sec	0.4V
30 sec	0.6V
1 min	0.8V
2 min	1.0V
3 min	1.2V
5 min	1.4V
10 min	1.6V
15 min	1.8V

Sensitivity

A high-impedance analog input, Pin 4 (TXD/SNS) sets the Module's sensitivity to motion. Provide a voltage between 0V and 1.8V to adjust the sensitivity to meet the application requirements. A lower voltage means higher sensitivity. Typically, a simple resistor divider or trim pot is used to set the voltage.

- 1.8V = lowest sensitivity
- 0V = highest sensitivity

This signal also determines the interface mode of the Module. At power ON, and when exiting Sleep Mode, the signal is sampled; if it is greater than 2.5V (for example, pulled to V_{DD} via resistor), then the system enters Serial Interface Mode and the pin is converted to TXD. If the signal is between 0V and 1.8V, Hardware Interface Mode is selected.

Motion Detect

An active Low output, Pin 5 ($\overline{\text{MD}}$) is activated when motion is detected. The duration in which this signal remains active is set by the DLY signal. This signal is actively driven High.

- 0 = motion detected
- 1 = no motion detected

Light Gate

A high-impedance analog input, Pin 6 (LG), should be provided with a voltage that is proportional to the amount of ambient light in the environment (typically provided via a CDS photocell or similar circuit). The signal is used internally to gate the $\overline{\text{MD}}$ output signal such that it does not activate in the presence of daytime ambient light. When the voltage on this pin is lower than 1.0V, the $\overline{\text{MD}}$ signal will not activate even when motion is detected. If $\overline{\text{MD}}$ is in an active state when LG transitions below 1.0V, the current DLY duration is completed before $\overline{\text{MD}}$ is deactivated. If LG is unused, connect to V_{DD} .

- GND to 1.0V = $\overline{\text{MD}}$ does not activate when motion is detected
- 1.0V to V_{DD} = $\overline{\text{MD}}$ is activated when motion is detected

Sleep Mode

Pin 7 ($\overline{\text{SLP}}$) is an active Low digital input. When at logic 0, the Module enters low-power Sleep Mode. The Module does not detect any motion and $\overline{\text{MD}}$ is driven inactive. When SLP is at logic 1, the Module exits Sleep Mode and begins detecting motion. This signal must be held at logic 1 during power ON.

- 0 = module disabled; low-power Sleep Mode is active
- 1 = normal operation

Signal Descriptions, Serial Interface Mode

This section describes the signals for operating in Serial Interface Mode.

Ground

Both Pin 1 and Pin 8 ground (GND) signals are tied together on the ZDMII Module and are connected to power ground.

Supply Voltage

The supply voltage (V_{DD}) provides power to the Module via Pin 2. For power consumption details, see the [Electrical Characteristics](#) chapter on page 59.

Receive Data

This Pin 3 (RXD/DLY) input is the asynchronous serial input used for sending commands and configuration to the Module. It operates at 9600 bps, no parity, 8 data bits, 1 stop bit and no flow control. For a list and description of the commands supported, see [Table 3](#) on page 14.

Transmit Data

This Pin 4 (TXD/SNS) output is the asynchronous serial data output from the Module in response to commands and configuration supplied on the RXD line. It operates at 9600 bps, no parity, 8 data bits and 1 stop bit. For more information about the serial command interface, see the [Serial Interface Commands and Description](#) section on page 12.

This signal also determines the interface mode of the Module. At power ON, and when exiting Sleep Mode, the signal is sampled; if it is higher than 2.5 V (for example, pulled to V_{DD} via resistor), then the system enters Serial Interface Mode. If the signal is at a value between 0 V and 1.8 V, Hardware Interface Mode is selected.

Motion Detect and Reset

An active Low output, Pin 5 ($\overline{MD}/\overline{RST}$), is activated when motion is detected. The duration in which this signal remains active is set by the DLY signal. This signal is actively driven High.

- 0 = motion detected
- 1 = no motion detected

As \overline{RST} , this pin provides an active Low hardware reset signal for the Module. The function of this pin is selected by the C serial command. The default value for this pin is \overline{RST} .

Light Gate

A high-impedance analog input, Pin 6 (LG), is used internally to gate the \overline{MD} signal such that it does not activate in the presence of daytime ambient light. The voltage applied to this pin should be proportional to the amount of ambient light in the environment (typically provided via a CDS photocell or similar circuit).

- $LG >$ Light Gate Threshold Register — \overline{MD} is activated when motion is detected
- $LG <$ Light Gate Threshold Register — \overline{MD} does not activate when motion is detected

If \overline{MD} is in an active state when LG transitions above the programmed value, the current DLY time is completed before \overline{MD} is deactivated.

If LG is unused, connect to V_{DD} .

Sleep Mode

Pin 7 (\overline{SLP}) is an active Low digital input. When at logic 0, the Module enters low-power Sleep Mode. The Module does not detect any motion and \overline{MD} is driven inactive. When \overline{SLP} is at logic 1, the Module exits Sleep Mode and begins detecting motion. This signal must be held at logic 1 during power ON.

- 0 = module disabled; low-power Sleep Mode is active
- 1 = normal operation

Voltage Brown-Out Protection and Power-On Reset

ZDMII contains an internal Reset Controller with a Power-On Reset (POR) circuit and Voltage Brown-Out (VBO) protection to ensure proper operation. When power is first applied, the POR circuit monitors the supply voltage and holds the Module's MCU in the Reset state until the supply voltage reaches a safe operating level. After the supply voltage exceeds the POR voltage threshold (V_{POR}), the MCU is released and the Module begins operating. A further delay of typically 20 seconds is included to allow the pyroelectric sensor to stabilize. This value varies depending on environmental conditions. After this delay, the system begins to look for motion. Prior to this delay, the \overline{MD} signal remains inactive.

Figure 3 shows Power-on Reset operation. See the [Electrical Characteristics](#) chapter on page 59 for the POR voltage threshold (V_{POR}).

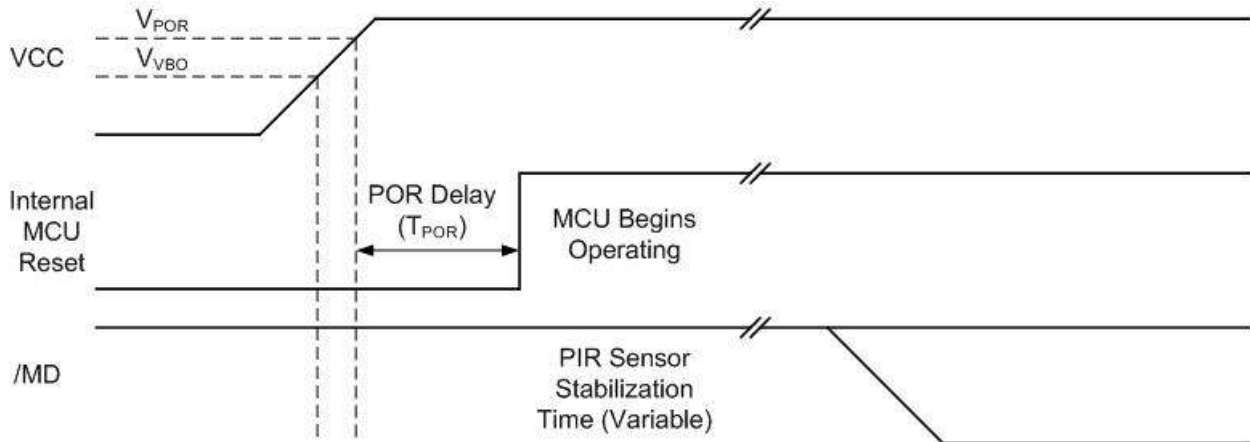

Figure 3. Power-On Reset Operation

ZDMII provides low Voltage Brown-Out protection to ensure proper operation when the supply voltage drops below an unsafe level – below the VBO voltage threshold. The VBO circuit senses this condition and forces the Module into the Reset state. While the supply voltage remains below the POR voltage threshold (V_{POR}), the VBO block holds the Module in the Reset.

After the supply voltage again exceeds the Power-On Reset voltage threshold, the Module progresses through a full Power-On Reset sequence, as described in the Power-On Reset section. Figure 4 shows the Voltage Brown-Out operation. See the [Electrical Characteristics](#) chapter on page 59 for the VBO voltage threshold (V_{VBO}).

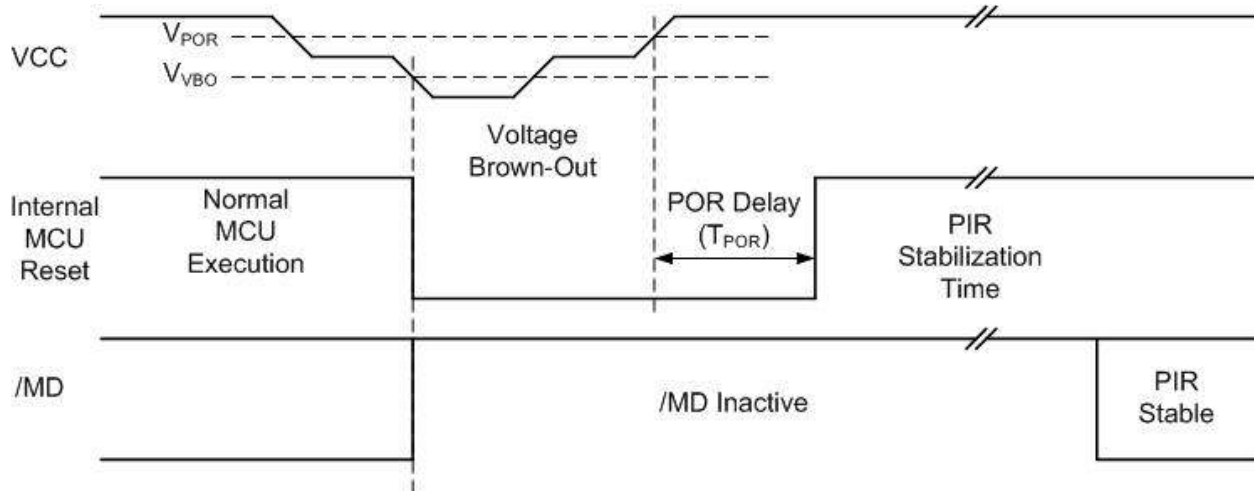

Figure 4. Voltage Brown-Out Reset Operation

Operation

When power is applied, the TXD/SNS pin is sampled to determine the mode of operation. If the signal is above 2.5V, Serial Interface Mode is entered. If the signal is between 0V and 1.8V Hardware Interface Mode is entered. During this time, the pyroelectric sensor is monitored, and the device waits for it to stabilize. After this stabilization period is complete, the device starts normal operation in the selected mode. In Hardware Interface Mode, the DLY, SNS, LG and $\overline{\text{SLP}}$ signals are sampled regularly. In Serial Interface Mode, TXD/RXD are used to communicate with the device and LG, $\overline{\text{SLP}}$ and $\overline{\text{MD}}$ also provide their defined functions.

Hardware Interface Mode

This mode of operation is selected when the SNS pin is at a value between 0V and 1.8V during power ON (or after a reset caused by V_{BO}). After Hardware Interface Mode has been established, this pin becomes the sensitivity input and accepts a voltage between 0V and 1.8V to set the motion detection sensitivity level.

- 0V = highest sensitivity
- 1.8V = lowest sensitivity

These sensitivity levels are normally achieved with a simple resistor divider or potentiometer resistor divider.

After application of power, the PIR sensor is allowed to stabilize. At this point, the MCU waits for the PIR sensor to stabilize; this period is typically 20 seconds but varies depending on environmental conditions. The software dynamically monitors the pyroelectric sensor during power up and begins detecting motion as soon as the sensor is stable.

The $\overline{\text{MD}}$ (Motion Detect) pin is driven active (Low) when motion is detected. The duration in which the signal remains active is determined by the voltage on the delay pin and can be set to a value between 2 seconds and 15 minutes. See [Table 2](#) on page 5.

The Light Gate signal acts as a disable (gate) for the $\overline{\text{MD}}$ signal. In a typical application, this signal is a representation of the ambient light in the environment. If there is light detected, the $\overline{\text{MD}}$ signal does not activate, even in the presence of motion. For an example showing how to use ZDMII in Hardware Interface Mode, see [Appendix B. Hardware Interface Mode](#) on page 63.

Sleep Mode in Hardware Interface Mode

For applications in which motion detection is not always required, the Sleep signal can be used to put the device into a low-power mode. The advantage of this feature vs. removing power from the Module is that the PIR stabilization time is much shorter.

If the Sleep ($\overline{\text{SLP}}$) input signal is driven Low, the device enters a low-power Sleep Mode and is awakened by deactivating the signal (driving the signal High).

Serial Interface Mode

Serial Interface Mode is implemented as a superset of the features available in Hardware Interface Mode. The interfacing device (Host) has an expanded feature set and more flexibility with many of those features. The interface is designed to be simple to implement on the host processor and use as few resources as possible.

This mode of operation is selected when the SNS pin is above 2.5V during power ON (or after a reset caused by V_{BO}). Typically this signal is tied to V_{DD} through a pull-up resistor. After Serial Interface Mode has been established, this pin becomes the Transmit Data (TXD) output and is used to send responses to commands given to the device.

The serial interface is asynchronous and is set to:

- 9600 baud
- No parity
- 8 data bits
- 1 stop bit
- No flow control

In Serial Interface Mode, commands are sent to the device over the RXD input pin and responses are sent from the device over the TXD output pin. The other signals on the device ($\overline{\text{MD}}$, LG, $\overline{\text{SLP}}$) remain active in Serial Interface Mode.

Motion Detect ($\overline{\text{MD}}$) output is driven active for the time set by the Output Activation Time command when motion is detected. The signal is also gated by the Light Gate (LG) input. For an example of how to use ZDMII in Serial Interface Mode, see [Appendix B. Hardware Interface Mode](#) on page 63.

Sleep Mode in Serial Interface Mode

For applications in which motion detection is not always required, the Sleep signal can be used to put the device into a low-power mode. The advantage of this feature vs. removing power from the Module is that the PIR stabilization time is much shorter.

If the Sleep ($\overline{\text{SLP}}$) input signal is driven Low, the device enters a low-power Sleep Mode and is awakened by either deactivating the signal (driving the signal High) or sending a character over the serial interface; the character is received and processed.

Serial Interface Commands and Description

The Serial Interface operates as a Host/Client relationship in which the Module is the client. Commands are sent from the Host and the Module responds with the requested information or confirmation. The only exception is when the Module is configured for *MD Unsolicited* operation. In this mode, the Module will send *Motion Detected* information without first receiving a command from the host. All commands sent to ZDMII are in ASCII character format; however, the data sent to and from the Module may be in ASCII or decimal formats.

There are three types of command structures accepted by ZDMII; each is described in this section.

- Read commands
- Write commands
- Confirmation commands

Read Command Structure

Read commands are used to request information from ZDMII, and are sent from the Host. The Module responds with the requested data.

- All Read commands are initiated by single lower-case letters.
- When a Read command is received, the Module returns the applicable value, as described in the [Serial Commands](#) chapter on page 15. See the example in Figure 5.

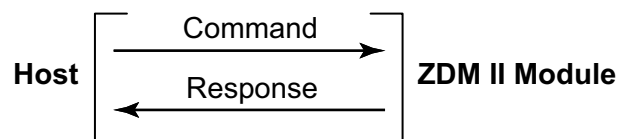

Figure 5. Read Command Structure

Write Command Structure

Write commands are used to update the configuration of ZDMII, and are sent from the Host. The Module responds with the current value as an acknowledgment. The Host then sends the new data and the Module responds with an ACK.

- All write commands are initiated by single upper-case letters.
- After a write command is received, the device returns the current value and expects an appropriate single-byte data value.
- When the data value is received, the device returns an ACK. If no data is received after the inactivity time-out period of 2.5 seconds, the device returns a NACK. See the example in Figure 6.

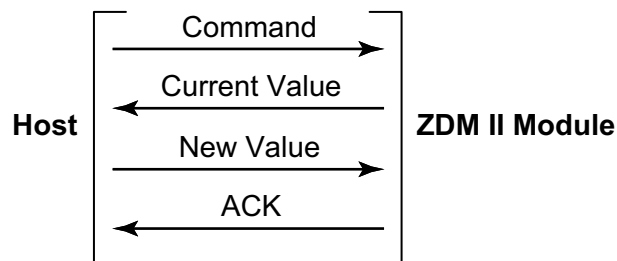

Figure 6. Write Command Structure

Confirmed Command Structure

Certain commands require a specific sequence of characters to be sent to prevent accidental initiation. These commands require a 4-character confirmation sequence. After a command requiring confirmation is received, the device returns an ACK.

- If the sequence is correct, the device returns an ACK and executes the command.
- If the sequence is incorrect, or if there is an inactivity delay of more than 2.5 seconds between any characters of the sequence, the device immediately sends a NACK and does not execute the command. See the example in Figure 7.

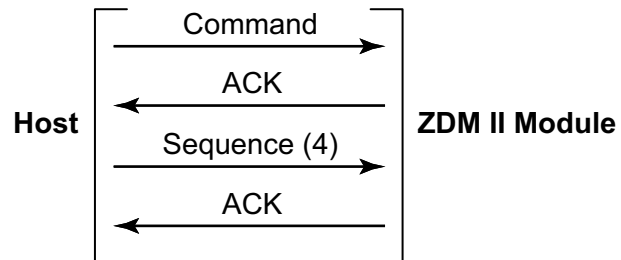

Figure 7. Confirmed Command Structure

► **Note:** ACK = 0x06 (ASCII ACK character).

NACK = 0x15 (ASCII NACK character). The Module will respond with a NACK on all unrecognized commands, and when commands requiring data (that is, Write, Clear, and Confirmation types) do not receive the required data within the inactivity time-out period.

Serial Commands

The Serial Interface commands are summarized in Table 3, and are each described in this section.

Table 3. Summary of Serial Interface Commands

Command	Name	Value [Default]	Command	Name	Value [Default]
0x43-'C'	Write MD/RST Pin Configuration	'M', 'R'	0x64-'d'	Read MD Activation Time	0–255 [2]
0x44-'D'	Write MD Activation Time	0–255	0x65-'e'	Read Hyper Sense Setting	'Y', 'N' [N]
0x45-'E'	Write Hyper Sense Setting	'Y', 'N'	0x66-'f'	Read Frequency Response Setting	'H', 'L' [L]
0x46-'F'	Write Frequency Response Setting	'H', 'L'	0x67-'g'	Read Hyper Sense Level	0–3 [1]
0x47-'G'	Write Hyper Sense Level	0–3	0x68-'h'	Read Motion Detection Suspend Setting	'Y', 'N' [N]
0x48-'H'	Write Motion Detection Suspend Setting	'Y', 'N'	0x69-'i'	Read Module Software Revision	0–255, 0–255 [6,4]
0x4B-'K'	Write Serial Interface Command Mode	'D', 'A'	0x6B-'k'	Read Serial Interface Command Mode	'D', 'A' [D]
0x4C-'L'	Write Light Gate Threshold	0–255	0x6C-'l'	Read Light Gate Threshold	0–255 [100]
0x4F-'O'	Write MD Output State	0–255	0x6D-'m'	Read Motion Detected Unsolicited Mode	'Y', 'N' [N]
0x50-'P'	Write Ping Value	0–255	0x4D-'M'	Write Motion Detected Unsolicited Mode	'Y', 'N'
0x52-'R'	Write Range Setting	0–7	0x6F-'o'	Read MD Current Output Active Time	0–255 [0]
0x53-'S'	Write Sensitivity	0–255	0x70-'p'	Read Ping Value	0–255 [1]
0x55-'U'	Write Dual Directional Mode	'Y', 'N'	0x72-'r'	Read Range Setting	0–7 [2]
0x58-'X'	Module Reset	'1', '2', '3', '4'	0x73-'s'	Read Sensitivity	0–255 [16]
0x59-'Y'	Write Sleep Time	0–255	0x75-'u'	Read Dual Directional Mode	'Y', 'N' [N]

Table 3. Summary of Serial Interface Commands (Continued)

Command	Name	Value [Default]	Command	Name	Value [Default]
0x5A-'Z'	Sleep Mode	'1', '2', '3', '4'	0x76-'v'	Read Single Directional Mode	'A', '+', '-' [A]
0x61-'a'	Read Motion Status	'Y', 'N', 'U'	0x56-'V'	Write Single Directional Mode	'A', '+', '-'
0x62-'b'	Read Current Light Gate Input Level	0-255	0x79-'y'	Read Sleep Time	0-255 [0]
0x63-'c'	Read MD/RST Pin Configuration	'M', 'R' [R]			

Motion Status Command

The current status of detected motion can be read and cleared through this command. When motion has been detected the value is set to 'Y' and latched until read with the 'a' command. Once cleared, the status remains at 'N' until motion is again detected.

Read Motion Status

Command

'a' (0x61)

Description

The Read Motion Status command returns the current status of detected motion. The current status is set to 'N' when read.

Return Values

'Y' = Motion detected

'N' = No motion detected

'U' = PIR Sensor has not stabilized after power-up

Normal Command Sequence

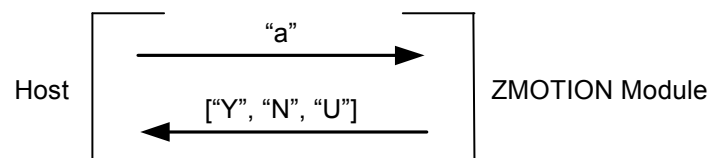

► **Note:** The returned value ('Y', 'N', 'U') is independent of the \overline{MD} output state or the \overline{MD} Activation Time (see commands 'o'/'O' and 'd'/'D').

Light Gate Level Commands

Light Gate Level commands control and monitor the signal associated with the Light Gate (LG) pin, and they are typically relative to the ambient light detected by an externally connected CDS photocell. The range is 0 to 255, with 0 indicating maximum ambient light and, 255 indicating minimum ambient light. See [Appendix B. Hardware Interface Mode](#) on page 63 and [Appendix C. Serial Interface Mode](#) on page 64 for recommended CDS photocell connections. The 'b' command reads the current signal level present on the pin.

The 'L' command sets the Light Gate Threshold value. This value is used in conjunction with the signal on the LG pin to internally gate the \overline{MD} signal such that it does not activate in the presence of ambient light. When the signal on the Light Gate (LG) pin is below this value, the \overline{MD} output signal remains inactive even when motion has been detected. When the signal on the Light Gate (LG) pin is above this value, the \overline{MD} signal activates normally when motion has been detected.

Table 4 lists the pages in this section that describe their respective commands.

Table 4. Shortcuts to Light Gate Level Commands

Name	Command	Page
Read Current Light Gate Input Level	'b' (0x62)	18
Read Light Gate Threshold	'I' (0x6C)	19
Write Light Gate Threshold	'L' (0x4C)	19

Read Current Light Gate Input Level

Command

'b' (0x62)

Description

The 'b' command returns the current signal level present on the Light Gate (LG) pin.

Return Values

0–255 (decimal)

Normal Command Sequence

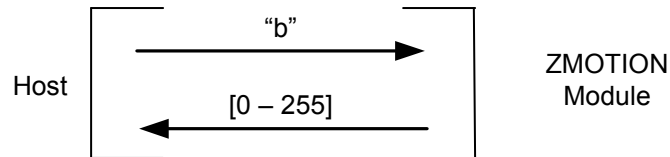

Read Light Gate Threshold

Command

'1' (0x6C)

Description

The '1' command returns the current Light Gate threshold value set by the Write Light Gate Threshold command.

Return Values

0-255 (decimal)

Normal Command Sequence

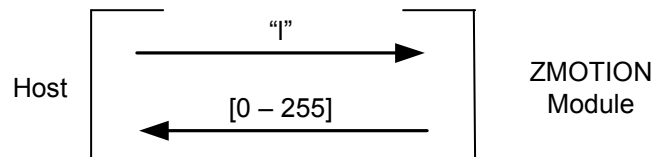

Write Light Gate Threshold

Command

'L' (0x4C)

Description

The 'L' command sets the Light Gate Threshold value.

Input Values

0-255 (decimal)

Normal Command Sequence

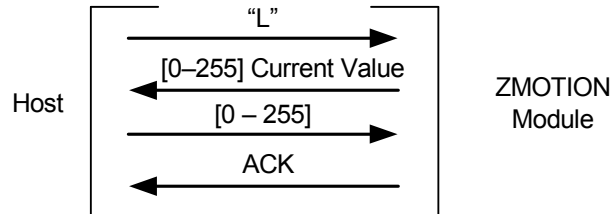

MD/RST Pin Configuration

The $\overline{\text{MD/RST}}$ pin can be configured to function as either the Motion Detect output or the Reset input. This command selects between the two modes. As $\overline{\text{RST}}$, a Low on this pin causes the Module to perform a full hardware reset. See the [Signal Descriptions, Serial Interface Mode](#) section on page 6 for more information.

Read $\overline{\text{MD/RST}}$ Pin Configuration

Command

'c' (0x63)

Description

This Read command returns the configuration mode of the $\overline{\text{MD/RST}}$ pin as set by the 'C' command.

Return Values

'M' = $\overline{\text{MD/RST}}$ pin configured as $\overline{\text{MD}}$

'R' = $\overline{\text{MD/RST}}$ pin configured as $\overline{\text{RST}}$

Normal Command Sequence

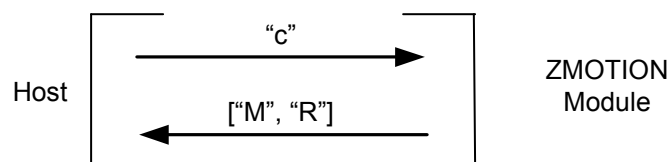

Write $\overline{\text{MD/RST}}$ Pin Configuration

Command

'C' (0x43)

Description

Configures the $\overline{\text{MD/RST}}$ pin as either Motion Detect output ($\overline{\text{MD}}$) or Module Reset ($\overline{\text{RST}}$).

Input Values

'M' = Configure $\overline{MD}/\overline{RST}$ pin as \overline{MD}

'R' = Configure $\overline{MD}/\overline{RST}$ pin as \overline{RST}

Normal Command Sequence

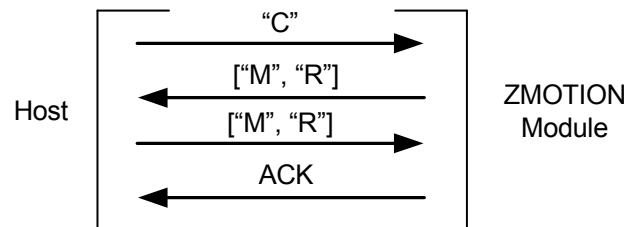

MD Activation Time

The duration in which the $\overline{\text{MD}}$ pin is held active when motion is detected is configured by this command. See Table 5 for corresponding values.

Table 5. $\overline{\text{MD}}$ Output Activation Time Values

Command Value	$\overline{\text{MD}}$ Output Activation Time
0	Output does not activate upon motion.
1–127	1–127 seconds.
128	Output does not activate upon motion.
129–255	1–128 minutes.

Read MD Activation Time

Command

`'d'` (0x64)

Description

Returns the $\overline{\text{MD}}$ pin output activation time value used when motion is detected.

Return Values

0–255 (decimal); see Table 5.

Normal Command Sequence

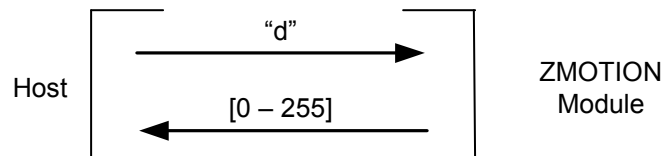

Write MD Activation Time

Command

`'D'` (0x44)

Description

Selects the $\overline{\text{MD}}$ pin output activation time value used when motion is detected.

Input Values

0–255 (decimal); see Table 5.

Normal Command Sequence

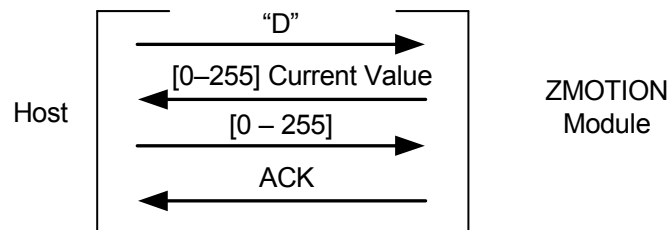

Hyper Sense

Hyper Sense Mode allows smaller signal changes to be considered valid motion events. This mode significantly increases sensitivity at the cost of more potential false motion detections. The typical application for this mode is in occupancy sensing where it is enabled after valid 'normal' motion has already been detected.

Read Hyper Sense Setting

Command

'e' (0x65)

Description

This command returns the current status of the Hyper Sense setting.

Return Values

'Y' = Hyper Sense Enabled

'N' = Hyper Sense Disabled

Normal Command Sequence

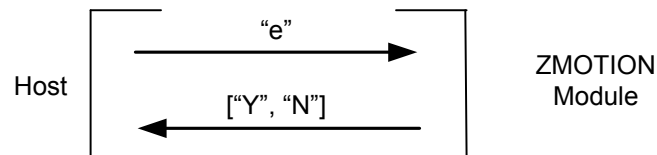

Write Hyper Sense Setting

Command

'E' (0x45)

Description

This command enables and disables Hyper Sense Mode.

Input Values

'Y' = Hyper Sense Enabled

'N' = Hyper Sense Disabled

Normal Command Sequence

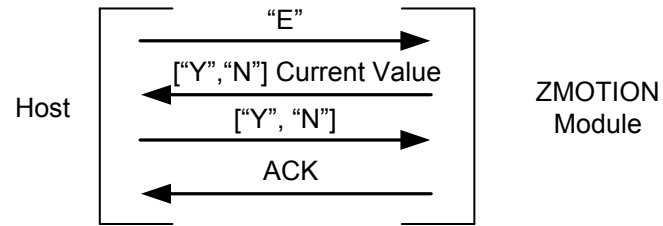

Hyper Sense Level Setting

This command defines the Hyper Sense sensitivity level when the mode is enabled via the 'E' command. The purpose of the Hyper Sense Mode is to increase the detectors sensitivity to more subtle motion events. A value of 0 to 3 is used to set the level. Setting the level to 0 has the same effect as disabling Hyper Sense with the 'E' command (setting it to 'N'). Setting it to any other level can cause the occasional false detection, so this mode should only be used when the occasional false detection is tolerable.

Read Hyper Sense Level Setting

Command

'g' (0x67)

Description

This command returns the current Hyper Sense level that will be used when the Hyper Sense Mode is enabled via the 'E' command. 0 is the lowest setting and corresponds to off, while 3 is the most sensitive setting.

Return Values

0-3 (decimal)

Normal Command Sequence

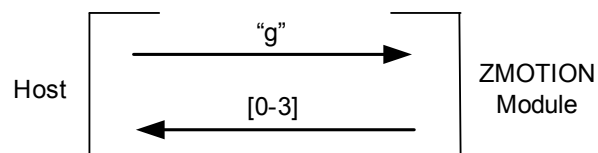

Write Hyper Sense Level Setting

Command

'G' (0x47)

Description

This command sets the Hyper Sense level used when it is enabled via the 'E' command. If Hyper Sense is currently on ('E' set to 'Y') when a new level is written, the new level is automatically used.

Input Values

0-3 (decimal)

Normal Command Sequence

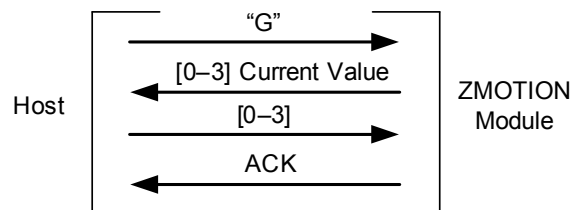

Frequency Response Setting

The Frequency Response setting controls sensitivity to targets producing lower frequencies. When set to 'H', sensitivity to targets producing lower frequencies is reduced. This reduced sensitivity also has the effect of reducing the distance over which the ZMOTION® Detection Module II can detect motion.

Read Frequency Response Setting

Command

'f' (0x66)

Description

This command returns the current frequency response setting of the Module.

Return Values

L = low and high frequency targets detected

H = low frequency target sensitivity reduced

Normal Command Sequence

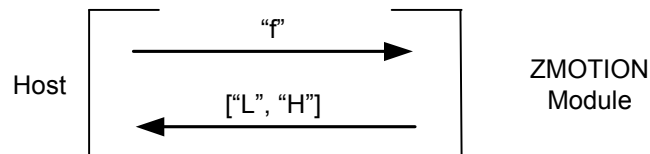

Write Frequency Response Setting

Command

'F' (0x46)

Description

This command sets the Frequency Response of the Module.

Input Values

L = low and high frequency targets detected

H = low frequency target sensitivity reduced

Normal Command Sequence

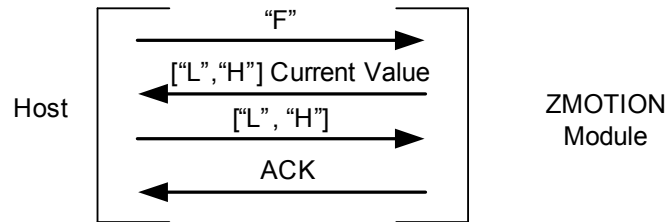

Motion Detection Suspend

This command enables and disables motion detection by the ZMOTION® Detection Module II. When set to ‘N’, the Module detects motion. When set to ‘Y’, motion detection is suspended. While Motion Detection Suspend is a method to temporarily disable motion detection, the \overline{MD} pin may still be *manually* driven active/inactive via the ‘O’ (Write \overline{MD} Output State) command.

Read Motion Detection Suspend Setting

Command

‘h’ (0x68)

Description

This read command returns the current Motion Detection Suspend setting.

Return Values

Y = Motion Detection is suspended

N = Motion Detection is active

Normal Command Sequence

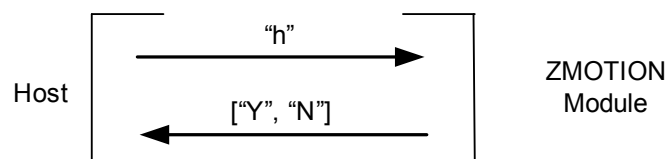

Write Motion Detection Suspend Setting

Command

‘H’ (0x48)

Description

This write command enables and disables motion detection by ZDMII.

Input Values

Y = Motion detection is suspended

N = Motion detection is active

Normal Command Sequence

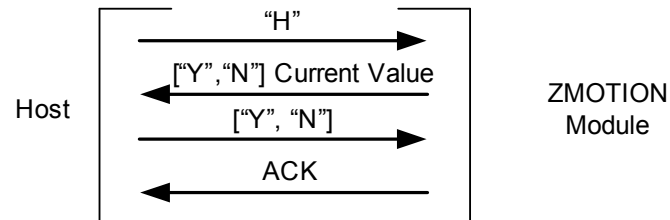

Software Revision

The software in the ZMOTION® Detection Module II is made up of two parts:

- ZMOTION® Engine with advanced passive infrared software
- Application software

Both the ZMOTION Engine and the application software have been preloaded into the ZDMII during production. The Software Revision command returns the revisions of this software.

The ZMOTION Engine is locked into the device and cannot be changed. This software provides all of the algorithms and processing functions required for motion detection. Refer to the [ZMOTION Detection and Control Product Specification \(PS0285\)](#) for more details about the operation of this software.

For all of its motion detection functions, the ZMOTION® Detection Module II application software provides the serial and hardware interface mode functionality of – and uses the services provided by – the advanced passive infrared software engine. This ZDMII application software can be modified for custom applications.

See [Appendix D. Software Revisions](#) on page 65 for version information details.

Software Revision

Command

`'i' (0x69)`

Description

The 'i' command returns the revision of the software programmed into the ZMOTION® Detection Module II. The first value returned is the application software revision. The second value returned is the advanced passive infrared software engine revision. See [Tables 14 and 15](#) in Appendix C for a description of these software revisions.

Return Values

VAL1 = 0–255 (decimal); Application Software Version

VAL2 = 0–255 (decimal); ZMOTION Software Engine Version

Normal Command Sequence

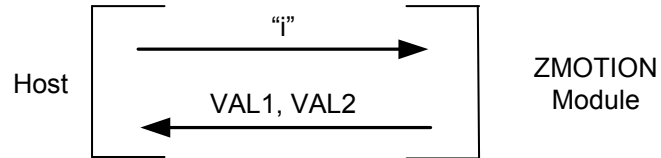

Serial Interface Command Mode

The serial interface can operate in either ASCII or ASCII/Decimal modes. The default is ASCII/Decimal where commands are sent as ASCII characters, but numeric values sent and returned are decimal. In ASCII Mode, all commands and numeric values are sent and returned in ASCII, which is useful for demonstration purposes or when using a terminal to control and monitor ZDMII (see [Table 6](#) on page 35).

For example, the data for the Sensitivity command is a value from 0 to 255. In ASCII/Decimal Mode, this data would be sent as a single byte (0x00 to 0xFF). In ASCII Mode, this data would be sent as 3 bytes: '0','0','0' to '2','5','5'. All values are sent as 3 characters.

Table 6. MD Output Activation Time Values

Command Value	MD Output Activation Time
0	Output does not activate upon motion.
1–127	1–127 seconds.
128	Output does not activate upon motion.
129–255	1–128 minutes.

Read Serial Interface Command Mode

Command

'k' (0x6B)

Description

This command returns the current command interface mode.

Return Values

'A' = ASCII Mode enabled

'D' = ASCII/Decimal Mode enabled (default)

Normal Command Sequence

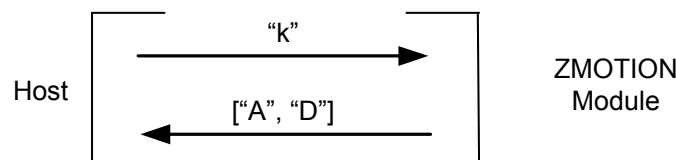

Write Serial Interface Command Mode

Command

"K" (0x4B)

Description

This command selects the command interface mode.

Input Values

'A' = ASCII Mode enabled

'D' = ASCII/Decimal Mode enabled

Normal Command Sequence

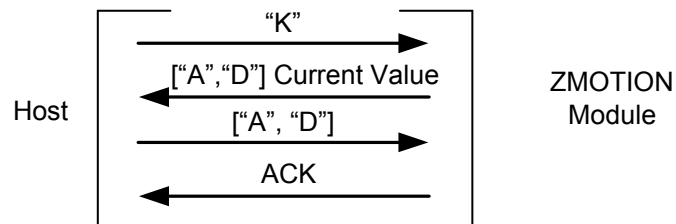

s

Motion Detected Unsolicited Mode

This mode allows the ZMOTION® Detection Module II to send motion detection status to the Host unsolicited (without first sending the 'a' command). The Module will send an 'M' to the Host every time motion is detected. When Unsolicited Mode is not used, the Host must poll the Module using the 'a' command or read the Current Output Active Time using the 'o' to determine motion detection status.

Read Motion Detected Unsolicited Mode

Command

'm' (0x6D)

Description

This read command returns the Motion Detected Unsolicited Mode currently selected.

Return Values

'Y' = Unsolicited Mode is enabled; the Module sends an 'M' each time motion is detected.

'N' = Unsolicited Mode is disabled.

Normal Command Sequence

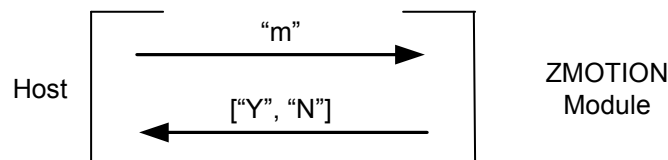

Write Motion Detected Unsolicited Mode

Command

'M' (0x4D)

Description

Enable/disable Motion Detected Unsolicited Mode.

Input Values

'Y' = Unsolicited Mode is enabled; the Module sends an 'M' each time motion is detected.

'N' = Unsolicited Mode is disabled.

Normal Command Sequence

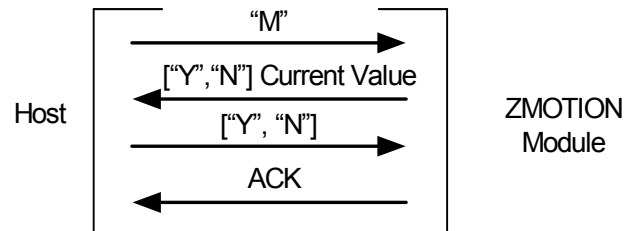

\overline{MD} Current Active Output Time

This command directly controls the \overline{MD} output pin. The ‘O’ command activates the \overline{MD} output pin for the amount of time specified in the command; it is a manual override of the current state of \overline{MD} and is independent of motion detection. The valid range is listed in Table 7. The ‘o’ command is used to read the remaining time in which \overline{MD} will be held active—as initiated by this command or by detected motion. If motion is detected after the ‘O’ command is given, the \overline{MD} output time restarts at the \overline{MD} Activation Time set by the ‘D’ command.

Table 7. \overline{MD} Output Activation Time Values

Command Value	\overline{MD} Output Activation Time
0	Output does not activate upon motion.
1–127	1–127 seconds.
128	Output does not activate upon motion.
129–255	1–128 minutes.

Read \overline{MD} Current Output Active Time

Command

‘o’ (0x6F)

Description

Returns the remaining time in which the \overline{MD} output pin will be held active.

Return Values

0–255 (decimal); see Table 7.

Normal Command Sequence

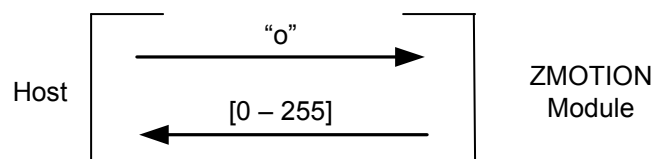

- **Note:** This command is still valid if the \overline{MD} pin is configured for \overline{RST} . The command returns the state of \overline{MD} pin as if it was configured to indicate motion.

Write \overline{MD} Output State

Command

'O' (0x4F)

Description

Activates the \overline{MD} output pin for the duration of activation time required.

Input Values

0–255 (decimal); \overline{MD} activated for a selected duration of time; see [Table 7](#) on page 39.

Normal Command Sequence

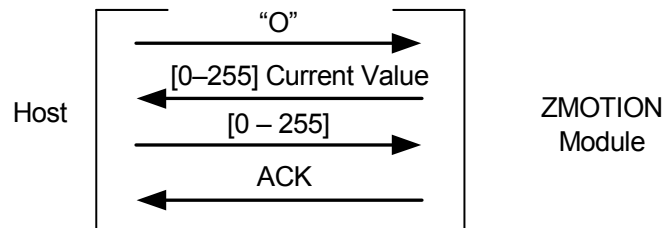

- **Note:** This command does not affect the Read Motion Status command ('a') or the Clear Motion Status command ('A').

If the \overline{MD} pin is configured as Reset, the value is saved as if the \overline{MD} pin is configured to indicate motion.

Ping

This command provides a simple method to ping ZDMII to ensure it is responding to commands. The 'P' command writes a value (typically a 1 or a 2) that can be read back using the 'p' command. The 'P' command only accepts a single written character whether it is in ASCII Mode or ASCII/Decimal Mode ('K' command). For example, sending the command 'P', '1' will return '0', '4', '9' in ASCII Mode and 0x31 (49 decimal) in ASCII/Decimal Mode.

Read Ping Value

Command

'p' (0x70)

Description

This command returns the last written Ping value.

Return Values

Last value written using the 'P' command. The default value is 1.

Normal Command Sequence

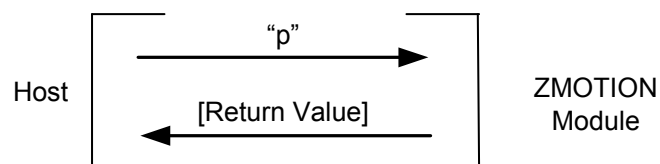

Write Ping Value

Command

'P' (0x50)

Description

This write command stores a value that can be read by the 'p' command.

Input Values

0–255 (decimal); a value is stored and read by the 'p' command.

Normal Command Sequence

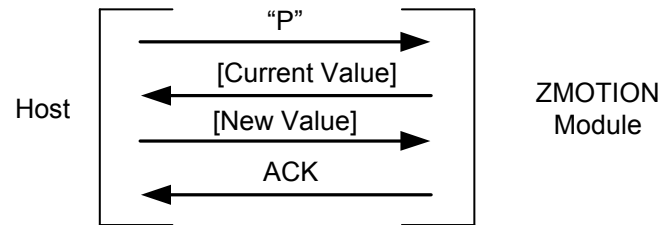

Range Setting

This command determines the relative range of motion detection. Larger values decrease the range of detection. Range is also dependent on target size, speed and relative temperature. For example, a range control setting that rejects one target of a particular size at a given distance does not guarantee that a larger target will be rejected at the same distance.

Read Range Setting

Command

`'r'` (0x72)

Description

This command returns the current range setting.

Return Values

0–7 (decimal)

Normal Command Sequence

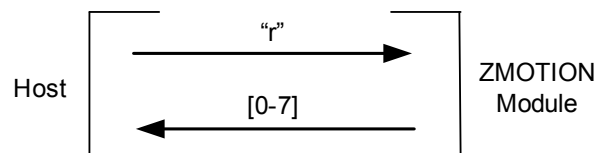

Write Range Setting

Command

`'R'` (0x52)

Description

This command sets the Range value.

Input Values

0–7 (decimal)

Normal Command Sequence

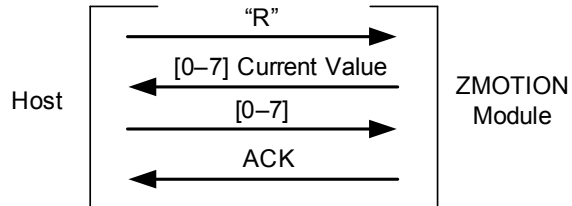

Sensitivity

This command controls how sensitive ZDMII is to motion. Larger values provide lower sensitivity and also have the effect of reducing the range. Smaller values provide higher sensitivity.

Read Sensitivity

Command

's' (0x73)

Description

This command returns the current motion detection sensitivity setting.

Return Values

0–255 (decimal)

Normal Command Sequence

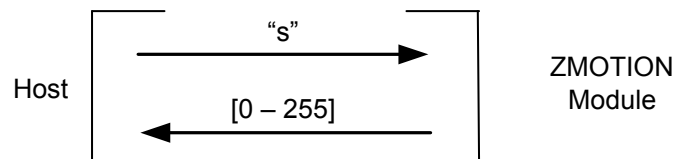

Write Sensitivity

Command

'S' (0x53)

Description

This command sets the motion detection sensitivity.

Input Values

0–255 (decimal)

Normal Command Sequence

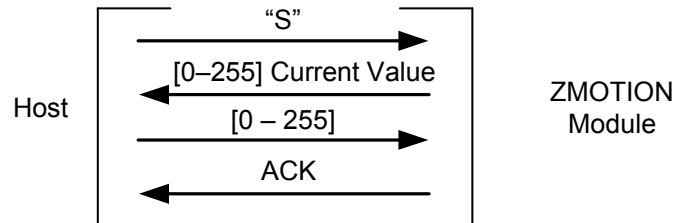

Directional Detection

Directional Detection places ZDMII in a mode that detects both positive and negative motion directions. When Dual Direction Mode is enabled via the 'U' command, motion is detected in either direction and the 'a' and 'M' commands are enhanced to respond with a '+' or '-' to indicate the direction of the motion target. Single Direction Mode is enabled via the 'V' command and is similar to the 'U' command except motion is detected in only one of the '+' or '-' directions as set when the 'V' command is issued. The 'a' and 'M' commands are not modified when in Single Direction Mode.

The signal generated by the pyroelectric sensor used to discern direction can vary from device to device, but is consistent for a particular device. Therefore, the '+' and '-' direction settings can mean either left to right or right to left motion, but will always be the same for that particular device. Each device can be calibrated simply by creating motion in one or both directions and observing the results. Other factors such as where the target starts motion will affect the directional detection capabilities of ZDMII. Directional detection works best when the target moves horizontally starting from outside of the range (left or right side) of Module and through the beams of the detection pattern. If the target begins motion while inside the Module detection pattern area, an incorrect direction can be reported.

Table 8 lists the pages in this section that describe their respective commands.

Table 8. Shortcuts to Directional Detection Commands

Name	Command	Page
Read Dual Direction Mode	'u' (0x75)	47
Write Dual Direction Mode	'U' (0x55)	48
Read Single Direction Mode	'v' (0x76)	49
Write Single Direction Mode	'V' (0x56)	49

Read Dual Direction Mode

Command

'u' (0x75)

Description

The 'u' command returns the current Dual Direction Mode setting.

Return Values

'N' = Dual Direction Mode disabled.

'Y' = Dual Direction Mode enabled.

Normal Command Sequence

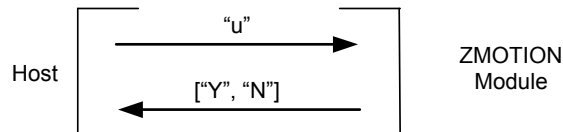

Write Dual Direction Mode

Command

'U' (0x55)

Description

Enable directional detection in both '+' and '-' directions.

When Dual Direction Mode is enabled, the 'a' command ([Read Motion Status](#)) and the 'M' command ([Motion Detected Unsolicited Mode](#)) provide the following directional information:

'+' = Motion detected in the '+' direction

'-' = Motion detected in the '-' direction

Input Values

'N' = Dual Direction Mode disabled

'Y' = Dual Direction Mode enabled

Normal Command Sequence

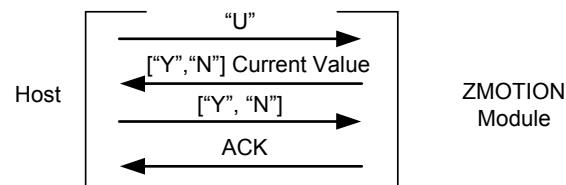

Read Single Direction Mode

Command

'v' (0x76)

Description

The 'v' command returns the current setting of the Single Direction Mode.

Return Values

'A' = Single Direction Mode disabled.

'+' = Single Direction Mode set to detect motion only in the '+' direction.

'-' = Single Direction Mode set to detect motion only in the '-' direction.

Normal Command Sequence

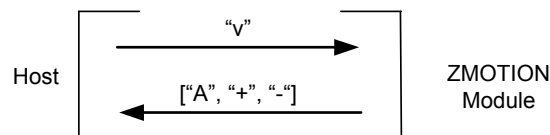

Write Single Direction Mode

Command

'V' (0x56)

Description

The 'V' command selects the direction of motion to be detected. When Single Direction Mode is enabled, motion status is reported only when motion is detected in the direction specified. For example, if the '+' direction is specified, then the 'a' command (Read Motion Status) will return a 'Y' only when motion is detected in the '+' direction. If motion is detected in the '-' direction, the 'a' command would return 'N'.

Input Values

'A' = Single Direction Mode disabled.

'+' = Detect motion only in the '+' direction.

'-' = Detect motion only in the '-' direction.

Normal Command Sequence

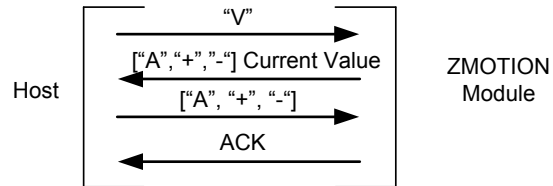

Module Reset

This command forces ZDMII to perform a reset. All configuration and status are returned to default values; see [Table 3](#) on page 15.

This is a special command that requires confirmation. After 'X' is received, the Module sends an ACK and expects the 4-digit confirmation sequence (1, 2, 3, 4).

Once this sequence is received the device sends an 'ACK' and performs a reset. If the confirmation sequence is incorrect or the inactivity time-out is exceeded, the device will send a 'NACK' and ignore the reset request.

Table 9 lists the pages in this section that describe their respective commands.

Table 9. Shortcuts to Module Reset Commands

Name	Command	Page
Module Reset	'X' (0x58)	51
Read Sleep Time	'y' (0x79)	52
Write Sleep Time	'Y' (0x79)	52

Module Reset

Command

'X' (0x58)

Description

Reset the ZMOTION® Detection Module II.

Return Values

ACK = Reset command accepted.

NACK = Reset command not accepted.

Normal Command Sequence

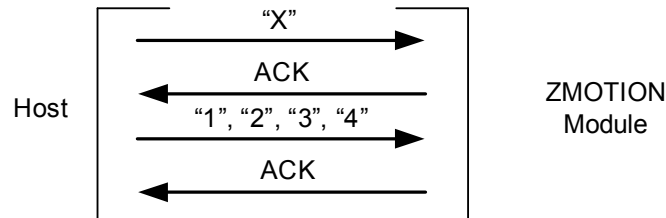

Read Sleep Time

Command

'y' (0x79)

Description

This command returns the current sleep time setting in seconds.

Return Values

0–255 (decimal)

Normal Command Sequence

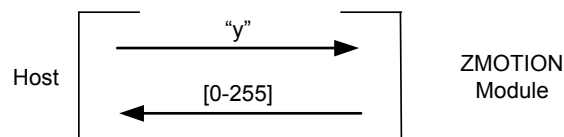

Write Sleep Time

Command

'Y' (0x79)

Description

This command sets the Sleep duration in seconds. A value of 0 disables the sleep timer, and wake-up is initiated only by a transition on the $\overline{\text{SLP}}$ pin or when a character is received over the serial interface (i.e., the character is received and processed).

Input Values

0–255 (decimal)

Normal Command Sequence

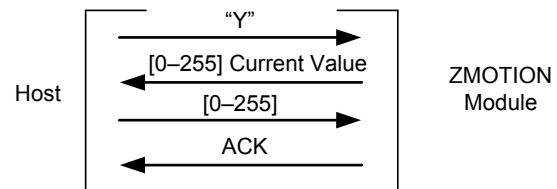

Sleep Mode

This command places ZDMII into Sleep Mode. Sleep Mode Enable is a special command that requires confirmation. After the 'Z' is received, the Module sends an ACK and expects the 4-digit confirmation sequence (1, 2, 3, 4). After this sequence is received, the device sends an ACK and enters low-power Sleep Mode for the number of seconds set by the 'Y' (Write Sleep Time) command. If the confirm sequence is incorrect or the inactivity time-out is exceeded, the device will send a NACK and ignore the reset request.

Sleep Mode is exited automatically when the sleep time expires or by a transition on the SLP pin or by sending a character over the serial interface—this character is ignored. A value of 0 for sleep time disables the sleep timer.

Sleep Mode Enable

Command

'Z' (0x5A)

Description

The 'Z' command places the ZMOTION® Detection Module II into low-power Sleep Mode.

Return Values

ACK = Sleep command accepted.

NACK = Sleep command not accepted.

Normal Command Sequence

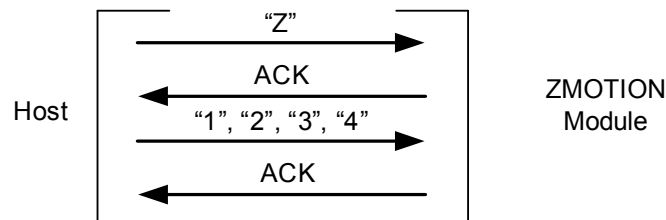

Detection Pattern

The Fresnel lens directs the infrared energy from the target on to the pyroelectric sensor. Figure 8 shows the coverage area provided by the ZMOTION® Detection Module II. It provides a 95-degree cone with three beams; the inner beams provide greater range than the outer beams. The actual range is affected by ambient temperature and the settings provided to the Module; Sensitivity, Range, Hyper Sense and Frequency Response all contribute to the range performance.

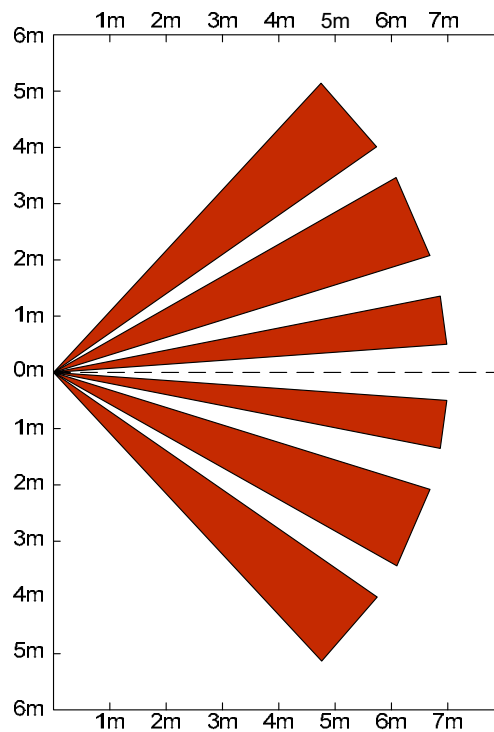

Figure 8. Detection Pattern

Mechanical Information

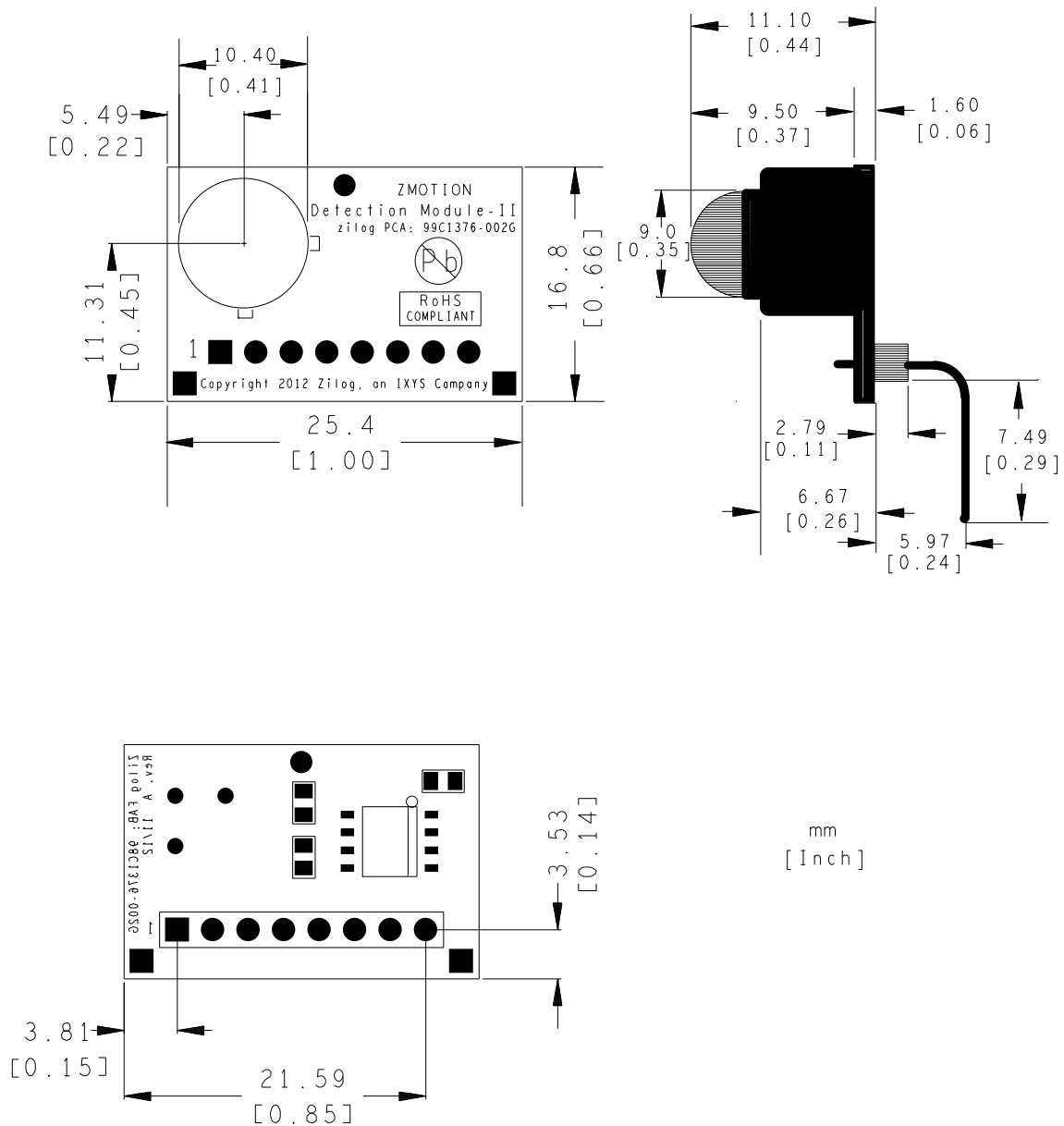

Figure 9. Mechanical Drawing of the ZMOTION Detection Module II
(Right-Angled Pins, ZEPiR0BAS02MODG)

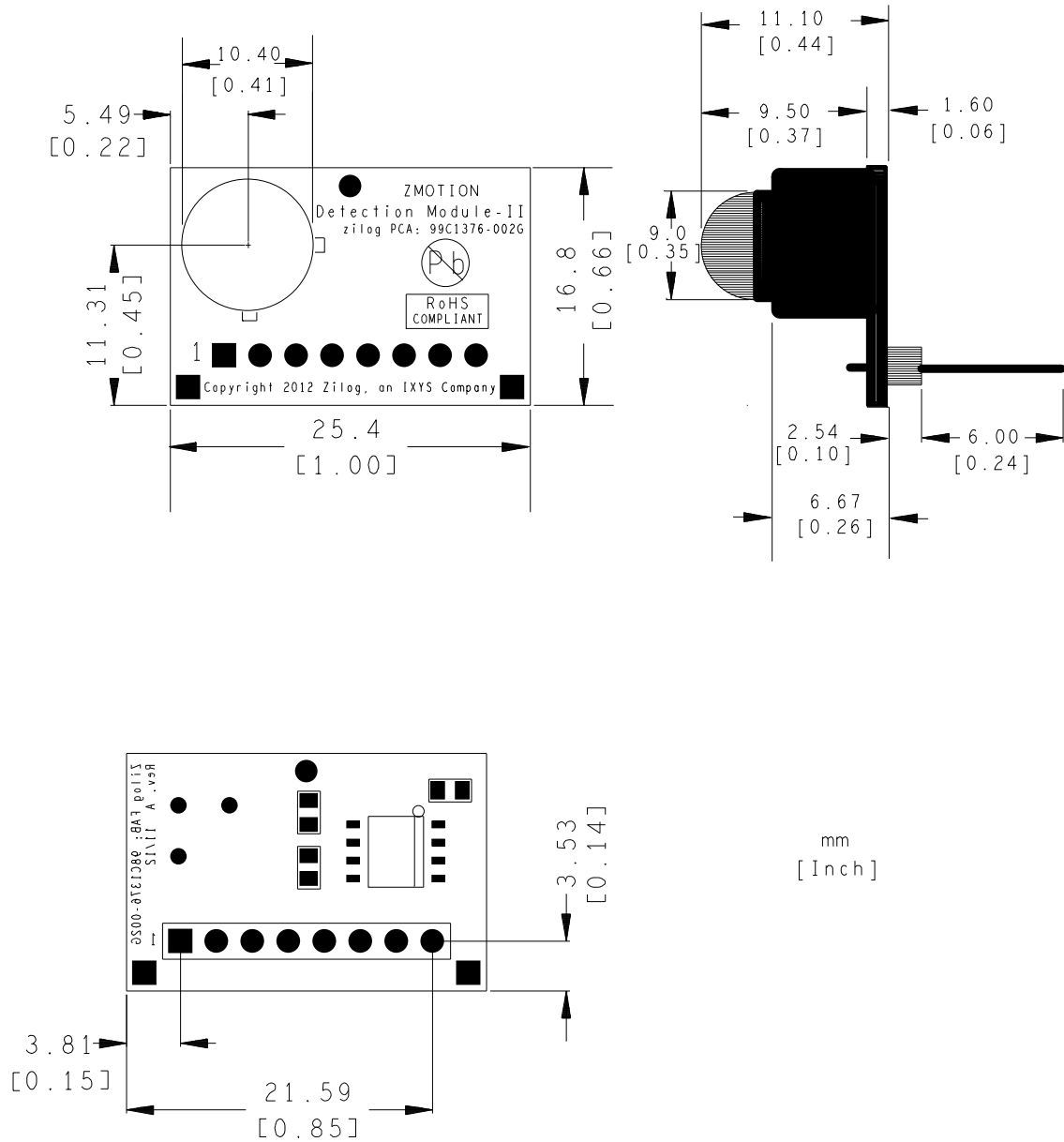

Figure 10. Mechanical Drawing of the ZMOTION Detection Module II (Straight Pins, ZEPIR0BBS02MODG)

Related Documentation

The documents associated with ZDMII are listed in Table 10. Each of these documents can be obtained from the Zilog website by clicking the link associated with its Document Number.

Table 10. ZMOTION Detection Module II Reference Design Documentation

Document ID	Document Title
PB0244	ZMOTION Detection Module II Product Brief
PS0305	This ZMOTION Detection Module II Product Specification
UM0260	ZMOTION Detection Module II Evaluation Kit User Manual
RD0026	ZMOTION Detection Module II Reference Design
RD0026-SC01	Source code for the ZMOTION Detection Module II Reference Design
PS0285	Z8FS021 ZMOTION Detection and Control Product Specification
PS0228	Z8 Encore! XP F082A Series Product Specification
PS0286	ZMOTION Lens Product Specification
PS0336	ZMOTION Pyroelectric Sensor Product Specification
WP0017	ZMOTION - A New PIR Motion Detection Architecture
WP0018	ZMOTION Detection Lens and Pyro Sensor Configuration Guide
WP0018-SC01	Application Library for the ZMOTION Detection Lens and Pyro Sensor Configuration Guide

Related Products

The table below lists the products related to the ZMOTION® Detection Module II.

Product Number	Product Description
Z8FS040BSB20EG	ZMOTION MCU (8-pin SOIC)*
Z8FS040BHH20EG	ZMOTION MCU (20-pin SOIC)*
Z8FS040BHJ20EG	ZMOTION MCU (28-pin SOIC)*
ZEPIR000103KITG	ZMOTION Detection Module II Evaluation Kit
ZEPIR000103ZRDG	ZMOTION Detection Module II Reference Design

Note: *These products are described in Zilog's [ZMOTION Detection and Control Product Specification \(PS0285\)](#).

Electrical Characteristics

The data in Table 11 were captured during prequalification and precharacterization testing and are subject to change. For additional electrical characteristics, refer to the [F082A Series Product Specification \(PS0228\)](#).

Table 11. Electrical Characteristics

Symbol	Parameter	Min	Typ	Max	Units	Conditions
V _{POR}	Power-on Reset Voltage Threshold	2.20	2.45	2.70	V	V _{DD} = V _{POR}
V _{VBO}	Voltage Brown-Out Reset Voltage Threshold	2.15	2.40	2.65	V	V _{DD} = V _{POR}
T _{RAMP}	Time for V _{DD} to transition from V _{SS} to V _{POR} to ensure valid Reset	0.10	—	100	ms	—
T _{POR}	Power-On Reset Digital Delay	—	1.0	—	ms	—
V _{DD}	Supply Voltage	2.8	—	3.6	V	—
V _{IL1}	Low Level Input Voltage	-0.3	—	0.3*V _{DD}	V	RXD, /RST, SLP
V _{IH1}	High Level Input Voltage	0.7*V _{DD}	—	5.5	V	RXD, /RST, SLP
V _{OL1}	Low Level Output Voltage	—	—	0.4	V	I _{OL} = 2 mA; V _{DD} = 3.0V TXD, MD
V _{OL2}	Low Level Output Voltage	—	—	0.6	V	I _{OL} = 20 mA; V _{DD} = 3.3V TXD, MD
V _{OH1}	High Level Output Voltage	2.4	—	—	V	I _{OH} = -2 mA; V _{DD} = 3.0V TXD, MD
V _{OH2}	High Level Output Voltage	2.4	—	—	V	I _{OH} = -20 mA; V _{DD} = 3.3V TXD, MD
I _{DD} Active	Supply Current in Active Mode	—	8.9mA	—	—	V _{DD} = 3.3V
I _{DD} Sleep	Supply Current in Sleep Mode	—	450µA (Typ)	—	—	V _{DD} = 3.3V
T _{PIR}	PIR Stabilization Time	—	20	—	seconds	—
Z _{IN}	Analog Pin Input Impedance	—	550	—	KΩ	DLY, SNS, LG
	Serial Interface Inactivity Time-out	—	2.5	—	seconds	—

Absolute Maximum Ratings

Stresses greater than those listed in Table 12 can cause permanent damage to the device. These ratings are stress ratings only. Operation of the device at any condition outside those indicated in the operational sections of these specifications is not implied. Exposure to absolute maximum rating conditions for extended periods may affect device reliability.

Table 12. Absolute Maximum Ratings

Parameter	Min	Max	Units
Ambient Temperature Under Bias	0	70	°C
Storage Temperature	-65	+150	°C
Voltage on Any Pin with respect to V_{SS}	-0.3	+5.5	V
Voltage on V_{DD} Pin with respect to V_{SS}	-0.3	+3.6	V
Maximum Output Current from Active Output Pin	-25	+25	mA

Ordering Information

You can order ZDMII from Zilog or any of Zilog’s authorized distributors using the following part numbers. For more information about ordering, please consult your local Zilog sales office. The [Zilog website](#) lists all regional offices and provides additional information about the ZMOTION® Detection Module II product line.

Part Numbers

Table 13 lists the part numbers for the ZDMII products and kit, and briefly describes each part.

Table 13. Part Numbers

Part Number	Description
ZEPIR0BAS02MODG	ZMOTION Detection Module II (right-angle connector)
ZEPIR0BBS02MODG	ZMOTION Detection Module II (straight connector)
ZEPIR000103KITG	ZMOTION Detection Module II Evaluation Kit

Appendix A. Schematic Diagram

Figure 11 presents a schematic representation of the ZMOTION® Detection Module II.

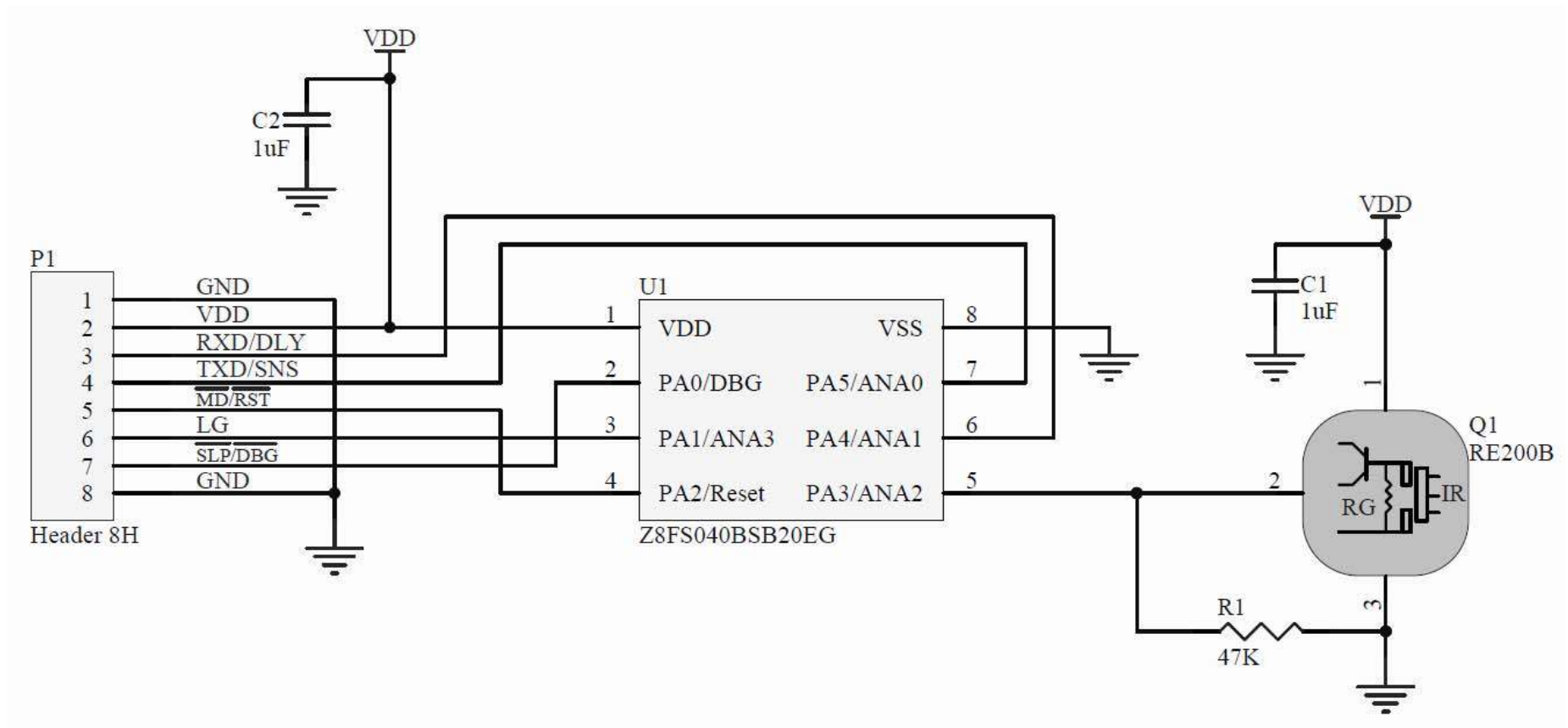

Figure 11. Schematic Diagram of ZMOTION Detection Module II

Appendix B. Hardware Interface Mode

The schematic in Figure 12 shows a typical application example of how to use the Module in Hardware Interface Mode.

Hardware Interface Mode is selected because the Sense pin is between 0V and 1.8V. In this example, the DLY and SNS signals are connected to trim pots for control of the \overline{MD} output activation time and the motion detection sensitivity, respectively. These connections can also be replaced with fixed resistor values in an application where adjustments are not necessary. The Sleep feature is not being used so the \overline{SLP} input is left unconnected as there is an internal pull-up resistor to ensure this pin remains inactive. It is also acceptable to tie this pin to V_{DD} . The \overline{MD} signal directly drives a solid state relay and is active low. The Light Gate (LG) signal is connected to a CDS photocell in a divider configuration with a potentiometer to adjust the light level. The signal is used by the Module to gate the \overline{MD} signal such that it does not activate in the presence of daytime ambient light. When the voltage on this pin is lower than 1.0V, the \overline{MD} signal will not activate even when motion is detected.

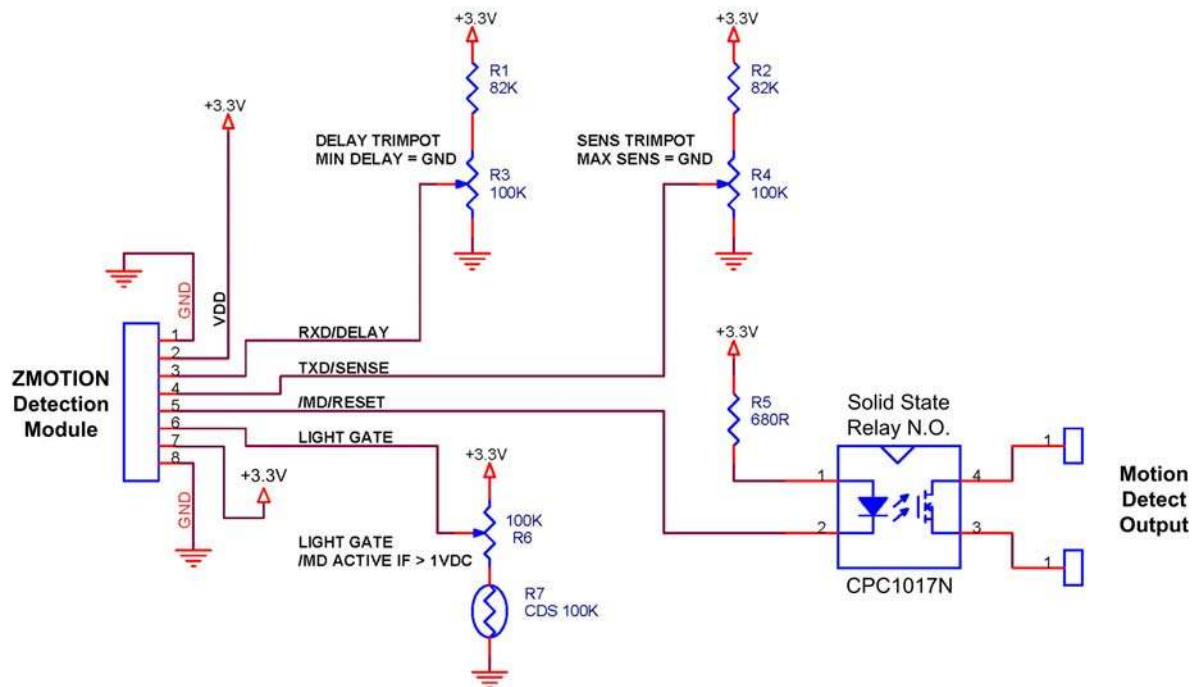

Figure 12. Application Example, Hardware Interface Mode

Appendix C. Serial Interface Mode

The schematic in Figure 13 shows a typical application example of how to use the module in Serial Interface Mode.

Serial Interface Mode is selected because the TXD pin is pulled High via the 10KΩ resistor R1. This High state is only required to be guaranteed during power up. In this example, the RXD and TXD signals are connected to the TXD and RXD signals (respectively) of the Z8F1680. Since the \overline{MD} and \overline{SLP} signals are still active in the Serial Interface Mode, they are also connected to the host MCU. If they were not connected to the MCU, \overline{MD} would typically drive the control circuitry similar the Hardware Interface Mode and \overline{SLP} either left unconnected or tied high. \overline{SLP} has an internal pull-up to ensure proper operation. The Light Gate (LG) signal is connected to a CDS photocell in a divider configuration with a potentiometer to adjust the light level. The signal is used by the Module to gate the \overline{MD} signal such that it does not activate in the presence of daytime ambient light. When the signal on this pin is lower than the value programmed into the Light Gate Threshold register, the \overline{MD} signal will not activate even when motion is detected.

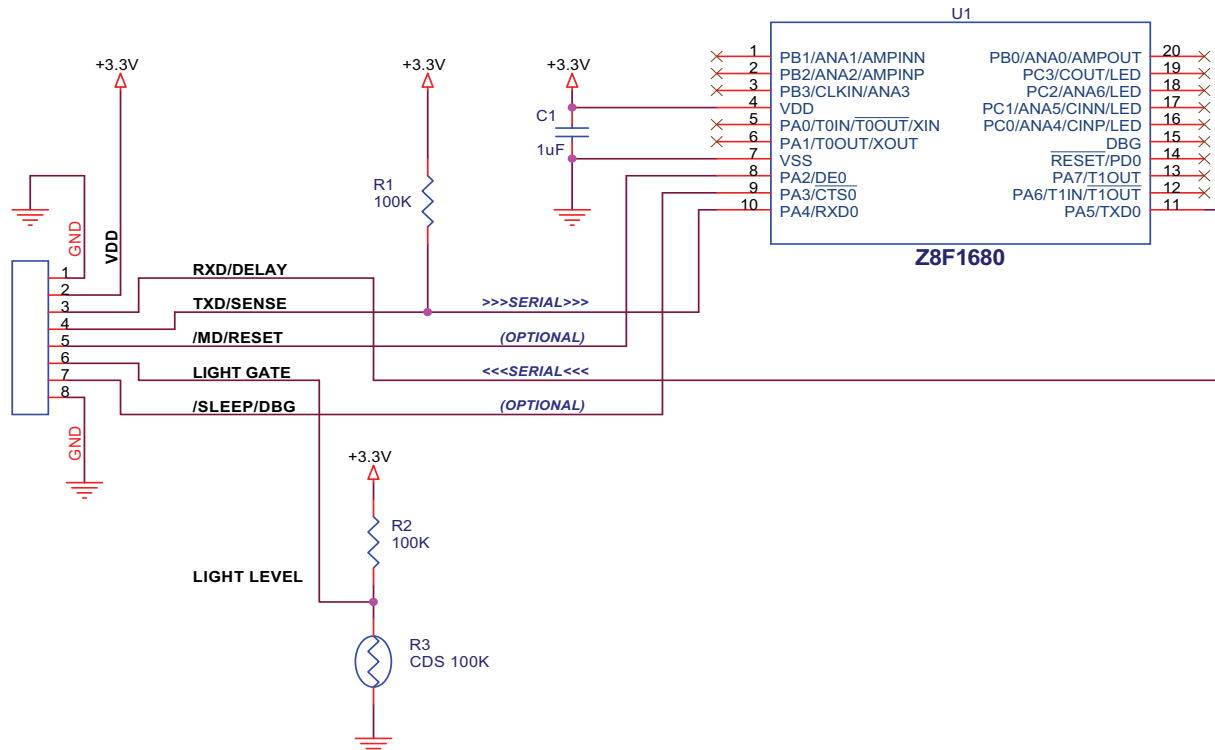

Figure 13. Application Example, Serial Interface Mode

Appendix D. Software Revisions

Tables 14 and 15 identify the application software and ZMOTION Engine revisions made to ZDMII since its inception.

Table 14. ZMOTION Detection Module II Application Software Revision

Returned Value ('i' command)	Software Revision	Changes/Updates
1	1.0	Initial production release.
2	2.0	Support for additional features in ZDMII. Added ASCII Serial Mode, RAM R/W, and sleep timer. Improved Sleep Mode current.
4	2.0	Support for additional ZDMII features. Added ASCII Serial Mode and sleep timer. Improved Sleep Mode current.
6	3.0	API settings changes to provide better performance with supported lenses. Fixed issue with 'L' command. Added 'G' and 'g' commands. Fixed range value issue. Fixed issue with LG input when delay is 3 minutes or greater. Added command for Hyper Sense level.
6	3.01	ZMOTION API changes to support new lenses for ZDMII. No changes to functionality since ZDM v3.0.

Table 15. ZMOTION Engine Revision

Returned Value ('i' command)	Software Revision	Changes/Updates
1	1.0	Initial production release.
4	2.0	Release of the ZMOTION MCU. Improved detection/stability. Added Range, Low Power, Hyper Sense, advanced API features.

Index

Numerics

95-degree detection pattern 1

A

Absolute Maximum Ratings 60
ambient light 6, 7, 10, 18, 63, 64
 hardware interface mode 10, 63
 Light Gate 6, 7
 Light Gate Level commands 18
 serial interface mode 64
ambient light input 3
ambient light sensing 1
Ambient Light Sensor 1
applications 1, 11, 12, 33
 custom 33
applications, custom 33
Architectural Overview 1

C

Commands, Serial 15
Confirmed Command Structure 13
Customer Support 70

D

DBG 3
Delay – also see DLY 3, 5, 8, 59, 65
 pin 10
 time 5
Detection Pattern 55
Directional Detection 47
DLY 3, 5, 7, 8, 10, 59, 63
 signal 6, 7

E

Electrical Characteristics 59
evaluation
 ZDM II 1
Evaluation Kit 58, 61
evaluation kit

user manual 58

F

false motion detection 25
Features 1
Frequency Response Setting 29

G

Ground 4, 6

H

Hardware Interface Mode 10, 11
hardware interface mode
 data transmission 7
 operation 10
 selection 4
 sensitivity 5
 signal descriptions 4
 sleep mode 11
 software revision 33
Hardware Interface modes 4
Hardware Mode 1
hardware reset 21
 signal 7
Hyper Sense 1, 25, 55, 65
hyper sense
 level setting 27
 setting 15

I

Index 66

L

lens 1, 55, 58
LG 3, 4, 6, 7, 8, 10, 11, 18, 59, 63, 64
 input 65
Light Gate – also see LG 3, 6, 7, 11
 analog input 3
 input level 16, 18

- level commands 18
- pin 18
- signal 10, 63, 64
- threshold 18
- Threshold Read 15, 19
- Threshold Register 8
- threshold value 18
- Threshold Write 15, 19

List of Figures vii
List of Tables viii

M

- MD 3, 15, 21, 22, 59
 - activation time 23
 - current active output time 39
- MD/RST pin configuration 21
- Mechanical Information 56
- Module Reset 51
- Motion Detect – also see MD 6
 - and Reset 7
- motion detection 43
 - enable/disable 31
 - false 25
 - functions 33
 - output 1, 39
 - performance 1
 - range 43
 - requirements 11, 12, 33
 - sensitivity 45, 63
 - sensitivity level 10
 - status 37
 - suspend settings 15
 - suspension of 31
- Motion Status Command 17

O

- Operation 10
- Operational Modes 3
- Ordering Information 61
- output activation time 1, 63
 - command 11
 - value 24
 - values 23

P

- Part Numbers 61
- performance
 - motion detection 1
- Pin Description 3
- Ping 41
- POR 8
 - voltage threshold 8, 9
- power consumption 3, 4, 7
- Power-On Reset – also see POR 8, 9
 - Digital Delay 59
 - Operation 9
- pyroelectric sensor 1, 8, 10, 47, 55, 58

R

- Range Setting 43
- Read
 - Command Structure 12
 - Frequency Response Setting 29
 - Hyper Sense Level Setting 27
 - Hyper Sense Setting 25
 - Motion Detected Unsolicited Mode 37
 - Motion Detection Suspend Setting 31
 - Motion Status 17
 - Ping Value 41
 - Range Setting 43
 - Sensitivity 45
 - Serial Interface Command Mode 35
- Read MD
 - Activation Time 23
 - Current Output Active Time 39
- Receive Data – also see RXD 7
- Related Documents 58
- Related Products 58
- Revision History iii
- RST 3, 7, 15, 21, 22
- RXD 3, 4, 5, 7, 10, 59, 64
 - input pin 11

S

- sensitivity 1, 25, 27, 29, 30, 55, 63
 - input 10
 - level 10

Sensitivity – also see SNS
 command 35
 commands 45
 Hardware Interface Mode 5
 Read 15, 45
 Write 15, 45
Serial Commands 15
 motion detected unsolicited mode 37
 read current light gate input level 18
 read dual direction mode 47
 read gate light threshold 19
 read MD/RST pin configuration 21
 write light gate threshold 19
 write MD/RST pin configuration 21
Serial Interface Command Mode 35
Serial Interface Mode 10, 11, 64
 application example schematic 64
 data transmission 7
 sensitivity 5
 signal descriptions 6
 software revision 33
Serial Interface Mode Selection 4
Setting Operation Mode 4
signal descriptions
 hardware interface mode 4
 serial interface mode 6
Sleep Mode – also see SLP 6, 8, 54
 in Hardware Interface Mode 11
 in Serial Interface Mode 12
SLP 3, 4, 6, 8, 10, 11, 12, 52, 59, 63, 64
 pin 54
SNS 3, 4, 5, 7, 10, 59
 pin 11
 signal 63
Software Revision 33
Supply Voltage 3, 4, 7, 8, 9, 59

T

Table of Contents iv
Transmit Data – also see TXD 7
TXD 3, 4, 5, 7, 10, 11, 59
 output pin 11
 pin 64

V

VBO 8
 voltage threshold 9
VDD 3, 4, 6, 7, 8, 59, 63
Voltage Brown-Out Protection and Power-On
 Reset – also see VBO, POR 8
VPOR 8, 9, 59

W

Write
 Command Structure 13
 Frequency Response Setting 29
 Hyper Sense Level Setting 28
 Hyper Sense Setting 25
 Motion Detected Unsolicited Mode 37
 Motion Detection Suspend Setting 31
 Ping Value 41
 Range Setting 43
 Sensitivity 45
 Serial Interface Command Mode 36
Write MD
 Activation Time 23
 Output State 40

Z

ZDM II 1, 2, 3, 4, 6, 8, 9, 10, 11, 12, 31, 35, 41, 45,
47, 51, 54, 58, 61, 65
 architectural overview 1
 block diagram 2
 commands 12
 Directional Detection 47
 features 1
 hardware interface mode 10
 image 2
 modes 4
 Module Reset 51
 motion detection suspend 31
 operational modes 3
 ordering information 61
 part numbers 61
 pin descriptions 3
 Ping 41
 related documents 58

right-angle 2
Sensitivity 45
Serial Interface Command Mode 35
serial interface mode 11
Sleep Mode 54
software revisions 65
straight angle 2
supply voltage 4
VBO/POR 8
ZEPIR0AxS02MODG Block Diagram 2
ZMOTION™ Detection Module II – also see
ZDMII 1, 2, 4, 29, 31, 33, 37, 51, 54, 55, 58, 61,
62

Customer Support

To share comments, get your technical questions answered, or report issues you may be experiencing with our products, please visit Zilog's Technical Support page at <http://support.zilog.com>.

To learn more about this product, find additional documentation, or to discover other facets about Zilog product offerings, please visit the Zilog Knowledge Base at <http://zilog.com/kb> or consider participating in the Zilog Forum at <http://zilog.com/forum>.

This publication is subject to replacement by a later edition. To determine whether a later edition exists, please visit the Zilog website at <http://www.zilog.com>.