

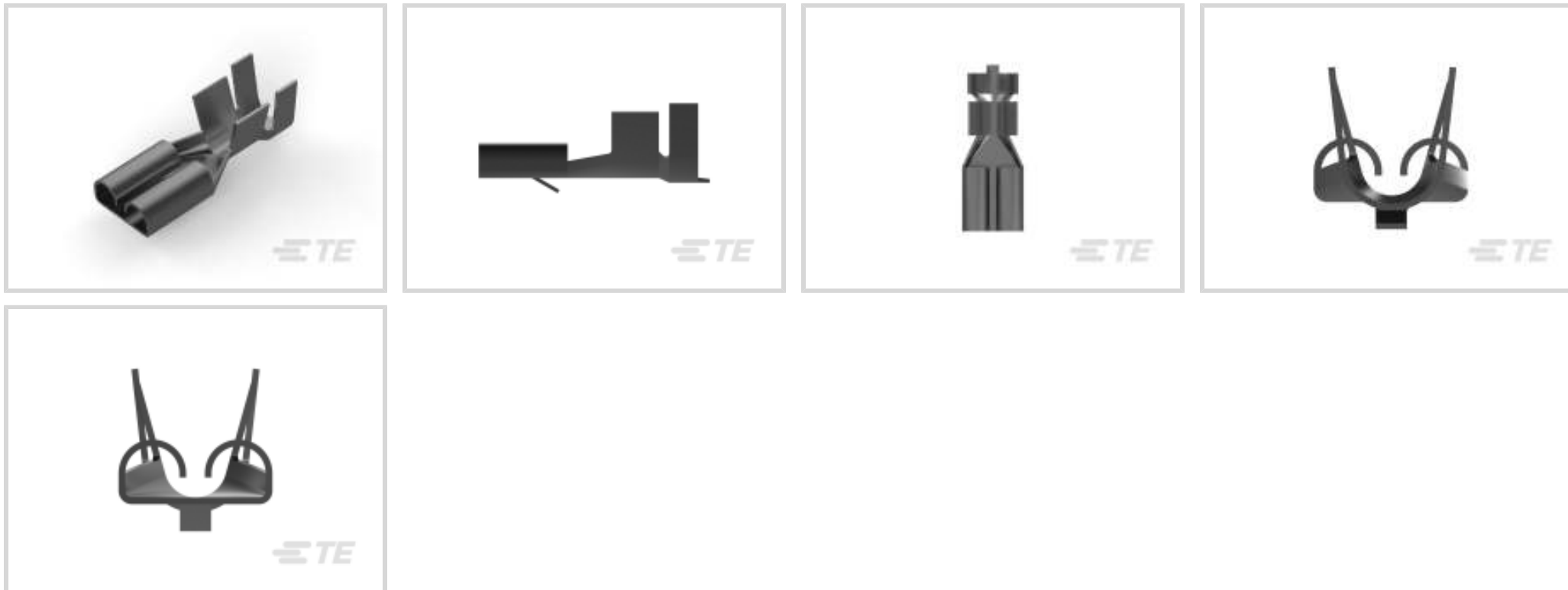

Terminals & Splices > Quick Disconnects



Quick Disconnect Terminal Type: **Receptacle**

Wire Size: **4 – 5.2 mm²**

Mating Tab Width: **6.35 mm [.25 in]**

Mating Tab Thickness: **.81 mm [.032 in]**

Features

Product Type Features

Insertion Force	Normal
-----------------	--------

Configuration Features

Connection Capacity	Single
Compatible With Wire & Cable Type	Discrete Wire

Electrical Characteristics

Voltage Rating	250 V
----------------	-------

Contact Features

Quick Disconnect Terminal Type	Receptacle
Mating Tab Width	6.35 mm [.25 in]
Mating Tab Thickness	.81 mm [.032 in]
Terminal Orientation	Straight
Contact Base Material	Phosphor Bronze
Terminal Plating Material	Tin
Crimp Type	F-Crimp



Barrel Type	Open
-------------	------

Termination Features

Product Terminates To	Wire & Cable
-----------------------	--------------

Mechanical Attachment

Wire Insulation Support	With
-------------------------	------

Mating Retention Type	Locking Lance
-----------------------	---------------

Dimensions

Terminal Material Thickness	.3 mm[.012 in]
-----------------------------	----------------

Product Length	20 mm[.787 in]
----------------	----------------

Compatible Insulation Diameter Range	3.43 – 5.08 mm[.135 – .2 in]
--------------------------------------	------------------------------

Wire Size	4 – 5.2 mm ²
-----------	-------------------------

Usage Conditions

Insulation Option	Uninsulated
-------------------	-------------

Operating Temperature Range	-40 – 110 °C[-40 – 230 °F]
-----------------------------	----------------------------

Industry Standards

Agency/Standard	UL
-----------------	----

Packaging Features

Packaging Quantity	500
--------------------	-----

Packaging Method	Loose Piece/Carton
------------------	--------------------

Product Compliance

[For compliance documentation, visit the product page on TE.com>](#)

EU RoHS Directive 2011/65/EU	Compliant
------------------------------	-----------

EU ELV Directive 2000/53/EC	Compliant
-----------------------------	-----------

China RoHS 2 Directive MIIT Order No 32, 2016	No Restricted Materials Above Threshold
---	---

EU REACH Regulation (EC) No. 1907/2006	Current ECHA Candidate List: JUNE 2023 (235) Candidate List Declared Against: JAN 2023 (233) Does not contain REACH SVHC
--	--

Halogen Content	Low Halogen - Br, Cl, F, I < 900 ppm per homogenous material. Also BFR/CFR/PVC Free
-----------------	---

Solder Process Capability	Not applicable for solder process capability
---------------------------	--

Product Compliance Disclaimer

This information is provided based on reasonable inquiry of our suppliers and represents our current actual knowledge based on the information they provided. This information is subject to change. The part numbers that TE has identified as EU RoHS compliant have a maximum concentration of 0.1% by weight in homogenous materials for lead, hexavalent chromium, mercury, PBB, PBDE, DBP, BBP, DEHP, DIBP, and 0.01% for cadmium, or qualify for an exemption to these limits as defined in the Annexes of Directive 2011/65/EU (RoHS2). Finished electrical and electronic equipment products will be CE marked as required by Directive 2011/65/EU. Components may not be CE marked. Additionally, the part numbers that TE has identified as EU ELV compliant have a maximum concentration of 0.1% by weight in homogenous materials for lead, hexavalent chromium, and mercury, and 0.01% for cadmium, or qualify for an exemption to these limits as defined in the Annexes of Directive 2000/53/EC (ELV). Regarding the REACH Regulation, the information TE provides on SVHC in articles for this part number is based on the latest European Chemicals Agency (ECHA) 'Guidance on requirements for substances in articles' posted at this URL: <https://echa.europa.eu/guidance-documents/guidance-on-reach>

Compatible Parts



TE Part # 1-1579007-4
EXTRACTION TOOL



TE Part # 4-1579007-3
EXTRACTION TOOL KIT



TE Part # 153259-3
FF 250 REC TPBR FOR PCB LP



TE Part # 539654-2
MATRIZE .250 FF



TE Part # 180250
HHHT FSTON/FF 375 POS LOC 250 6-2 ASSY



TE Part # 2379381-1
SDE F, FASTIN-FASTON, 4.0-6.0mm², ASSY



TE Part # 2379381-2
SDE F, FASTIN-FASTON, 4.0-6.0mm², DIE SET



TE Part # 539751-2
DIE F6.3FF

Also in the Series | FASTIN-FASTON 250

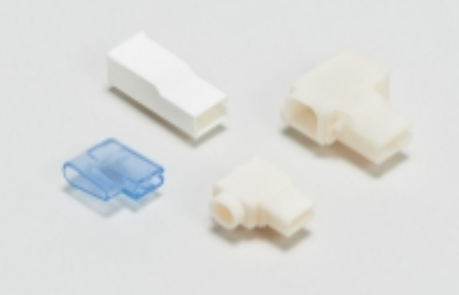

Crimp Terminal Housings(211)



Insertion & Extraction Tools(2)



PCB Terminals(2)



Quick Disconnects(254)

Customers Also Bought

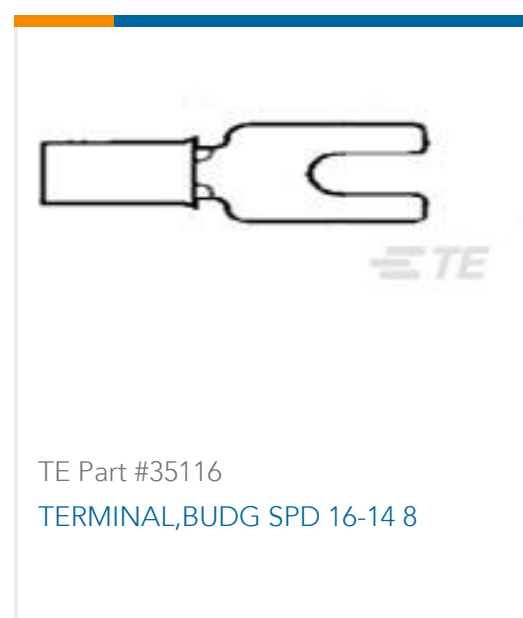
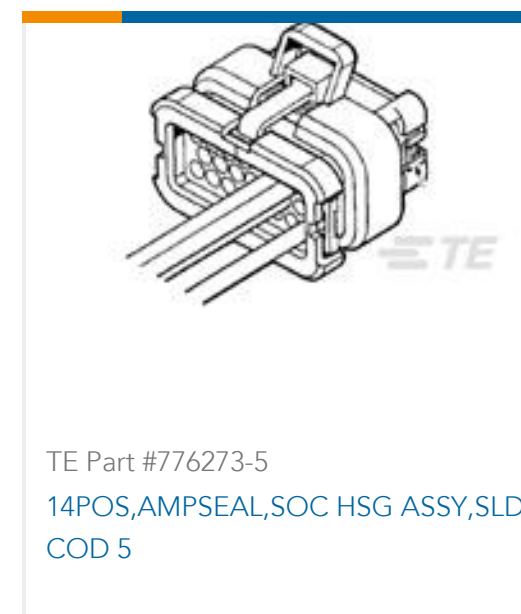

Documents

Product Drawings

[FF 250 REC 4-6MM2 TPPB LP](#)

English

CAD Files

Customer View Model

[ENG_CVM_CVM_180384-5_K.2d_dxf.zip](#)

English

3D PDF

3D

Customer View Model

[ENG_CVM_CVM_180384-5_K.3d_igs.zip](#)

English

Customer View Model

[ENG_CVM_CVM_180384-5_K.3d_stp.zip](#)

English

By downloading the CAD file I accept and agree to the [Terms and Conditions](#) of use.

Datasheets & Catalog Pages



1654742_HOUSEHOLD_APPLIANCES_RAST5

English

Product Specifications

.110,.187 & 250 Series FASTON Terminals

English

Product Specification

English