

User Manual

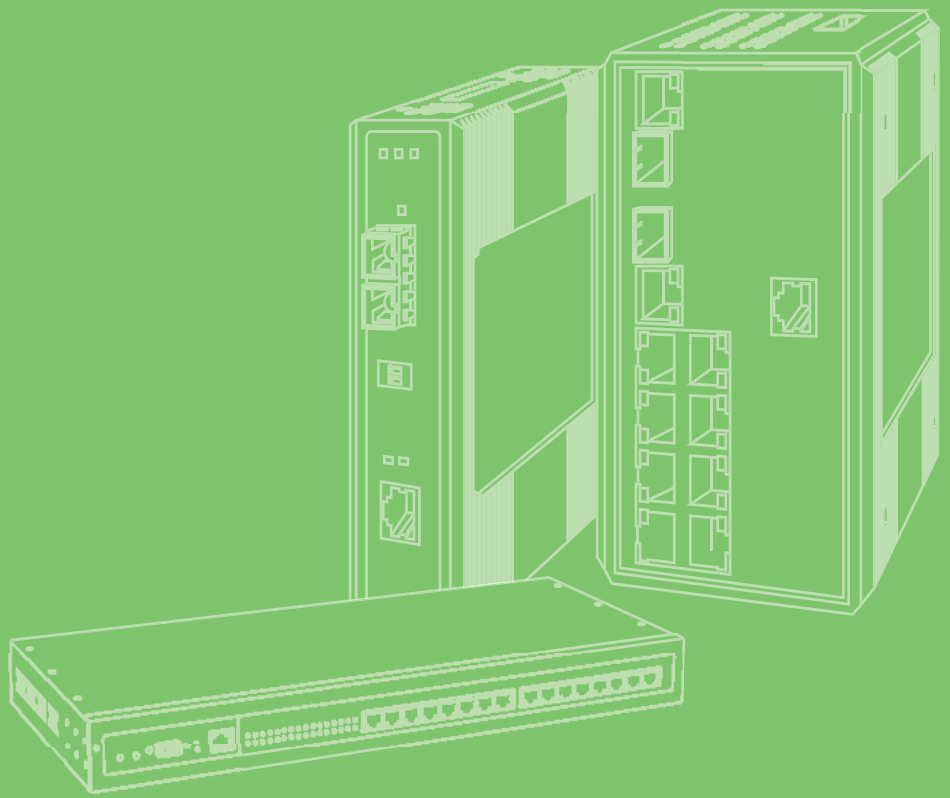

EKI-1511 Series

1-Port RS-232/422/485
Serial Device Server

ADVANTECH

Enabling an Intelligent Planet

Copyright

The documentation and the software included with this product are copyrighted 2018 by Advantech Co., Ltd. All rights are reserved. Advantech Co., Ltd. reserves the right to make improvements in the products described in this manual at any time without notice. No part of this manual may be reproduced, copied, translated or transmitted in any form or by any means without the prior written permission of Advantech Co., Ltd. Information provided in this manual is intended to be accurate and reliable. However, Advantech Co., Ltd. assumes no responsibility for its use, nor for any infringements of the rights of third parties, which may result from its use.

Acknowledgments

Intel and Pentium are trademarks of Intel Corporation.

Microsoft Windows and MS-DOS are registered trademarks of Microsoft Corp.

All other product names or trademarks are properties of their respective owners.

Product Warranty (5 years)

Advantech warrants to you, the original purchaser, that each of its products will be free from defects in materials and workmanship for five years from the date of purchase.

This warranty does not apply to any products which have been repaired or altered by persons other than repair personnel authorized by Advantech, or which have been subject to misuse, abuse, accident or improper installation. Advantech assumes no liability under the terms of this warranty as a consequence of such events.

Because of Advantech's high quality-control standards and rigorous testing, most of our customers never need to use our repair service. If an Advantech product is defective, it will be repaired or replaced at no charge during the warranty period. For out-of-warranty repairs, you will be billed according to the cost of replacement materials, service time and freight. Please consult your dealer for more details.

If you think you have a defective product, follow these steps:

1. Collect all the information about the problem encountered. (For example, CPU speed, Advantech products used, other hardware and software used, etc.) Note anything abnormal and list any on-screen messages you get when the problem occurs.
2. Call your dealer and describe the problem. Please have your manual, product, and any helpful information readily available.
3. If your product is diagnosed as defective, obtain an RMA (return merchandise authorization) number from your dealer. This allows us to process your return more quickly.
4. Carefully pack the defective product, a fully-completed Repair and Replacement Order Card and a photocopy proof of purchase date (such as your sales receipt) in a shippable container. A product returned without proof of the purchase date is not eligible for warranty service.
5. Write the RMA number visibly on the outside of the package and ship it prepaid to your dealer.

Declaration of Conformity

CE

This product has passed the CE test for environmental specifications. Test conditions for passing included the equipment being operated within an industrial enclosure. In order to protect the product from being damaged by ESD (Electrostatic Discharge) and EMI leakage, we strongly recommend the use of CE-compliant industrial enclosure products.

FCC Class A

Note: This equipment has been tested and found to comply with the limits for a Class A digital device, pursuant to part 15 of the FCC Rules. These limits are designed to provide reasonable protection against harmful interference when the equipment is operated in a commercial environment. This equipment generates, uses, and can radiate radio frequency energy and, if not installed and used in accordance with the instruction manual, may cause harmful interference to radio communications. Operation of this equipment in a residential area is likely to cause harmful interference in which case the user will be required to correct the interference at his own expense.

Technical Support and Assistance

1. Visit the Advantech web site at www.advantech.com/support where you can find the latest information about the product.
2. Contact your distributor, sales representative, or Advantech's customer service center for technical support if you need additional assistance. Please have the following information ready before you call:
 - Product name and serial number
 - Description of your peripheral attachments
 - Description of your software (operating system, version, application software, etc.)
 - A complete description of the problem
 - The exact wording of any error messages

Warnings, Cautions and Notes

Warning! *Warnings indicate conditions, which if not observed, can cause personal injury!*



Caution! *Cautions are included to help you avoid damaging hardware or losing data. e.g.*



There is a danger of a new battery exploding if it is incorrectly installed. Do not attempt to recharge, force open, or heat the battery. Replace the battery only with the same or equivalent type recommended by the manufacturer. Discard used batteries according to the manufacturer's instructions.

Note! *Notes provide optional additional information.*



Document Feedback

To assist us in making improvements to this manual, we would welcome comments and constructive criticism. Please send all such - in writing to: support@advantech.com

Packing List

Before setting up the system, check that the items listed below are included and in good condition. If any item does not accord with the table, please contact your dealer immediately.

- 1 x Serial Device Server
- 1 x DIN-Rail Mounting Bracket and Screws

Safety Instructions

- Read these safety instructions carefully.
- Keep this User Manual for later reference.
- Disconnect this equipment from any DC outlet before cleaning. Use a damp cloth. Do not use liquid or spray detergents for cleaning.
- For plug-in equipment, the power outlet socket must be located near the equipment and must be easily accessible.
- Keep this equipment away from humidity.
- Put this equipment on a reliable surface during installation. Dropping it or letting it fall may cause damage.
- The openings on the enclosure are for air convection. Protect the equipment from overheating. **DO NOT COVER THE OPENINGS.**
- Make sure the voltage of the power source is correct before connecting the equipment to the power outlet.
- Position the power cord so that people cannot step on it. Do not place anything over the power cord.
- All cautions and warnings on the equipment should be noted.
- If the equipment is not used for a long time, disconnect it from the power source to avoid damage by transient over voltage.
- Never pour any liquid into an opening. This may cause fire or electrical shock.
- Never open the equipment. For safety reasons, the equipment should be opened only by qualified service personnel.
- If one of the following situations arises, get the equipment checked by service personnel:
 - The power cord or plug is damaged.
 - Liquid has penetrated into the equipment.
 - The equipment has been exposed to moisture.
 - The equipment does not work well, or you cannot get it to work according to the user's manual.
 - The equipment has been dropped and damaged.
 - The equipment has obvious signs of breakage.
- **DO NOT LEAVE THIS EQUIPMENT IN AN ENVIRONMENT WHERE THE STORAGE TEMPERATURE MAY GO -40°C (-40°F) ~ 85°C (185°F). THIS COULD DAMAGE THE EQUIPMENT. THE EQUIPMENT SHOULD BE IN A CONTROLLED ENVIRONMENT.**
- The sound pressure level at the operator's position according to IEC 704-1:1982 is no more than 70 dB (A).

DISCLAIMER: This set of instructions is given according to IEC 704-1. Advantech disclaims all responsibility for the accuracy of any statements contained herein.

Safety Precaution - Static Electricity

Static electricity can cause bodily harm or damage electronic devices. To avoid damage, keep static-sensitive devices in the static-protective packaging until the installation period. The following guidelines are also recommended:

- Wear a grounded wrist or ankle strap and use gloves to prevent direct contact to the device before servicing the device. Avoid nylon gloves or work clothes, which tend to build up a charge.
- Always disconnect the power from the device before servicing it.
- Before plugging a cable into any port, discharge the voltage stored on the cable by touching the electrical contacts to the ground surface.

Contents

Chapter 1	Introduction	1
1.1	Overview	2
1.2	Device Features	2
Chapter 2	Getting Started	3
2.1	Specifications	4
2.2	Hardware	6
2.2.1	Front View	6
2.2.2	Rear View	7
2.2.3	Top View	7
2.2.4	Bottom View	8
2.2.5	LED Indicators	9
2.2.6	Dimensions	9
2.3	Connecting Hardware	10
2.3.1	DIN Rail Mounting	10
2.3.2	Wall-Mounting	13
2.3.3	Power Adapter Connection	14
2.3.4	Serial Connection	15
2.3.5	Power Connection	16
Chapter 3	Utility Configuration	17
3.1	Installing the Configuration Utility	18
3.2	Starting the Configuration Utility	21
3.3	Discovering Your Device Server	22
3.3.1	Auto Searching	22
3.3.2	Network Settings	24
3.4	Administrator Settings	26
3.4.1	Locate the Serial Device Server	26
3.4.2	Securing the Serial Device Server	27
3.4.3	Restore to Factory Default Settings	29
3.4.4	Resetting the Device	30
3.4.5	Add to Favorite	31
3.4.6	Auto Mapping	31
3.4.7	Manual Mapping	31
3.4.8	Update Firmware	32
Chapter 4	Selecting An Operating Mode	33
4.1	Overview	34
4.2	COM Port Redirector (Virtual COM Port)	34
4.2.1	Normal mode	35
4.2.2	Round-Robin mode	35
4.3	USDG Data Mode	36
4.3.1	USDG TCP Client Mode	36
4.3.2	USDG Data TCP Server mode	37
4.3.3	USDG UDP Server/Client mode	37
4.4	USDG Control Mode	39
4.4.1	Hangup Character	39
4.4.2	Guard Time	39
4.5	RFC2217 Mode	40

Chapter	5	Setting up Virtual COM Port.....	41
5.1		Setting COM Port Redirector	42
5.2		Virtual COM Port Mapping	42
	5.2.1	Auto Mapping.....	42
	5.2.2	Manual Mapping	44
	5.2.3	Configuration Wizard	45
	5.2.4	Confirming Virtual COM Settings.....	46
	5.2.5	Removing VCOM Ports	48
	5.2.6	Exporting and Importing VCOM Mapping.....	49
5.3		Running a Diagnostic Test.....	49
Chapter	6	Web Interface	50
6.1		Overview	51
6.2		Accessing the Web Page.....	51
	6.2.1	Accessing the Web Page via Configuration Utility.....	51
	6.2.2	Accessing the Web Page via Web Browser	52
6.3		System.....	52
6.4		Ethernet Configuration	52
6.5		Port Configuration	54
	6.5.1	Basic.....	54
	6.5.2	Operation	54
	6.5.3	Advanced.....	56
6.6		Monitor.....	56
	6.6.1	Setting.....	57
	6.6.2	Statistic	58
	6.6.3	Connected IP	59
6.7		Auto Warning (Alarm)	60
	6.7.1	Setting.....	60
	6.7.2	Event.....	62
6.8		Syslogd	62
	6.8.1	Syslogd Setting.....	62
	6.8.2	Syslogd Message	63
6.9		Tools	64
	6.9.1	Ping.....	64
	6.9.2	Reboot	65
6.10		Management.....	65
	6.10.1	Log File	65
	6.10.2	Change Password	66
	6.10.3	Secure access IP.....	66
	6.10.4	Export Device Settings	66
	6.10.5	Import Device Settings.....	67
Chapter	7	Telnet/Serial Console Configuration	68
7.1		Overview	69
7.2		Telnet Console.....	69
	7.2.1	Create a new connection	69
	7.2.2	Input the IP address.....	70
	7.2.3	Connection Success	70
7.3		Command List.....	71
	7.3.1	system	71
	7.3.2	port.....	71
	7.3.3	portadv	72
	7.3.4	mvcom	72
	7.3.5	mctrl	72
	7.3.6	mdata.....	73

7.3.7	net.....	73
7.3.8	password.....	73
7.3.9	alarm.....	73
7.3.10	monitor.....	74
7.3.11	time.....	74
7.3.12	service.....	75
7.3.13	mrfc2217.....	75
7.3.14	apply.....	75
7.3.15	exit.....	75
7.3.16	help.....	75
7.3.17	reboot.....	75

Chapter 8 TCP and UDP Port Numbers.....76

8.1	List of Known TCP and UDP Port Numbers.....	77
-----	---	----

List of Figures

Figure 2.1	Front View	6
Figure 2.2	Rear View	7
Figure 2.3	Top View	7
Figure 2.4	Bottom View	8
Figure 2.5	Left View.....	8
Figure 2.6	System LED Panel	9
Figure 2.7	Dimensions.....	9
Figure 2.8	Installing the DIN Bracket.....	10
Figure 2.9	Installing the DIN-Rail Mounting Kit.....	11
Figure 2.10	Correctly Installed DIN Rail Kit.....	11
Figure 2.11	Removing the DIN-Rail.....	12
Figure 2.12	Installing Wall Mount Plates	13
Figure 2.13	Securing Wall Mounting Screws.....	14
Figure 2.14	Wall Mount Installation	14
Figure 2.15	Power Adapter Electrode Label Indication	15
Figure 2.16	DB9 Pin Assignment	15
Figure 2.17	RS-422/485 Pin Assignment	15
Figure 2.18	Power Wiring for EKI-1511 Series.....	16
Figure 3.1	InstallShield Wizard 1 of 4	18
Figure 3.2	InstallShield Wizard 2 of 4	19
Figure 3.3	InstallShield Wizard 3 of 4	19
Figure 3.4	InstallShield Wizard 4 of 4	20
Figure 3.5	Configuration Utility Overview	21
Figure 3.6	Open View of Serial Device Configuration Utility	22
Figure 3.7	Selecting a Group.....	23
Figure 3.8	Selecting a Device.....	23
Figure 3.9	Viewing Basic Settings	23
Figure 3.10	Utility Overview.....	24
Figure 3.11	Network Settings Overview	25
Figure 3.12	Locate the Serial Device Server.....	26
Figure 3.13	Lock the Serial Device Server	27
Figure 3.14	Enter a Password.....	27
Figure 3.15	Reset Device	28
Figure 3.16	Unlock the Serial Device Server.....	28
Figure 3.17	Restore to Factory Default Settings	29
Figure 3.18	Reset Device	30
Figure 3.19	Add to Favorite	31
Figure 3.20	Update Firmware.....	32
Figure 4.1	Virtual COM Mode.....	34
Figure 4.2	Configuring Virtual COM Mode	35
Figure 4.3	USDG TCP Client Mode.....	36
Figure 4.4	Peers for Receiving Data	36
Figure 4.5	USDG TCP Server Mode	37
Figure 4.6	USDG Data Mode	37
Figure 4.7	USDG Control Mode	39
Figure 4.8	RFC2217 Mode	40
Figure 5.1	Selecting Auto Mapping	42
Figure 5.2	Selecting Auto Mapping	43
Figure 5.3	Mapping Selected Ports	43
Figure 5.4	Viewing VCOM Mapping Results	43
Figure 5.5	Selecting Manual Mapping	44
Figure 5.6	Manual Mapping of Host Port.....	44
Figure 5.7	Manual Mapping of a Virtual COM Port.....	45
Figure 5.8	Selecting the Configuration Wizard	45
Figure 5.9	Serial Port Listing on EKI-1511 Series Device	46
Figure 5.10	System Port VCOM Mapping Configuration.....	47

Figure 5.11	Verifying VCOM Mapping Configuration.....	47
Figure 5.12	Remove VCOM Port.....	48
Figure 6.1	Accessing the Web Page via Configuration Utility.....	51
Figure 6.2	System.....	52
Figure 6.3	Ethernet Configuration.....	53
Figure 6.4	Port Configuration > Basic.....	54
Figure 6.5	Port Configuration > Operation.....	55
Figure 6.6	Port Configuration > Operation.....	56
Figure 6.7	Monitor > Setting.....	57
Figure 6.8	Monitor > Statistic.....	58
Figure 6.9	Monitor > Connected IP.....	59
Figure 6.10	Alarm > Setting.....	60
Figure 6.11	Alarm > Event.....	62
Figure 6.12	Syslogd > Syslogd Setting.....	63
Figure 6.13	Syslogd > Syslogd Message.....	63
Figure 6.14	Tools > Ping.....	64
Figure 6.15	Tools > Reboot.....	65
Figure 6.16	Management > Log File.....	65
Figure 6.17	Management > Change Password.....	66
Figure 6.18	Management > Secure access IP.....	66
Figure 6.19	Management > Import.....	67
Figure 7.1	Creating a Telnet Connection.....	69
Figure 7.2	Creating a Telnet Connection.....	70
Figure 7.3	Telnet Connection Console.....	70

Chapter 1

Introduction

1.1 Overview

The EKI-1511 series focus on the entry level device server market, providing an economic solution that is designed to connect RS-232 or RS-422/485 serial devices such as PLC, meters, sensors, and barcode readers to an IP-based Ethernet LAN. This allows nearly any device with a serial port to connect and share an Ethernet network, while also providing various operations such as COM port redirection (Virtual COMport), TCP server, TCP client, and UDP mode. With COM port redirection mode, standard serial operation calls are transparently redirected to the servers, guaranteeing compatibility with legacy serial devices and enabling backward-compatibility with existing software. With TCP server, TCP client, and UDP modes, the EKI-1511 series ensure compatibility in network software using a standard network API. Serial devices can communicate with other devices via peer-to-peer, thus eliminating the need for an intermediate host PC and software programming.

1.2 Device Features

- 1 x 10/100 Mbps Ethernet port
- Provides COM port redirection (Virtual COM), TCP, and UDP operation modes
- Baud rate supports up to 230.4 kbps
- Maximum of five hosts can access one serial port
- Maximum of 16 hosts accessed in TCP client mode
- Built-in 8-kV ESD protection for all serial signals
- Provides multiple configuration methods including Windows utility, Telnet console, and web browser. Supports 32/64-bit Windows 2000/XP/Vista/7/8/8.1/10, Windows Server 2003/2008/2012, and Linux
- "I" models support a wide operating temperature

Chapter 2

Getting Started

2.1 Specifications

Specifications	Description	
Interface	I/O Port	EKI-1511L: 1 x RJ45 + 1 x RS-232 EKI-1511IL: 1 x RJ45 + 1 x RS-232 EKI-1511X: 1 x RJ45 + 1 x RS-422/485
	Power Connector	Terminal block
Physical	Enclosure	Metal with solid mounting hardware
	Installation	DIN-rail and Wall mount
	Dimensions (W x H x D)	46 x 85.1 x 21.2 mm (1.81" x 3.35" x 0.83")
LED Display	System LED	Power, Status
	Port LED	Status/LAN: Speed, Link/Active Serial: Tx, Rx
Environment	Operating Temperature	-10°C ~ 60°C (14°F ~ 140°F) I models: -40 ~ 75 °C (-40 ~ 167 °F)
	Storage Temperature	-40°C ~ 85°C (-40°F ~ 185°F)
	Ambient Relative Humidity	10 ~ 95% RH
Ethernet Communications	Compatibility	IEEE 802.3, IEEE 802.3u
	Speed	10/100 Mbps
	Port Connector	1 x 8-pin RJ45
	Protection	Built-in 2.25 k VDC magnetic isolation
Serial Communications	Port Type	L: RS-232; X: RS-422/485
	Port Connector	1 x DB9 male
	Data Bits	5, 6, 7, 8
	Stop Bits	1, 1.5, 2
	Parity	None, Odd, Even, Space, Mark
	Flow Control	XON/XOFF, RTS/CTS
	Baud Rate	300 bps ~ 230.4 kbps
	Serial Signals	RS-232: TxD, RxD, CTS, RTS, GND RS-422: TxD+, TxD-, RxD+, RxD-, GND RS-485 2-wire: Data+, Data-, GND RS-485 4-wire: TxD+, TxD-, RxD+, RxD- GND
Protection	Built-in 8 KV ESD for all signals	
Power	Power Consumption	1W
	Power Input	9 ~ 36V _{DC}
Software	Driver Support	32-bit/64-bit Windows 2000/XP/Vista/7/8/8.1/10, Windows Server 2003/2008/2012, and Linux
	Utility	Advantech EKI Device Configuration Utility
	Operation Modes	<ul style="list-style-type: none"> ■ COM port redirection mode (Virtual COM) ■ TCP/UDP server (polling) mode ■ TCP/UDP client (event handling) mode ■ Pair connection (peer to peer) mode
	Configuration	Windows utility, Telnet Console, Web Browser
	Management	SNMP MIB-II
	Protocols	ICMP, IP, TCP, UDP, BOOTP, DHCP, Auto IP, SNMP, HTTP, DNS, SMTP, ARP, NTP

Specifications	Description	
Regulatory Approvals	EMC	CE, FCC Part 15 Subpart B (Class A)

2.2 Hardware

2.2.1 Front View

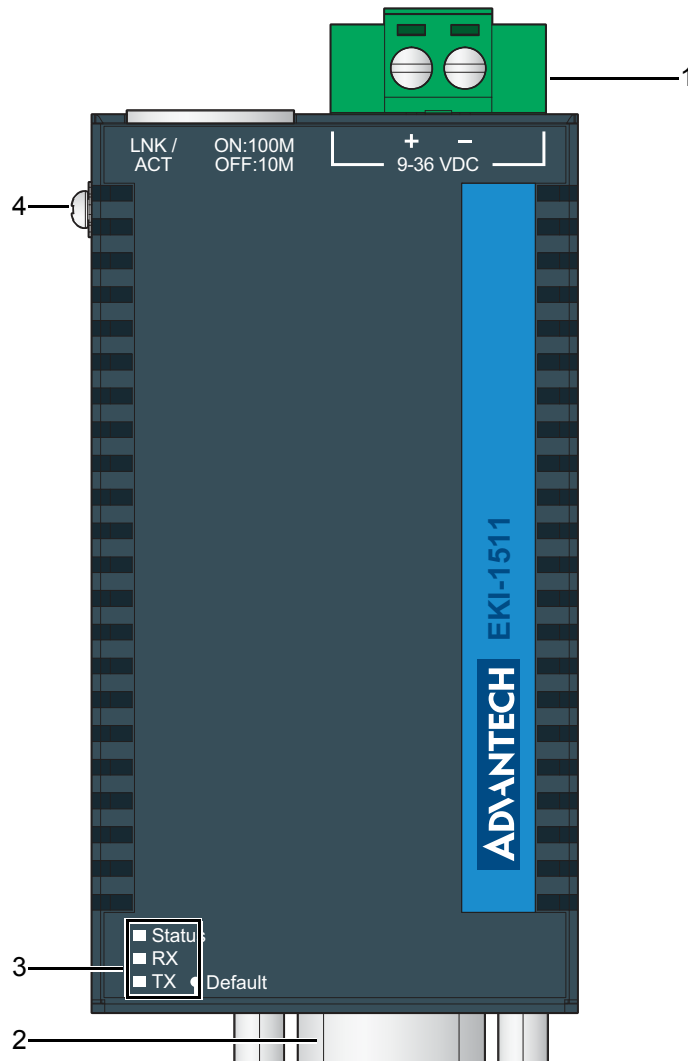

Figure 2.1 Front View

No.	Item	Description
1.	Terminal block	Connect cabling for power wiring
2.	Serial port	DB9 pin-out, supports L: RS-232, X: RS-422/485
3.	System LED panel	See “LED Indicators” on page 9 for further details.
4.	Ground terminal	Screw terminal used to ground chassis

2.2.2 Rear View

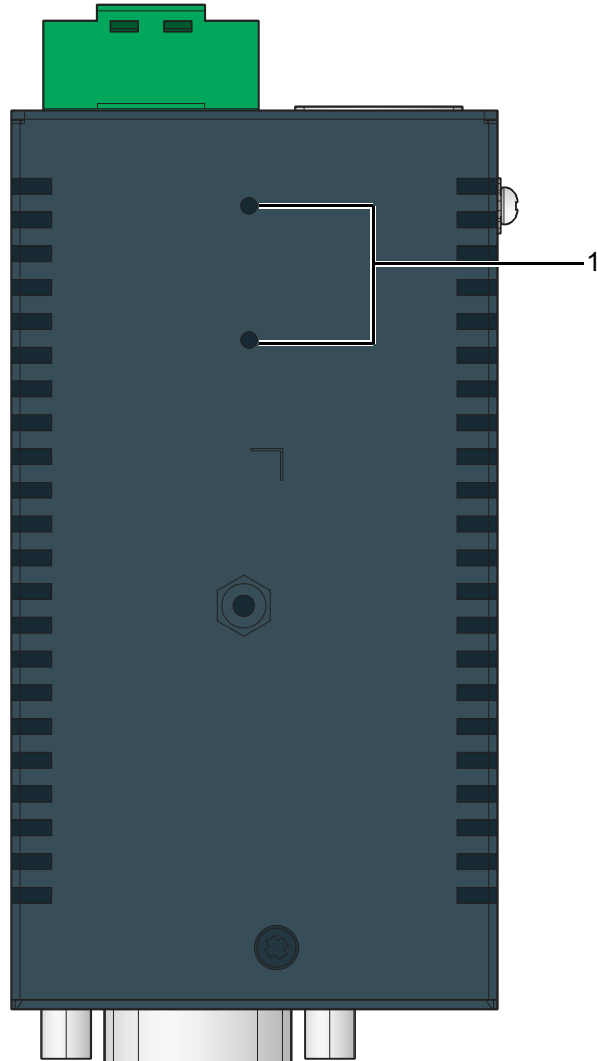

Figure 2.2 Rear View

No.	Item	Description
1.	M2 screw holes	Screw holes (2) used in the installation of a DIN mounting bracket or wall mounting

2.2.3 Top View

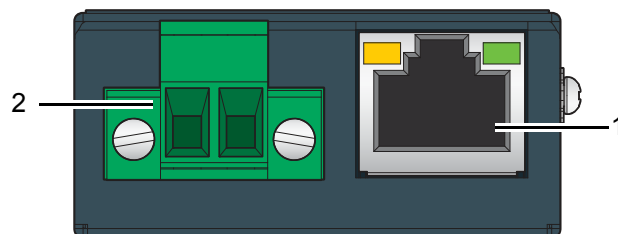

Figure 2.3 Top View

No.	Item	Description
1.	ETH port	RJ45 ports x 1
2.	Terminal block	Connect cabling for power wiring

2.2.4 Bottom View

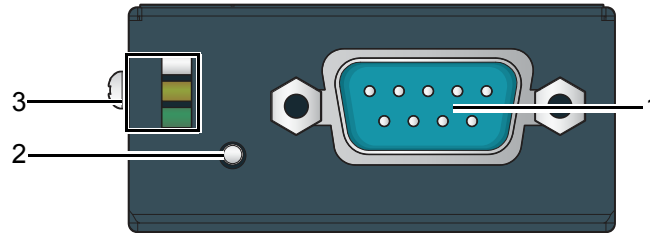

Figure 2.4 Bottom View

No.	Item	Description
1.	Serial port	DB9 pin-out, supports L: RS-232, X: RS-422/485
2.	Reset button	<ul style="list-style-type: none"> ■ Reset to factory default, press and hold until status indicator blinks ■ System reboot, press and hold for 2 seconds
3.	System LED panel	See “LED Indicators” on page 9 for further details

Left View

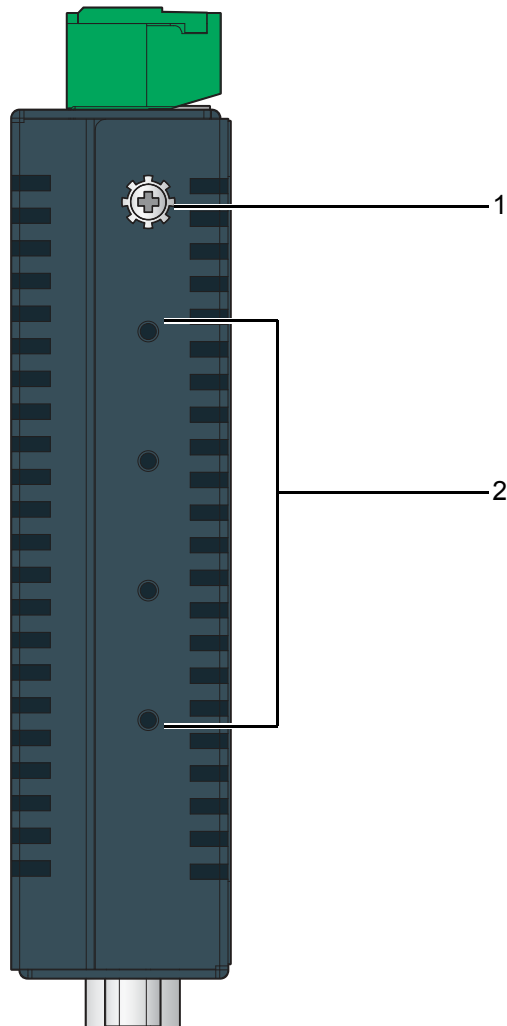

Figure 2.5 Left View

No.	Item	Description
1.	Ground terminal	Screw terminal used to ground chassis
2.	M2 screw holes	Screw holes (4) for DIN brackets or wall mounting

2.2.5 LED Indicators

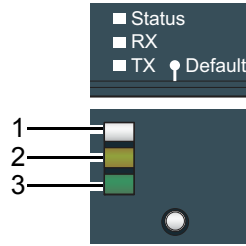

Figure 2.6 System LED Panel

No.	LED Name	LED Color	Status	Description
1.	Status/Power	Blue, blinking	On	Heartbeat (1 time/sec.)
		Off	Off	System is not working
2.	Rx (Serial)	Amber	On	Data being received
			Off	No data being received
3.	Tx (Serial)	Green	On	Data being transmitted
			Off	No data being transmitted

2.2.6 Dimensions

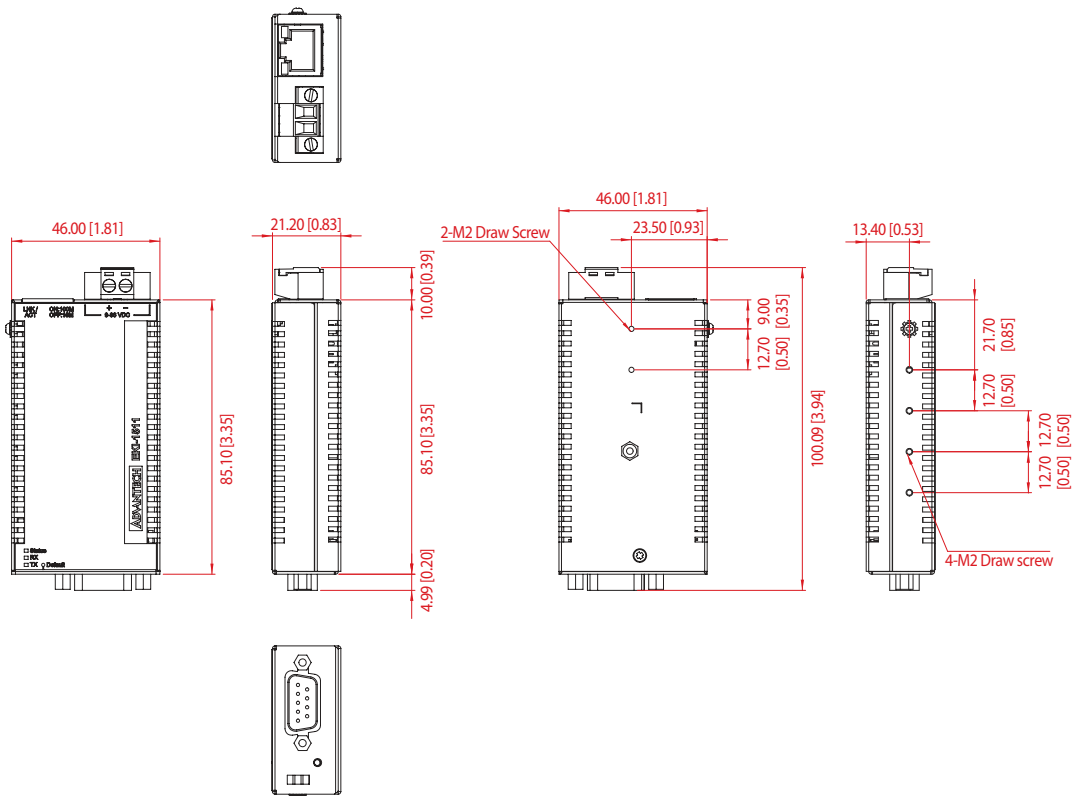

Figure 2.7 Dimensions

2.3 Connecting Hardware

2.3.1 DIN Rail Mounting

The DIN rail mount option is the quickest installation option. Additionally, it optimizes the use of rail space.

The metal DIN rail kit is secured to the rear of the switch. The device can be mounted onto a standard 35 mm (1.37") x 7.5 mm (0.3") height DIN rail. The devices can be mounted vertically or horizontally. Refer to the following guidelines for further information.

Note! A corrosion-free mounting rail is advisable.



When installing, make sure to allow for enough space to properly install the cabling.

2.3.1.1 Installing the DIN-Rail Mounting Kit

1. Align the provided DIN bracket with the device. The bracket can be installed on the left or rear side of the device to accommodate various environments. For this demonstration, the bracket is depicted on the rear of the device.
2. Insert the provided screws and tighten them to secure the bracket to the device.

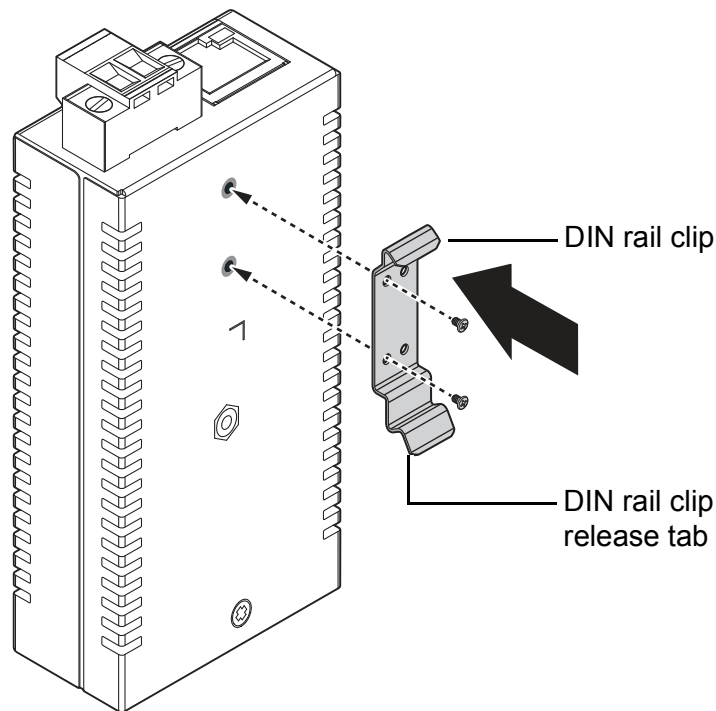

Figure 2.8 Installing the DIN Bracket

3. Position the rear panel of the switch directly in front of the DIN rail, making sure that the top of the DIN rail clip hooks over the top of the DIN rail, as shown in the following illustration.

Warning! Do not install the DIN rail under or in front of the spring mechanism on the DIN rail clip to prevent damage to the DIN rail clip or the DIN rail.



Make sure the DIN rail is inserted behind the spring mechanism.

4. Once the DIN rail is seated correctly in the DIN rail clip, press the front of the switch to rotate the switch down and into the release tab on the DIN rail clip. If seated correctly, the bottom of the DIN rail should be fully inserted in the release tab.

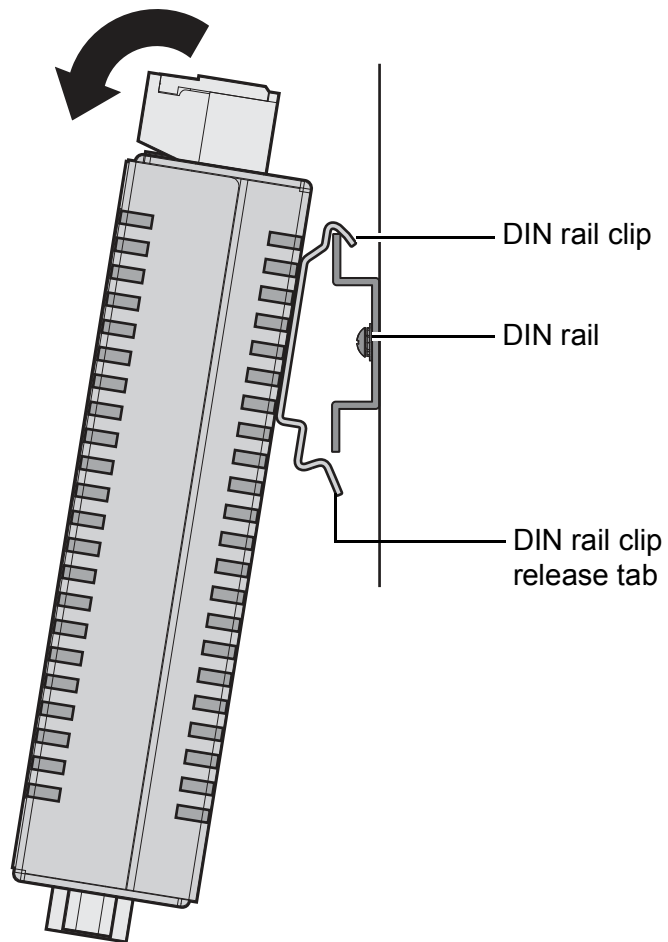

Figure 2.9 Installing the DIN-Rail Mounting Kit

See the following figure for an illustration of a completed DIN installation procedure.

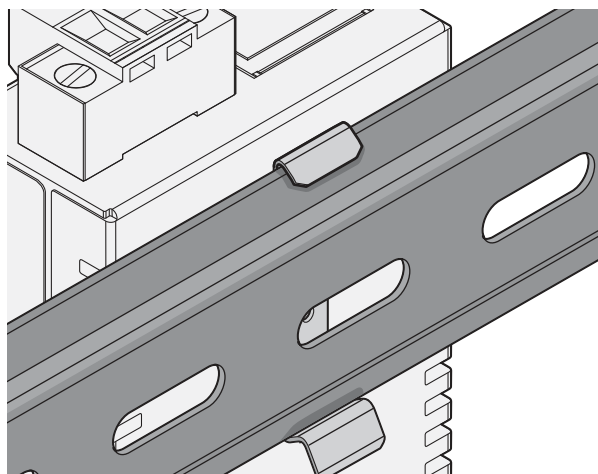

Figure 2.10 Correctly Installed DIN Rail Kit

5. Grasp the bottom of the switch and slightly rotate it upwards. If there is resistance, the switch is correctly installed. Otherwise, re-attempt the installation process from the beginning.

2.3.1.2 Removing the DIN-Rail Mounting Kit

1. Ensure that power is removed from the switch, and disconnect all cables and connectors from the front panel of the switch.
2. Push down on the top of the DIN rail clip release tab with your finger. As the clip releases, lift the bottom of the switch, as shown in the following illustration.

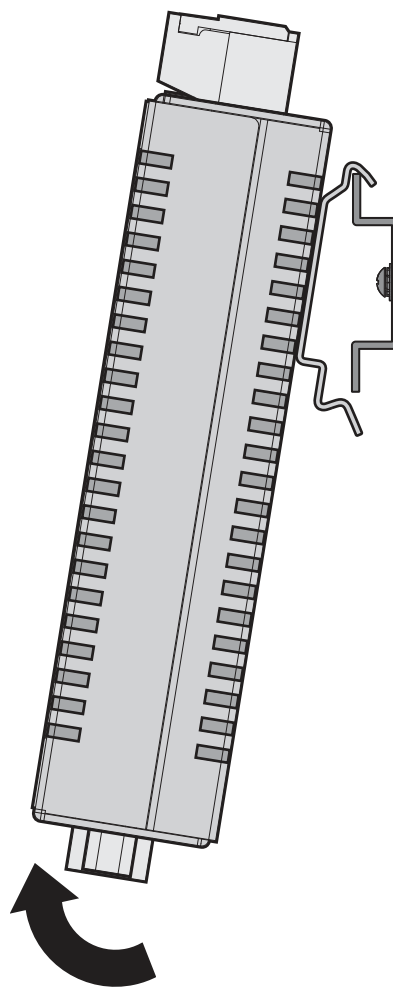

Figure 2.11 Removing the DIN-Rail

2.3.2 Wall-Mounting

The wall mounting option provides better shock and vibration resistance than the DIN rail vertical mount.

Note! *When installing, make sure to allow for enough space to properly install the cabling.*



Before the device can be mounted on a wall, you will need to remove the DIN rail plate.

1. Align the wall mounting plate with the rear side of the device. The screw holes on the device and the mounting plates must be aligned, see the following figure.
2. Secure the wall mount plates with the provided screws, see the following figure.

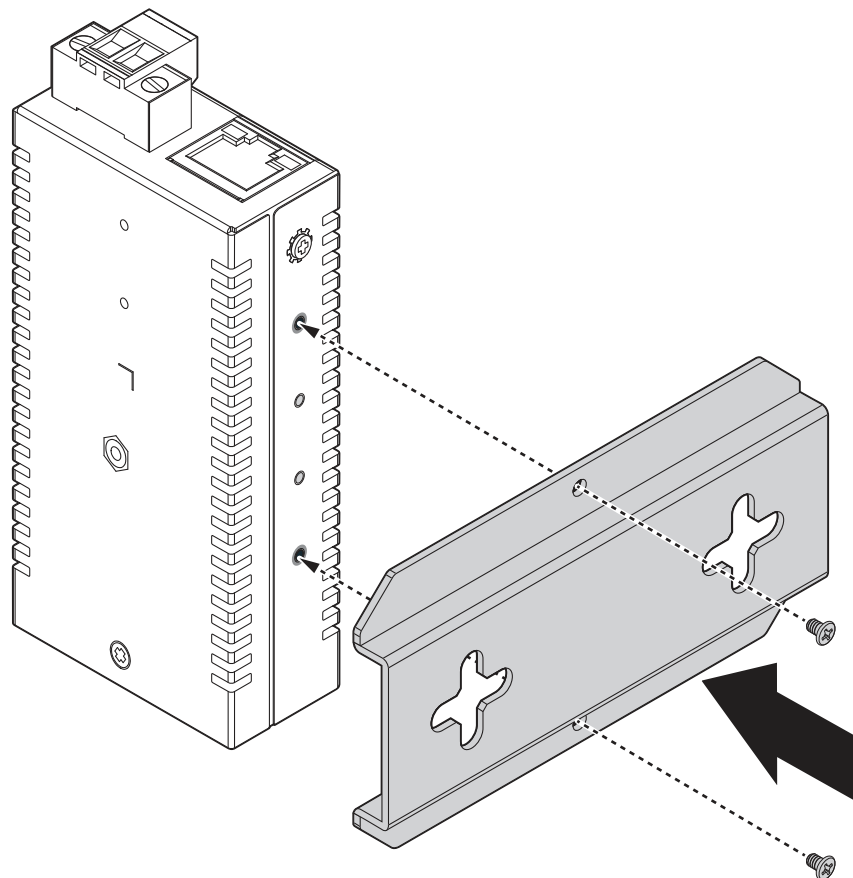

Figure 2.12 Installing Wall Mount Plates

Once the wall mounting plates are secure on the device, you will need to attach the wall screws (x 2).

3. Locate the installation site and place the mount plate against the wall, making sure it is the final installation location.
4. Use the plates as a guide to mark the locations of the screw holes.
5. Drill two holes over the marked locations on the wall, keeping in mind that the holes must accommodate the width of the wall sinks in addition to the screws.
6. Insert the wall sinks into the walls.

7. Insert the screws into the wall sinks. Leave a 2 mm gap between the wall and the screw head to allow for wall mount plate insertion.



Figure 2.13 Securing Wall Mounting Screws

- Note!**
- Make sure the screws dimensions are suitable for use with the wall mounting plate.
 - Do not completely tighten the screws into the wall. A final adjustment may be needed before fully securing the wall mounting plates on the wall.

8. Align the wall mount plate over the screws on the wall.
9. Install the wall mount plate on the screws and slide in the direction to lock it over the keyhole, see the following figure.

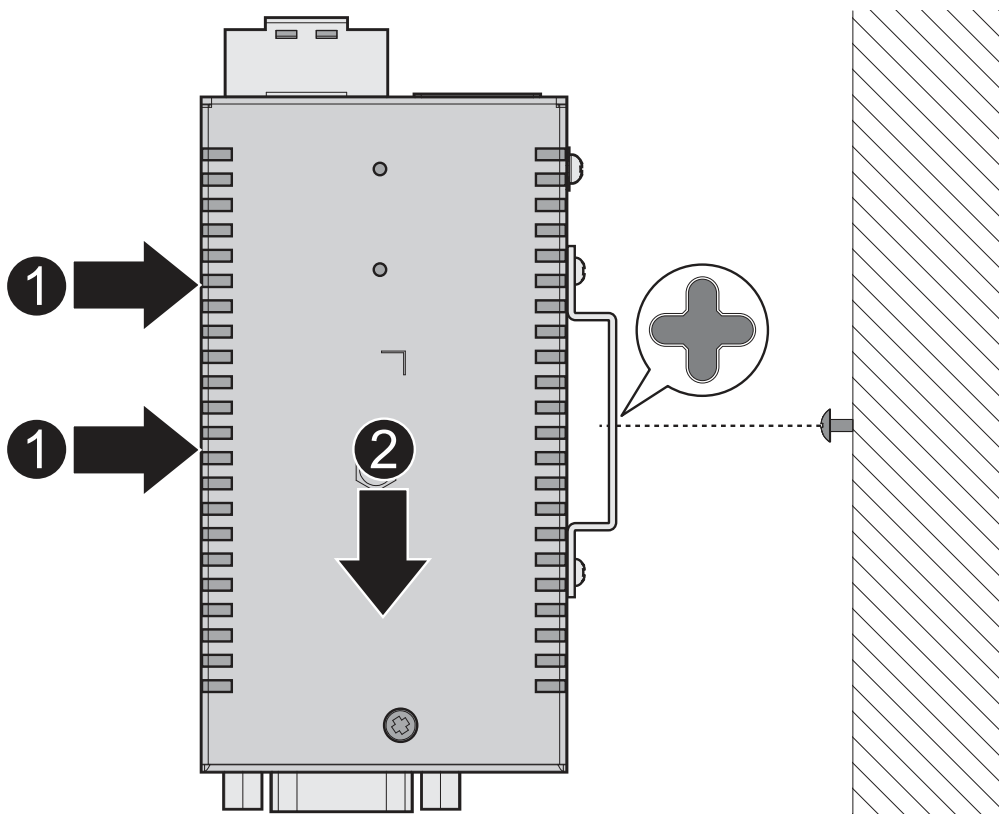

Figure 2.14 Wall Mount Installation

10. Once the device is installed on the wall, tighten the screws to secure the device.

2.3.3 Power Adapter Connection

Three types of power adapters are provided to accommodate power requirements. The adapter types are as follows:

- OPT1-PSU12V05-US Power Adapter 12v 0.5A US
- OPT1-PSU12V05-EU Power Adapter 12v 0.5A Europe
- OPT1-PSU12V05-UK Power Adapter 12v 0.5A UK

The following figure depicts a typical power adapter. The figure also describes the labels for the electrodes.

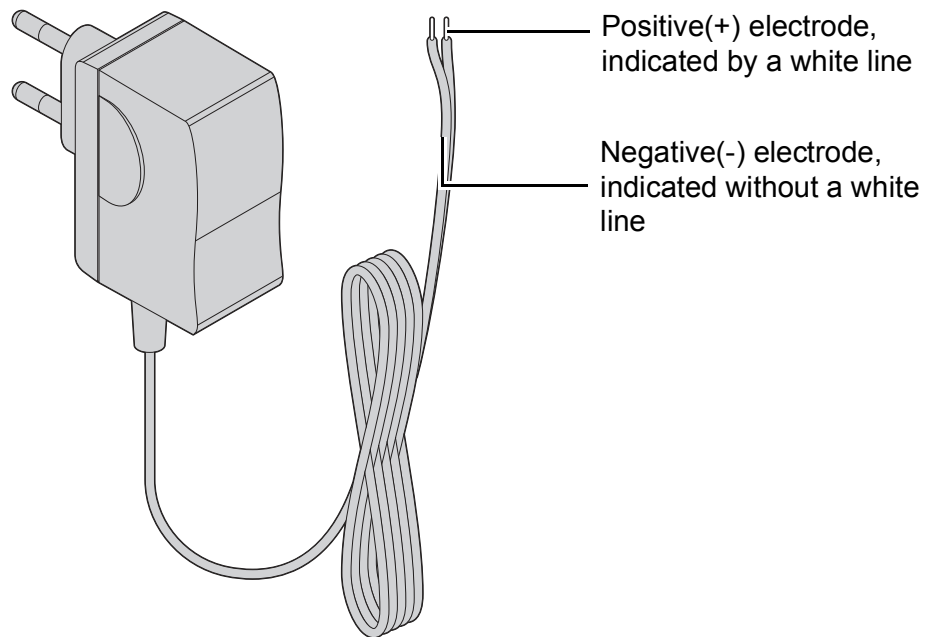

Figure 2.15 Power Adapter Electrode Label Indication

2.3.4 Serial Connection

EKI-1511 Series provides a single DB9 (male) connector. RS-232 pin assignments are illustrated as follows:

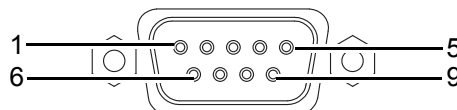

Figure 2.16 DB9 Pin Assignment

Pin	1	2	3	4	5	6	7	8	9
RS-232	-	RX	TX	-	GND	-	RTS	CTS	-

EKI-1511X Series provides a single RS-422/485 connector. The RS-422/485 pin assignments are illustrated as follows:

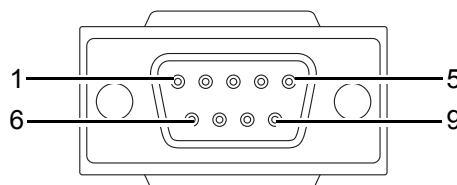

Figure 2.17 RS-422/485 Pin Assignment

Pin	1	2	3	4	5	6	7	8	9
RS-422 (RS-485-4W)	TX-			TX+	GND		RX+		RX-
RS-485	DATA-			DATA+	GND				

2.3.5 Power Connection

2.3.5.1 Overview

Warning! Power down and disconnect the power cord before servicing or wiring the serial device server.



Caution! Do not disconnect modules or cabling unless the power is first switched off.



The device only supports the voltage outlined in the type plate. Do not use any other power components except those specifically designated for the serial device server.

Caution! Disconnect the power cord before installation or cable wiring.



1. Insert the power wire from DC power supply into the power contacts of the terminal lock connector on the EKI device.
2. Tighten the terminal screws to prevent the DC wires coming loose.
3. Switch on the DC power supply.

If the EKI-1511 Series is working properly, the blue power LED will light up, indicating that the EKI-1511 Series is receiving power.

The EKI-1511 Series supports dual 9 to 36 V_{DC} power inputs and power-fail relay output.

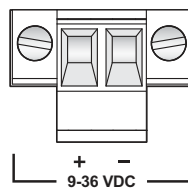

Figure 2.18 Power Wiring for EKI-1511 Series

Chapter 3

Utility Configuration

3.1 Installing the Configuration Utility

Note! *Microsoft.NET Framework version 2.0 or greater is required for this application.*



1. Insert the Advantech EKI Device Configuration Utility CD-ROM into the CD-ROM drive (whereas E:\ is the drive name of your CD-ROM) on the host PC.
2. Use Windows explorer or the Windows Run command to execute the setup program.
3. If there is an existing COM port mapping utility on the host PC, remove it at this time. A system reboot may be necessary before continuing the installation.
4. Once the InstallShield Wizard screen displays, click **Next** to proceed with the installation.

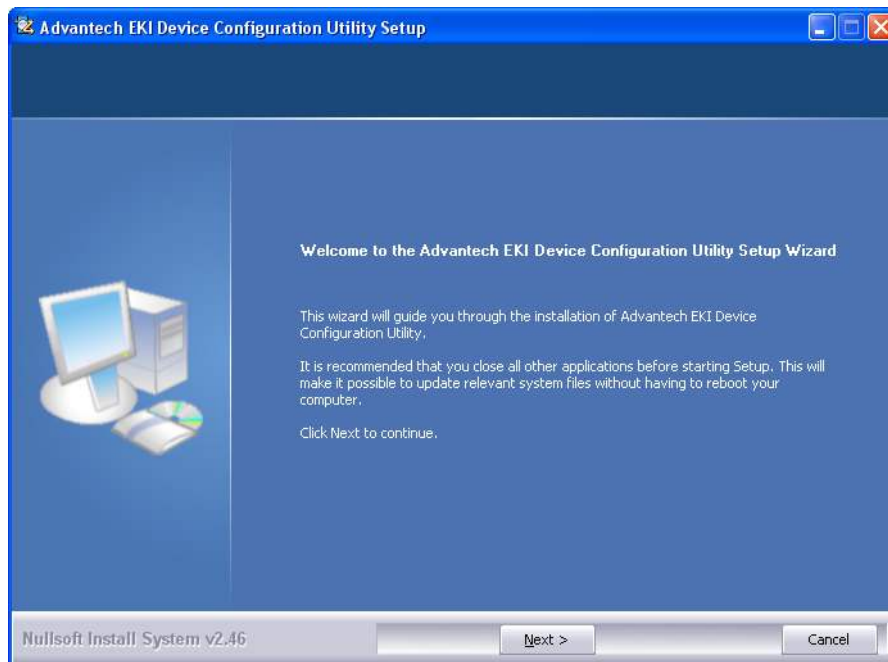

Figure 3.1 InstallShield Wizard 1 of 4

5. The Software License Agreement displays, press **I Agree** to continue or **Cancel** to stop the installation.

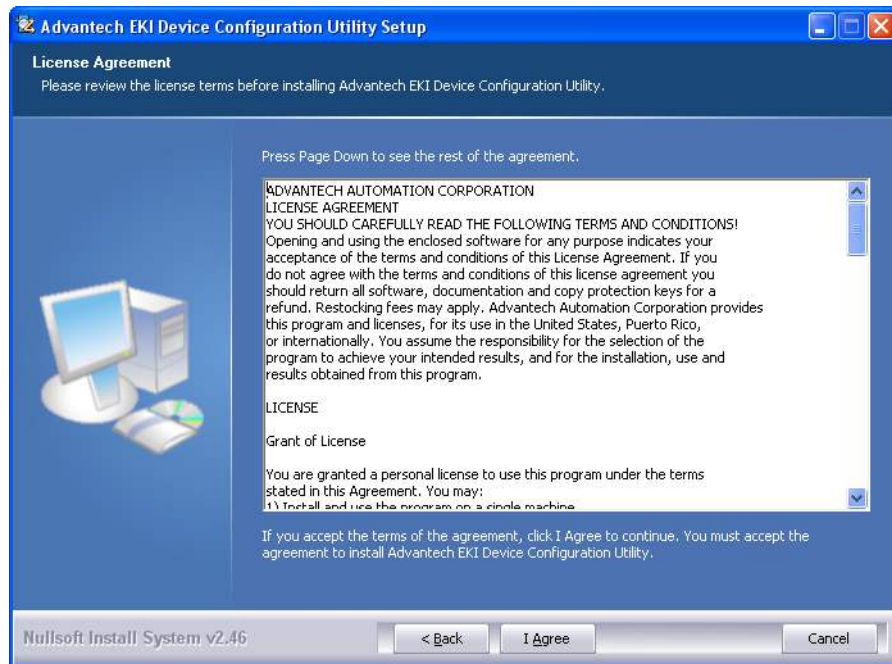

Figure 3.2 InstallShield Wizard 2 of 4

The InstallShield continues and a status screen displays. The default installation path is C:\Program Files\EKI Device Configuration Utility.

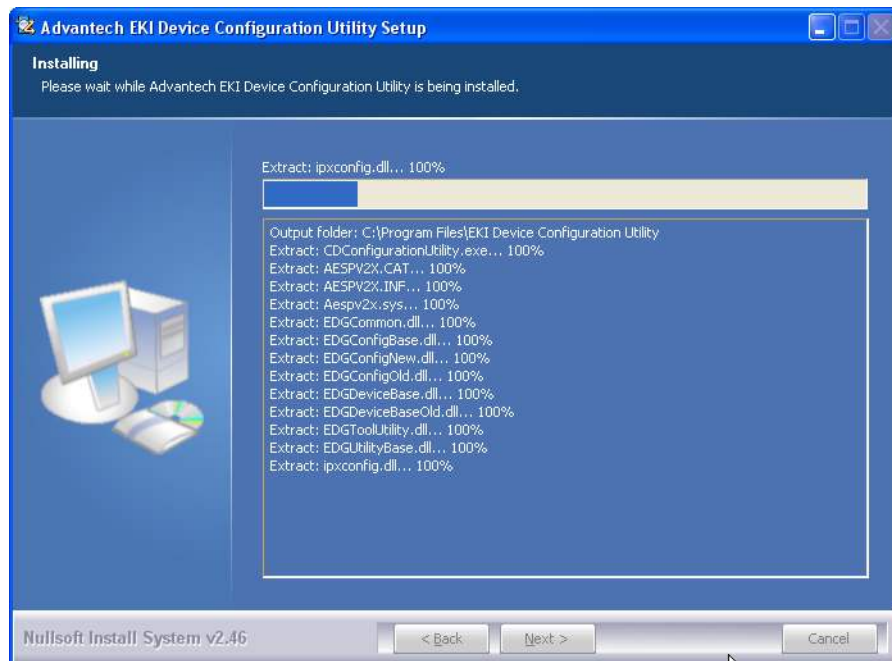

Figure 3.3 InstallShield Wizard 3 of 4

6. Once the installation of the package is finished a Configuration Utility Setup screen displays. Click **Finish** to conclude the process and exit the InstallShield Wizard.

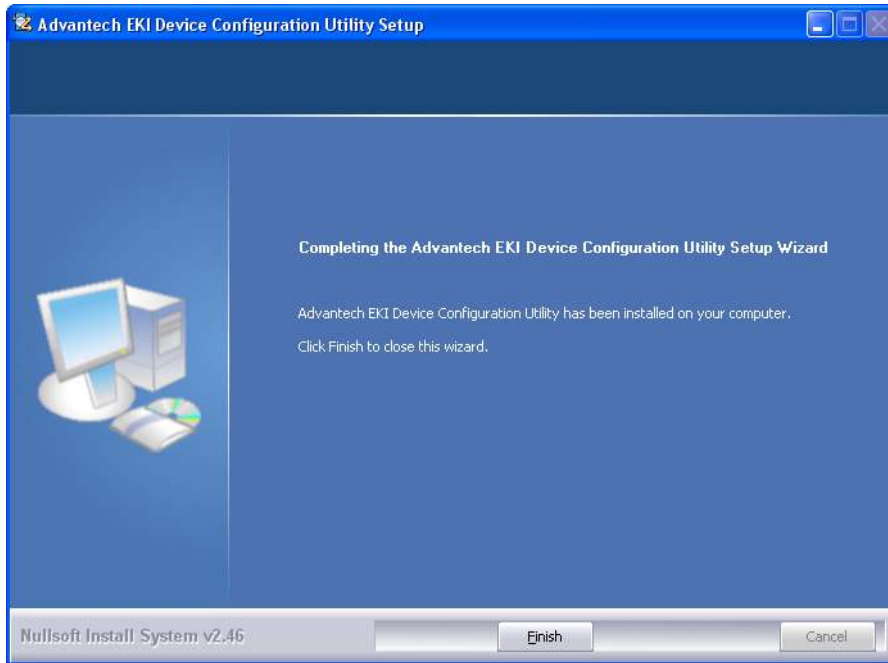

Figure 3.4 InstallShield Wizard 4 of 4

3.2 Starting the Configuration Utility

Advantech EKI-1511 Series device servers provide an easy-to-use utility to configure your serial device server through an Ethernet connection. For secure administration, it can also restrict the access rights for configuration to only one host PC. With this secure function enabled, other PCs will not have permission for configuration. After the installation program on the Advantech IEDG Series Driver Utility CD-ROM is finished, the serial device servers are ready for use and configuration.

Advantech Serial Device Server Configuration Utility is an excellent device server management tool. You can connect and configure the local and remote Advantech serial device servers easily. The utility provides access to the following functions:

- Configure the network settings (you can set the IP address, Gateway address, and Subnet mask)
- View and set the serial port parameters (configure operating mode, baud rate, serial port settings and operating mode settings)
- Perform diagnostic tests (virtual COM port testing, port status list)
- Perform administrative functions (export and import the serial device server setting, manage access IP, a descriptive name, upgrade firmware)

You can open the Configuration Utility from the Windows Start Menu by clicking **Start > All Programs > EKI Device Configuration Utility > EKI Device Configuration Utility**. The Configuration Utility displays as shown in the following figure.

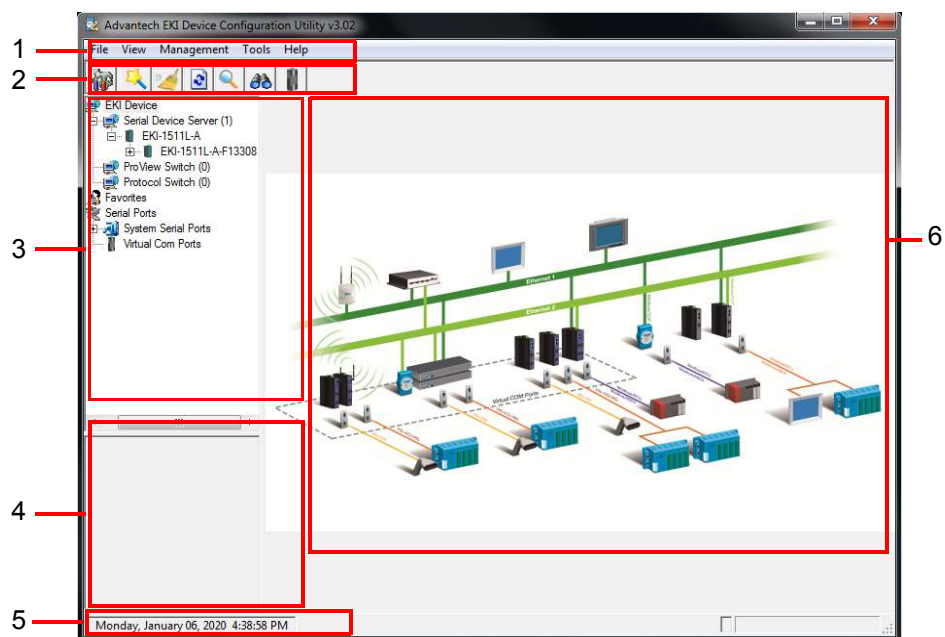

Figure 3.5 Configuration Utility Overview

No	Item	Description
1	Menu Bar	Displays File, View, Management, Tools and Help.
2	Quick Tool Bar	Useful management functions shortcuts.
3	Serial Device Server List Area	Available devices are listed in this area. Devices and COM ports can be organized or grouped in this area.
4	Information Panel	Click on the devices or move cursor to the devices, the related information is shown in this area.
5	Status Bar	Displays the current time.
6	Configuration Area	Click on the item on the Device Server List Area, the configuration page displays.

3.3 Discovering Your Device Server

3.3.1 Auto Searching

Advantech Serial Device Server Configuration Utility will automatically search all the EKI-1511 Series device servers on the network and show them on the Serial Device Server List Area of the utility. The utility provides an auto-search function to show your device (s) by simply executing the configuration utility program from the Start Menu.

From here all device on the same network domain will be searched and displayed on Device Server List Area. You can click on the device name to show the features of the specific device.

Click on the “+” before the model name, and the utility will expand the tree structure to show the individual device name. Click on the “-” before the model name, and the utility will collapse the tree structure.

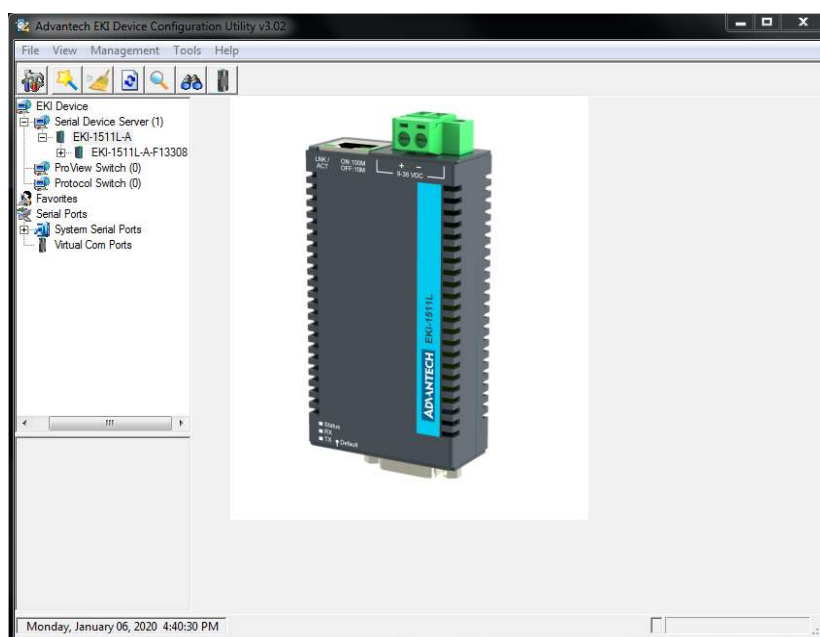

Figure 3.6 Open View of Serial Device Configuration Utility

Note! *When you run the configuration utility for the first time, the default device name is obtained from the serial device's MAC identification number. The name can be altered through the configuration utility.*

Select the device in this sub-tree. The first tab on the Configuration Area shows the summary of “Basic Information” included device type, version, and name, “Ethernet

Information”, and “Serial Port Information”. The serial port information frame displays the operation mode, status and connected host IP.



Figure 3.7 Selecting a Group

Click on the “+” before the device name, and the utility will expand the interfaces on this device server.



Figure 3.8 Selecting a Device

Click on each item to enter the configuration page to change the setting. The configuration will be introduced on following sections.

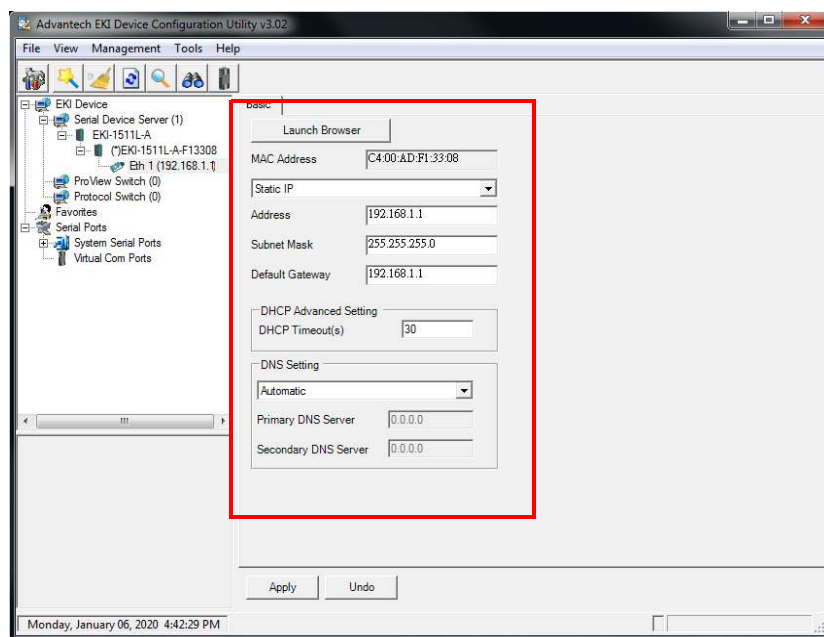

Figure 3.9 Viewing Basic Settings

3.3.2 Network Settings

Prior to setting up the server's IP address determine the IP address mode.

There are four mode types available:

- Static IP: mode to assign a specific assigned address
- DHCP / AutoIP: mode to automatically assign IP addresses through a DHCP server
- BOOTP / AutoIP: mode to automatically assign an IP address through the configuration server
- DHCP/BOOTP/AutoIP: mode to automatically assign an IP address using a Bootstrap Protocol or DHCP server.

The server is set with the following default IP configuration:

- 10.0.0.1 (Eth1)

The EKI-1511 Series includes a software utility option, which you can install on your system, for configuration through computer-based software. The EKI-1511 Series also includes a web interface option for configuration through a standard web browser.

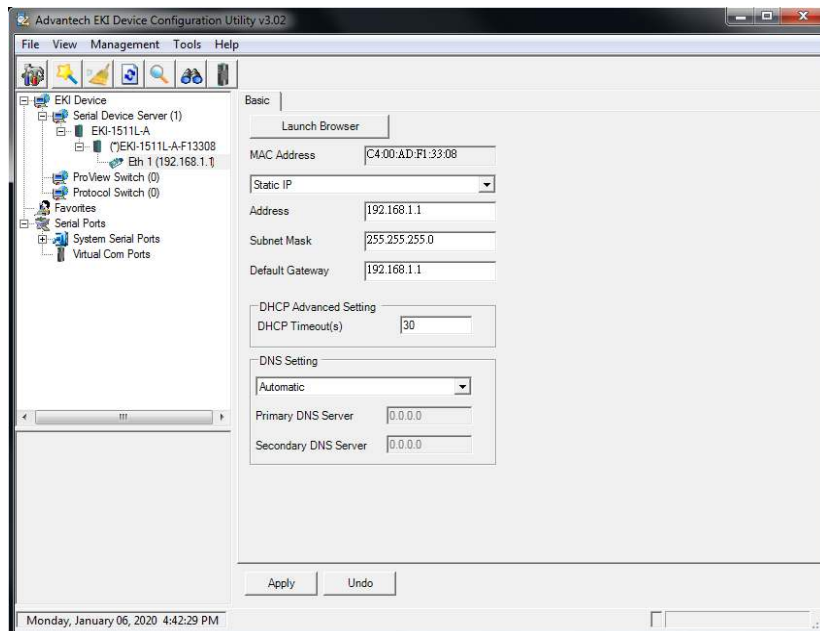



Figure 3.10 Utility Overview

You can choose from four possible IP Configuration modes --- Static, DHCP, BOOTP, and DHCP/BOOTP.

Figure 3.11 Network Settings Overview

Item	Description
Static IP	Static IP User defined IP address, Subnet Mask, and Default Gateway.
DHCP + Auto-IP	DHCP Server assigned IP address, Subnet Mask, Default Gateway, and DNS.
BOOTP + Auto-IP	BOOTP Server assigned IP address.
DHCP + BOOTP + Auto-IP	DHCP Server assigned IP address, Subnet Mask, Default Gateway, and DNS, or BOOTP Server assigned IP address. (If the DHCP Server does not respond)
DNS Setting	In order to use DNS feature, you need to set the IP address of the DNS server to be able to access the host with the domain name. The EKI-1511 Series device server provides Primary DNS Server and Secondary DNS Server configuration items to set the IP address of the DNS server. Secondary DNS Server is included for use when Primary DNS server is unavailable.
DHCP Advanced Setting	When you enabling DHCP protocol to get IP address, it will be waited DHCP server to give IP within DHCP time out. The default value is 30 seconds.

Note!  When you have finished the configuration of these settings for each category, please press the "Apply" button in order to make these settings effective on the Serial Device Server.

3.4 Administrator Settings

3.4.1 Locate the Serial Device Server

When several serial device servers are connected to the network, identification of a specific serial device is possible through the Locate function.

To locate the serial device server:

1. From the device list frame, locate the desired device and right-click on it to display the settings menu.
2. Select **Locate** from the menu.

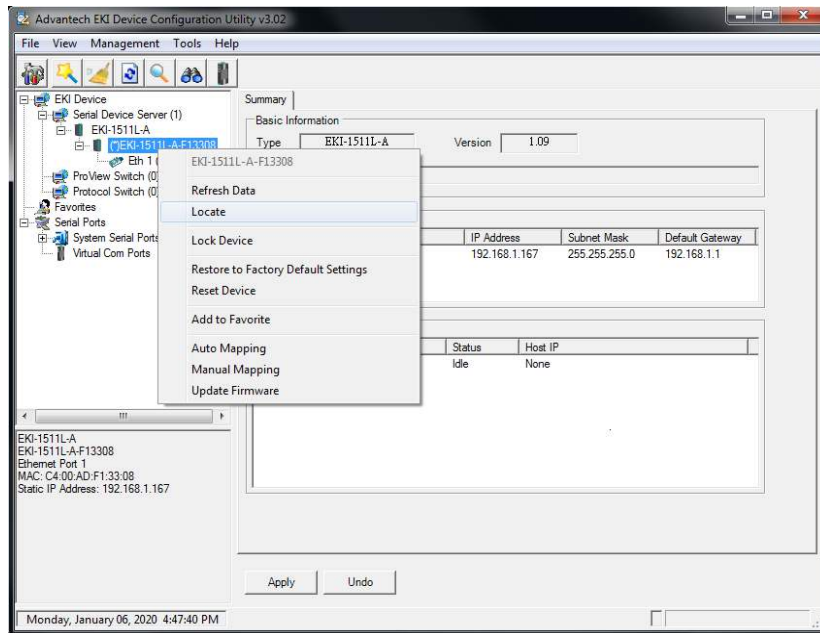

Figure 3.12 Locate the Serial Device Server

The unit's Status LED lights solid blue until you click **Stop Locate**.

3.4.2 Securing the Serial Device Server

3.4.2.1 Lock the Serial Device Server

The configuration utility provides the “Lock Device” function to make it more secure. To lock the serial device server:

1. Right-click a desired device to display the settings menu.
2. Select **Lock Device**.

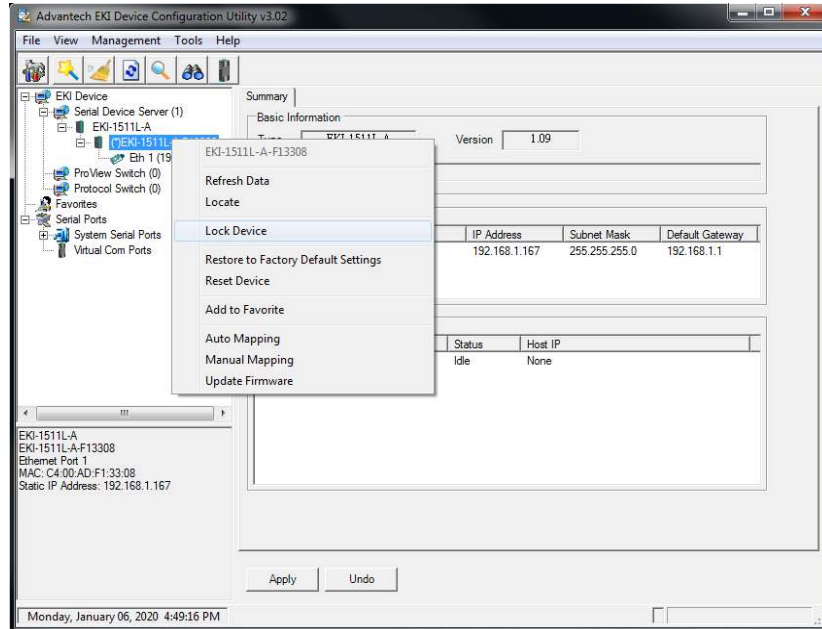

Figure 3.13 Lock the Serial Device Server

3. Enter a password. Retype the password entry to confirm the profile password.

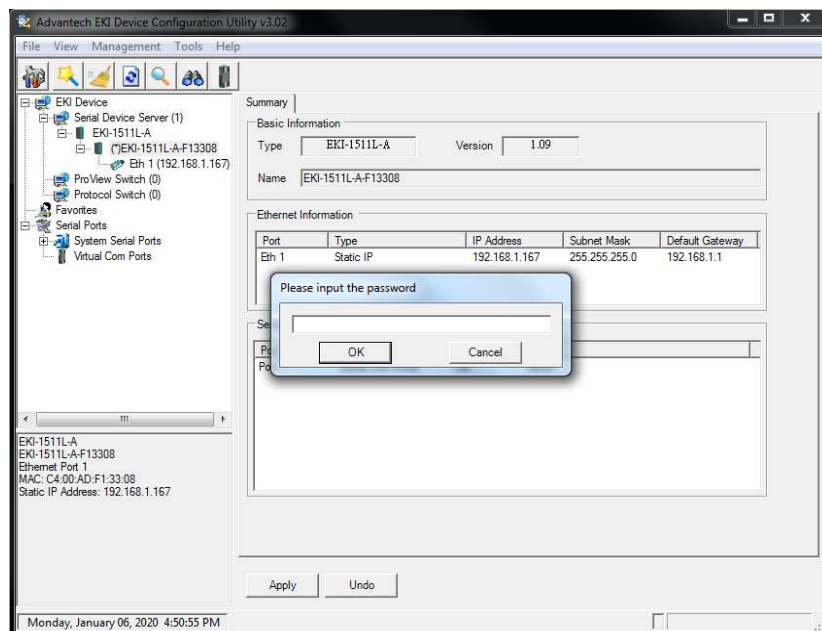

Figure 3.14 Enter a Password

4. Right-click a desired device to display the settings menu. Select **Reset Device** to restart the serial device server and store your setting password into the memory.

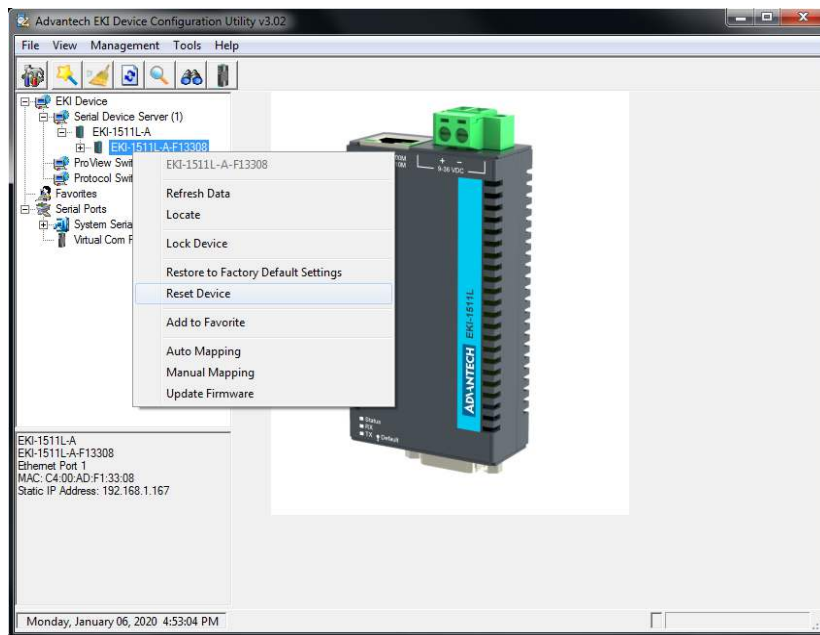

Figure 3.15 Reset Device

3.4.2.2 Unlock the Serial Device Server

To unlock the serial device server:

1. Right-click a desired device to display the settings menu.
2. Select **Unlock Device**.
3. Enter the password as entered in the Lock Device procedure.

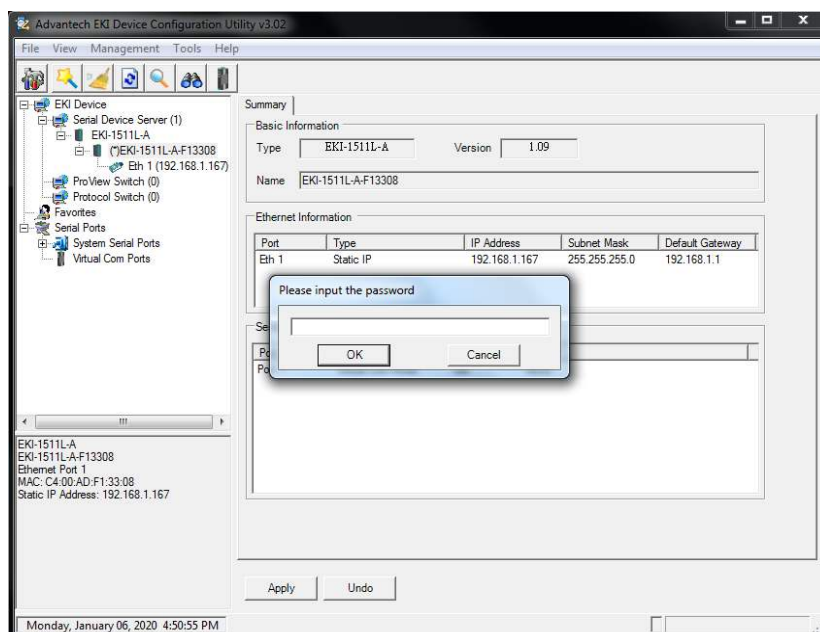

Figure 3.16 Unlock the Serial Device Server

If you forgot the password, you must restore the setting of the serial device server to the factory defaults, which will be introduced in the next section.

3.4.3 Restore to Factory Default Settings

The configuration utility provides the function to restore the serial device server to factory default settings.

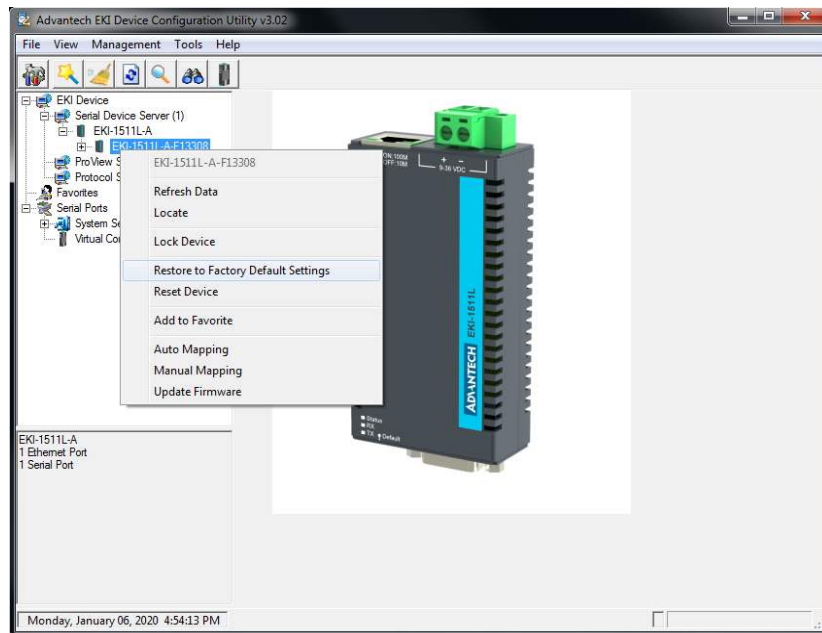

Figure 3.17 Restore to Factory Default Settings

The confirm message will display after clicking **Restore to Factory Default Settings**. If you really want to restore the serial device server to factory default settings, please click **Yes** button to continue.

Power off the serial device server within ten seconds. After reconnecting the power, all settings will be reset to the factory default. If the power supply remains connected for more than ten seconds, the serial device server will not be changed.

3.4.4 Resetting the Device

The **Reset Device** is available to allow you to reset the serial device server. The function disconnects both the ethernet and serial connections.

The function also allows the serial device server to save new configuration settings to flash memory. Once a new setting is changed, you can use the Save function to accept the changes. You will need to reset the device to save the settings to flash memory.

To reset the device:

1. Right-click a desired device to display the settings menu.
2. Select **Reset Device**.

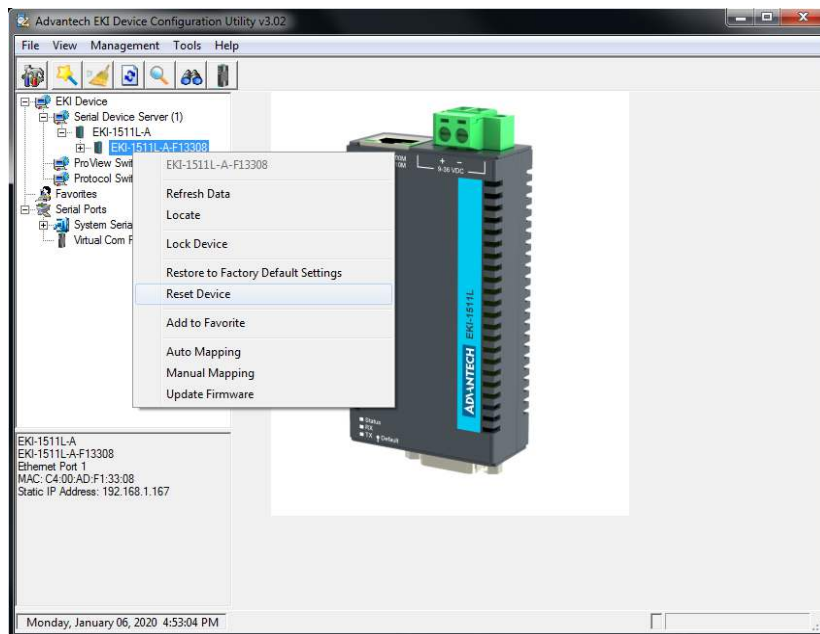

Figure 3.18 Reset Device

The device resets. Once the process is complete, the serial device server displays under the Serial Device Server listing once again.

3.4.5 Add to Favorite

The Add to Favorite function allows to easily map available devices to Favorite's. By bookmarking specific devices, you can create quickly accessible shortcuts for existing critical devices from the vast pool of locally or remotely networked EKI-1511 Series devices.

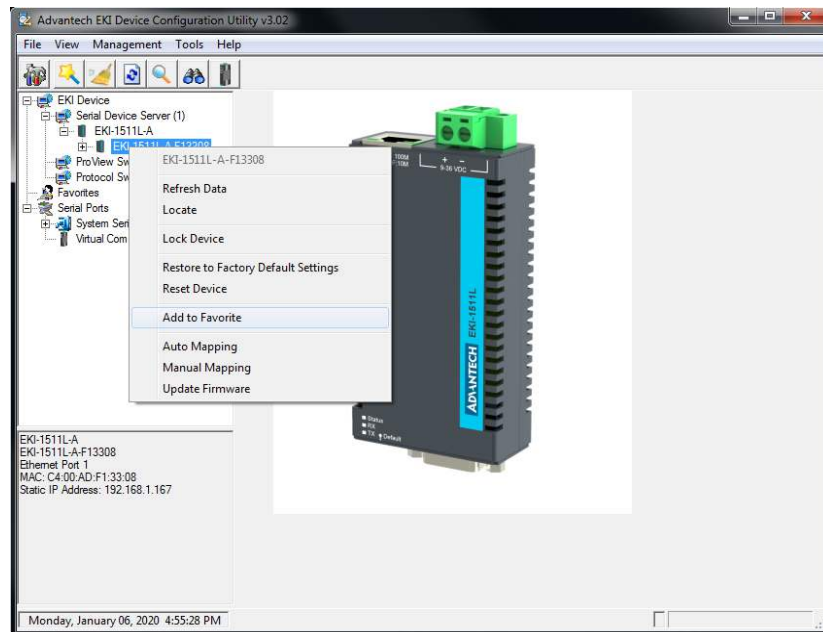

Figure 3.19 Add to Favorite

3.4.6 Auto Mapping

See “Auto Mapping” on page 42 for further details.

3.4.7 Manual Mapping

See “Manual Mapping” on page 44 for further details.

3.4.8 Update Firmware

Advantech continually upgrades its firmware to keep up with the ever-expanding world of computing. You can use the update firmware function in the utility to carry out the upgrade procedure. Please access Advantech's website: <http://www.advantech.com> to download the latest version of the firmware. Before updating the firmware, make sure that your host's Network domain is as same as the serial device server or the host can establish the TCP connection to the serial device server.

To update firmware:

1. Right-click a desired device to display the settings menu.
2. Select **Update Firmware**.

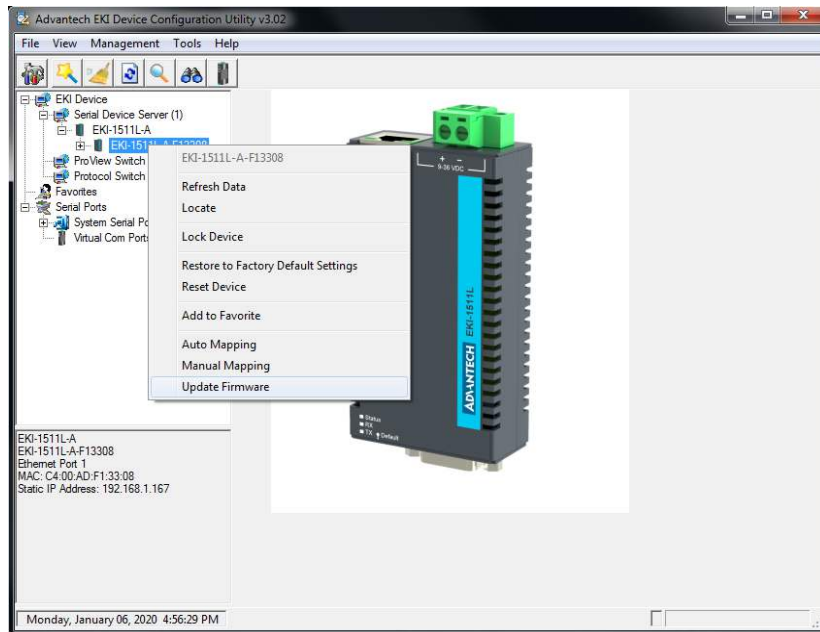

Figure 3.20 Update Firmware

3. Select the firmware file you want to update.

Wait for a few seconds for the firmware to finish updating. After the update has completed, click on the **OK** button. The serial device server will restart automatically.

Note! *Be sure that the host PC Ethernet network domain is as same as the EKI-1511 Series serial device server or the host PC can establish the TCP connection with the serial device server while doing the updating firmware process.*



Chapter 4

Selecting An
Operating Mode

4.1 Overview

The EKI-1511 Series is designed to network-enable any RS-232/422/485 serial device, and provides industry-grade hardware and easy-to-use software to make connecting serial devices to an Ethernet network a surprisingly simple process.

These units immediately upgrade your existing serial devices for integration into the Internet world. The EKI-1511 Series features many powerful functions, such as high speed data transfer, access-control, auto-detection of all EKI-1511 Series products, and more.

After the simple installation steps to attach your network and serial device to the appropriate connectors on the serial device servers and driver installation, you will be able to communicate with the serial devices via its own application software and with the EKI-1511 Series device server. COM port redirector, USDG TCP server mode, TCP client mode, UDP server mode, UDP client mode, RFC2217 mode are all different methods of making a serial connection across using one or more serial device servers.

4.2 COM Port Redirector (Virtual COM Port)

Advantech EKI Device Configuration Utility is a serial COM port redirector that creates virtual COM ports and provides access to serial device connected to Advantech serial device server. You can configure the serial device server and enable the Virtual COM port using one integrated utility. Advantech EKI Device Configuration Utility allows you to configure Microsoft applications to communicate with network enabled serial device servers as easily as if they were physically installed in or directly connected on the PC.

The Advantech redirector can create up to 255 virtual COM ports. Application to the host can open a virtual COM port to access the serial device servers at the same time. The redirector will handle each active virtual COM port as a separate TCP connection to Advantech serial device servers.

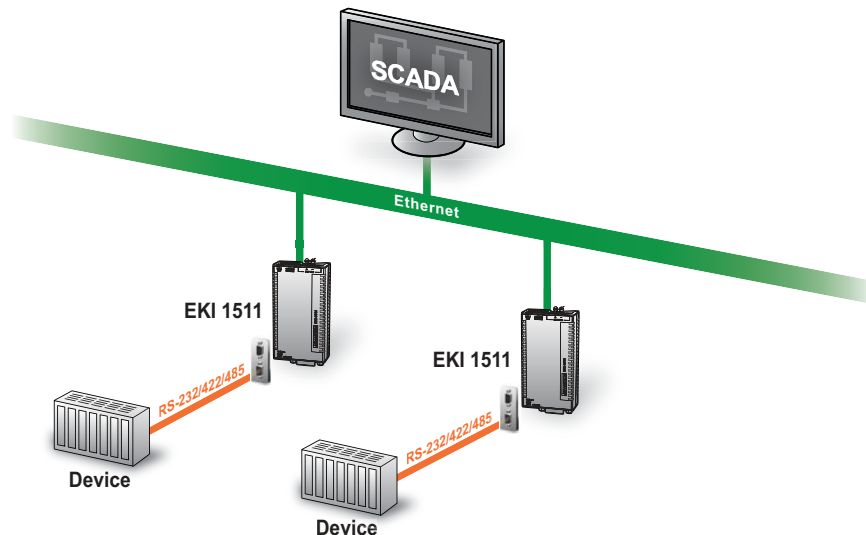

Figure 4.1 Virtual COM Mode

The EKI-1511 Series provides Multi-access function through an Ethernet connection path, allowing a maximum of five connections to open one serial port simultaneously. In this mode all connections must use the same serial setting. If one serial setting within this configuration is configured differently, the data communication will not function correctly.

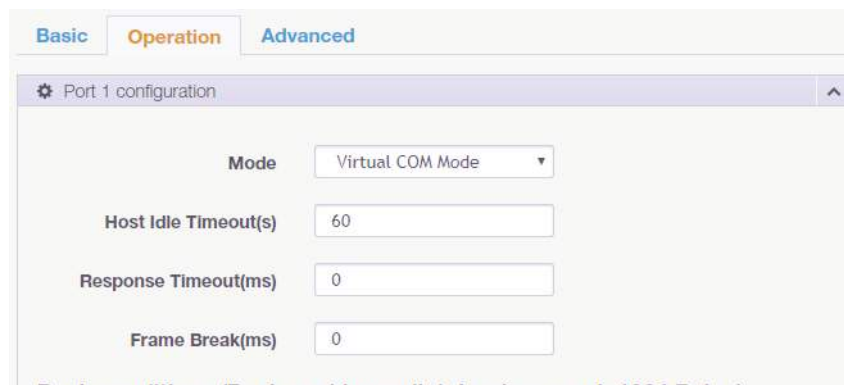

Figure 4.2 Configuring Virtual COM Mode

The Host Idle Timeout setting monitors the connection between the host and the device. If the Host Idle Timeout setting time is reached, the device server will release the resources allocated to the port mapping. This prevents a stalled host from affecting the connective device.

The Multi-access function has two modes. One is **Normal mode** and the other is **Round-Robin mode**.

4.2.1 Normal mode

By disabling the Response Timeout parameter, the EKI-1511 Series will operate in normal mode. When multiple hosts simultaneously open the serial port, only the first connected host obtain management control, the remaining connections only have data communication function. Each serial port supports up to five simultaneous connections, so multiple hosts can transmit/receive data to/from the same serial port simultaneously. Every host can transmit data to the same serial port, and the EKI-1511 Series will also transmit data to every hosts. When the multiple hosts transmit data to the same serial port at the same time, the received data from Ethernet and the outputs of serial port are mixed. When the EKI-1511 Series receives data from serial port, the data will also be transmitted to the connected hosts simultaneously.

4.2.2 Round-Robin mode

By enabling the **Response Timeout** parameter, the EKI-1511 Series Series operates in “Round-Robin mode”. Each serial port supports up to five simultaneous connections allowing hosts to simultaneously transmit/receive data to/from the same serial port. Every host can simultaneously transmit data to the same serial port, EKI-1511 Series processes the data in the order arrived. The EKI-1511 Series processes the first host’s request and replies. The serial device server determines the end of the serial acknowledgment through a response timeout. When EKI-1511 Series serial device server does not receive a response from the serial port after a response timeout query, the device replies with an acknowledgment and then processes the next host request. With an increased number of hosts, response time may be lengthy, increasing the period of the Response Timeout.

Frame Break is an important parameter for Round Robin mode. The parameter is a smart method of reducing ineffective waiting periods and streamlining the transmission process.

If the **Frame Break** function is disabled, EKI-1511 Series devices will wait for a “Response Timeout” period, whether or not the device has transmitted data. During this period, the host commands are queued and processed in the order received.

If Frame Break is enabled, the serial port idle is longer than the Frame Break period. The EKI-1511 Series assumes the communication is completed and continues with the next query. This is an efficient way to reduce waiting time and improve performance.

4.3 USDG Data Mode

The EKI-1511 Series can function as either a Data TCP server or a Data TCP client. Both operations support TCP and UDP protocol. The EKI-1511 Series allows you to treat your serial devices as if they were networking devices. You can issue commands or transmit data from serial devices, connected to a EKI-1511 Series device, to any devices that are connected to the Internet.

4.3.1 USDG TCP Client Mode

In TCP Client mode, the TCP connection is established from the EKI-1511 Series device server. This operation mode supports a maximum of 16 simultaneous connections for each serial port on EKI-1511 Series to one host or several hosts. You can configure the IP address and TCP port number of the network hosts connected to the EKI-1511 Series device server using the Advantech Serial Device Server Configuration Utility. After configuring the devices, when the EKI-1511 Series device server receives the data from the serial port, and the device server connects to the hosts which are configured.

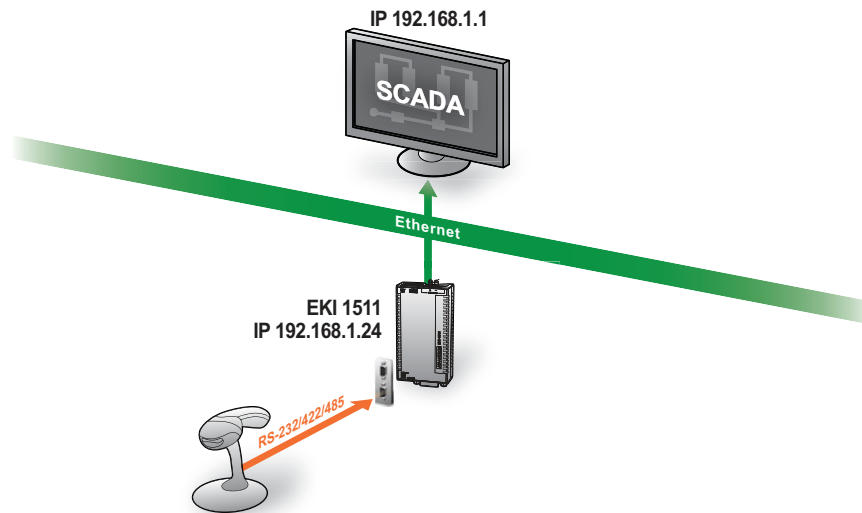

Figure 4.3 USDG TCP Client Mode

In USDG Data TCP Client mode, you may need to enable the peer numbers you would like to receive. You can set a maximum sixteen network devices to which you may connect. You need to fill out the IP Address and Port (including local port and peer port) of each network device to which you want to connect.

In the Peer for Receiving Data menu, entering “0” as the value for the Local Port will assign a random TCP Port for an EKI-1511 Series device.

The screenshot shows a configuration window titled 'Peer for Receiving Data'. It has a 'Peer Number' dropdown menu set to '0'. Below this is a table with four columns: '#', 'Local Port', 'Peer IP address', and 'Port'. The table is currently empty. At the bottom of the window is a 'Save' button.

Figure 4.4 Peers for Receiving Data

4.3.2 USDG Data TCP Server mode

In TCP server mode, the TCP connection is initiated from the host to the EKI-1511 Series device server. This operation mode supports a maximum of five simultaneous connections for each serial port on an EKI-1511 Series device server from a single or multiple hosts. However a multi-host connection simultaneously transmits the data from a single serial port.

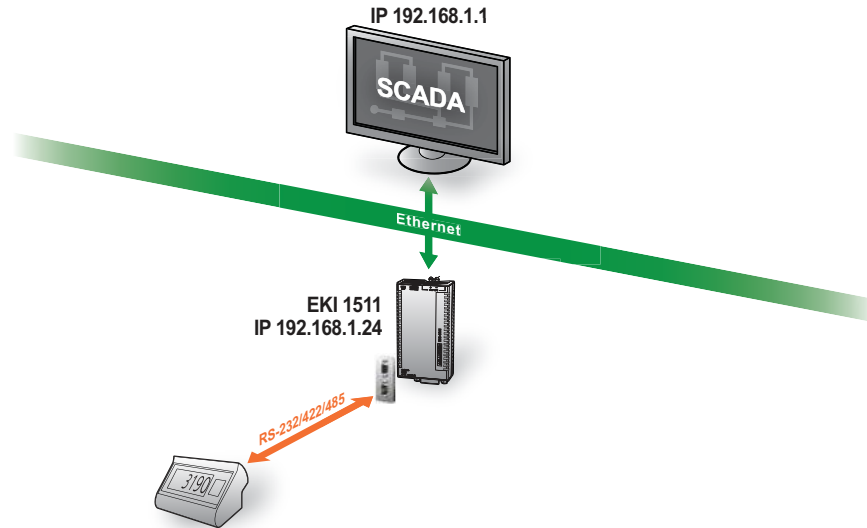

Figure 4.5 USDG TCP Server Mode

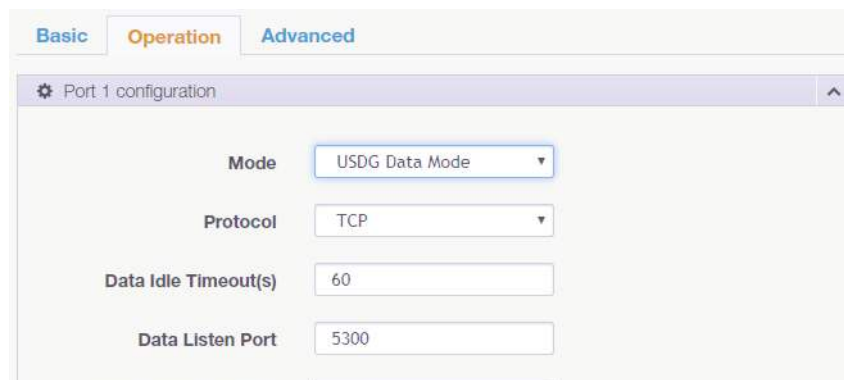

Figure 4.6 USDG Data Mode

4.3.3 USDG UDP Server/Client mode

The USDG UDP mode is primarily used for the broadcasting of messages over a network. In UDP server mode, data is transmitted from the Host connected to the EKI-1511 Series USDG UDP Port (Default Port 5300). In the default UDP client mode, EKI-1511 Series device servers simultaneously transmits UDP messages to a maximum of 16 peers.

USDG Data mode supports Data Idle Timeout, Data Listen Port, and Command Listen Port parameters.

4.3.3.1 Data Idle Timeout

The default is 60 seconds. If you want to keep connection continually, you can disable the Data Idle Timeout. Data idle Time is the time period for which the device waits for data. If the EKI-1511 Series does not receive data during established idle time, the EKI-1511 Series will disconnect temporarily. When the data comes in, it will reconnect automatically. Users do not need to reconnect.

4.3.3.2 Data Listen Port

The TCP/UDP port number represents the source port number, and the number is used to identify the channel for remote initiating connections. The port range is 1024-65533. If an unknown caller wants to connect to the system and request services, they must define the TCP/UDP port to carry a long-term conversation.

Each node on a TCP/IP network has an IP address, and each IP address can allow connection on one or more TCP port. The well-known TCP ports are those that have been defined; for example, port 23 is used for Telnet connections. There are also custom sockets that users and developers define for their specific needs. The default TCP/UDP port of the EKI-1511 Series Port1 is 5300. Users can adjust them according to preference or application. Each port has its own data listen port to accept the connection requests of other network device. The data listen port cannot be set to the same value. You can transmit/receive data to/from devices via the data listen port.

4.3.3.3 Command Listen Port

Each port has its own command listen port to accept connection requests from other network devices, so the command listen port cannot be set to the same value. The Command Listen Port is different from the Data Listen port. <Default Port is 5400>

4.4 USDG Control Mode

In controlling mode, the EKI-1511 Series device server presents a modem interface to the attached serial device: it accepts AT-style modem commands to connect / disconnect to other networking device.

If you want a serial device running application program to connect/disconnect to different devices on request, this function is available through the USDG Control mode.

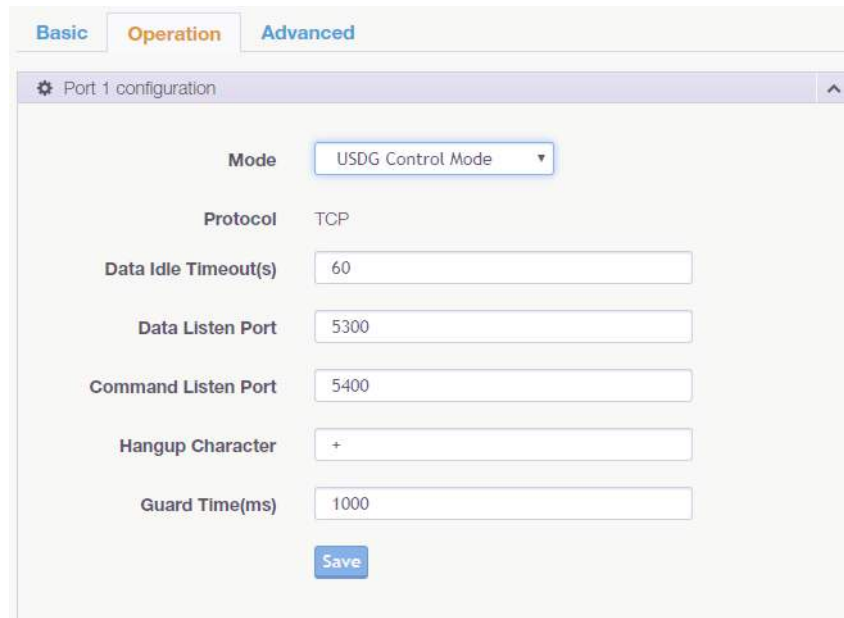

Figure 4.7 USDG Control Mode

4.4.1 Hangup Character

The default character is “+”. After you have connected to another serial device via EKI-1511 Series device, you may need to disconnect, using the command “+++”. To do this, press “+” three times and wait for the Guard timeout <default value is 1000ms>; the device will disconnect. You can set “Guard Time” to define the idle time.

4.4.2 Guard Time

The default value is 1000 ms.

Example: <Guard Time>+++<Guard Time>

Command	Function
ATD <IP address><TCP port><CR>	Forms a TCP connection to the specified host. Ex: ATDT 192.0.55.22:5201 In above example, the EKI-1511 Series device server forms a raw TCP connection to the networking device (192.0.55.22). The TCP port is 5201.
ATA <CR>	Answering an incoming call
+++<CR>	Returns the user to the command prompt when entered from the serial port during a remote host connection.
<LF><CR> OK <LF><CR>	Commands are executed correctly
<LF><CR> CONNECT <LF><CR>	Connect to other device

Command	Function
<LF><CR> RING ddd.ddd.ddd <LF>< CR>	Detect the connection request from other device, which IP address is ddd.ddd.ddd.ddd.
<LF><CR> DISCONNECT <LF><CR>	Disconnect from other device
<LF><CR> ERROR <LF><CR>	Incorrect commands
<LF><CR> FAIL <LF><CR>	If you issue an ATDT command and can not connect to the device, it will response "FAIL".

4.5 RFC2217 Mode

RFC2217 mode is similar to virtual COM mode in that a driver is used to establish a transparent connection between a host computer and a serial device by mapping the serial port on EKI-1511 Series devices to a local COM port on a host computer. RFC2217 defines general COM port control options based on the Telnet protocol. Third party drivers supporting RFC2217 are widely available on the Internet and can be used to implement virtual COM mapping to the serial port of your device.

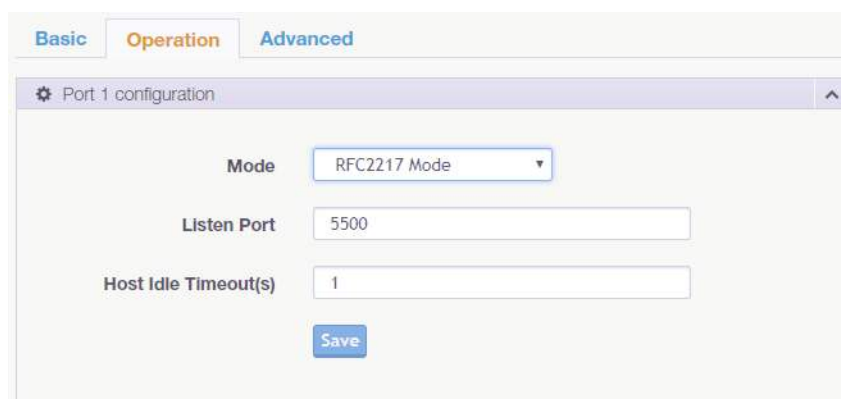

Figure 4.8 RFC2217 Mode

Chapter 5

Setting up Virtual COM
Port

5.1 Setting COM Port Redirector

Advantech COM port mapping software is a serial COM port redirector that creates virtual COM ports and provides access to serial devices connected to an Advantech serial device servers. Your serial device applications can communicate with serial devices connected to the Advantech serial device servers without software changes.

Since the virtual COM ports work like standard Windows COM ports, your application software sees no difference between a local serial device and one connected to an Advantech serial device server.

The COM redirector utility and the virtual COM port management utility are integrated into one utility with same GUI. The Advantech Serial Device Server Configuration Utility can create all Virtual COM ports using the Auto Mapping function or by using the manual mapping function.

5.2 Virtual COM Port Mapping

5.2.1 Auto Mapping

1. On your desktop, navigate to **Start > All Programs > EKI Device Configuration Utility** and click **Advantech EKI Device Configuration Utility** to open the utility.
2. Under Serial Device Servers, locate **your server** and **click the icon to expand the listing**.
3. Select the target device and right-click on it to open up the options menu window.
4. Locate **Auto Mapping** and select it.

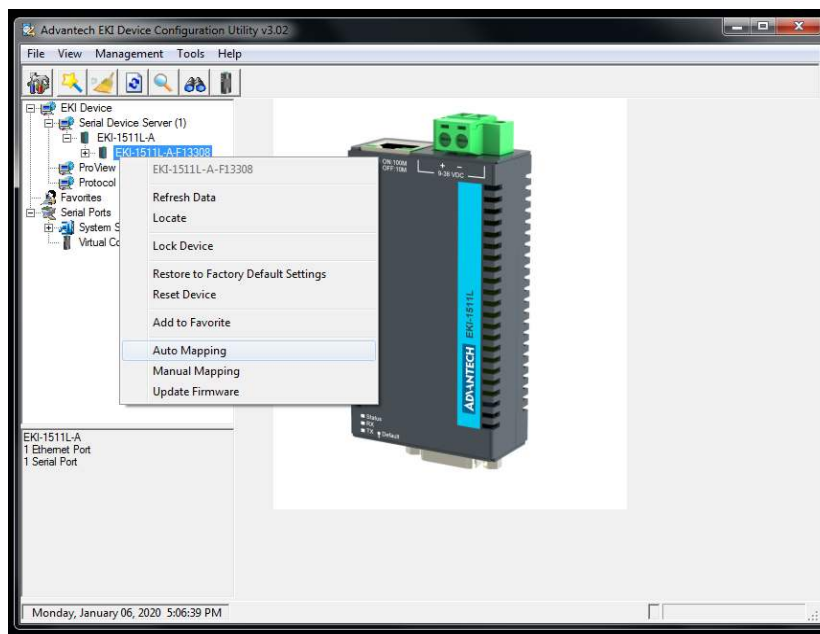

Figure 5.1 Selecting Auto Mapping

The **Batch Automatic Mapping Virtual COM Port** window displays.

5. Locate **From System Port** and click the drop-down menu to select the target COM port.
6. From the network address list, select the address options to map.

The selected address displays the Device Port and (EKI-1511 Series device server physical serial port) and the system port which will be the VCOM port for the PC.

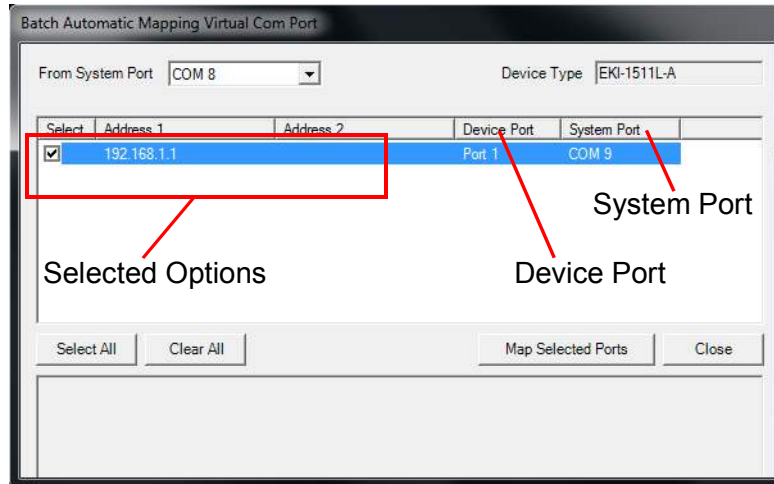

Figure 5.2 Selecting Auto Mapping

7. From the network address list, select the address options to map.
8. Click **Map Selected Ports** to set the configuration.

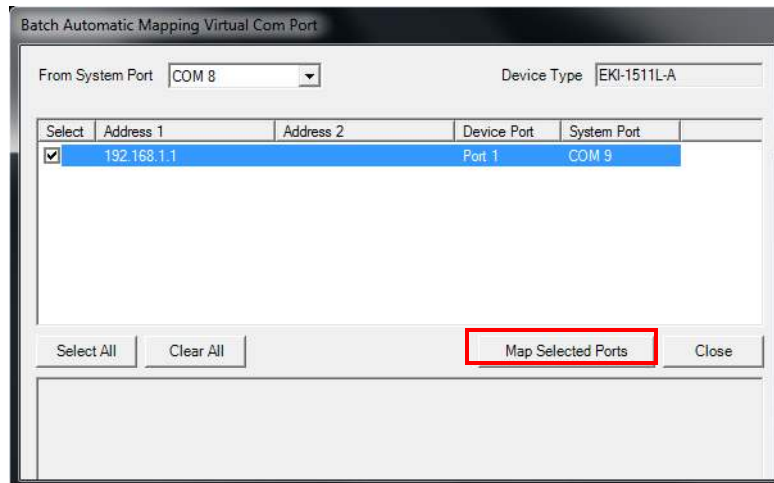

Figure 5.3 Mapping Selected Ports

Once the mapping function is initialized, a successful mapping process results in the virtual mapping of the designated physical serial port and VCOM PC port. See the following figure.

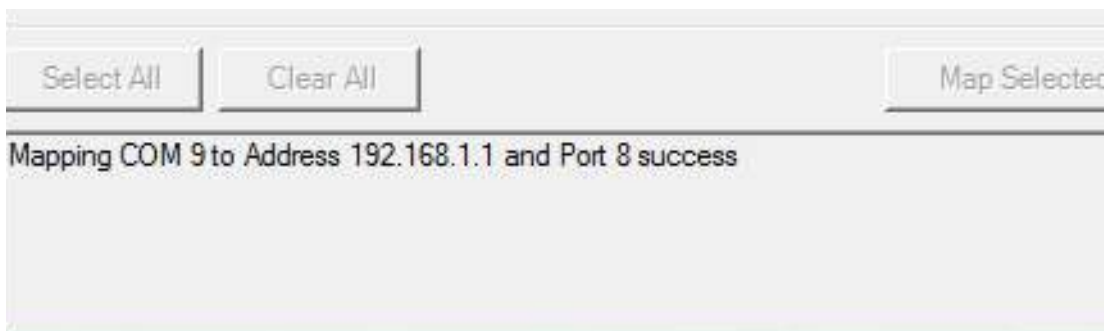

Figure 5.4 Viewing VCOM Mapping Results

5.2.2 Manual Mapping

1. On your desktop, navigate to **Start > All Programs > EKI Device Configuration Utility** and click **Advantech EKI Device Configuration Utility** to open the utility.
2. Under **Serial Device Servers**, locate your server and click the icon to expand the listing.
3. Select the target device and right-click on it to open up the options menu window.
4. Locate **Manual Mapping** and select it.

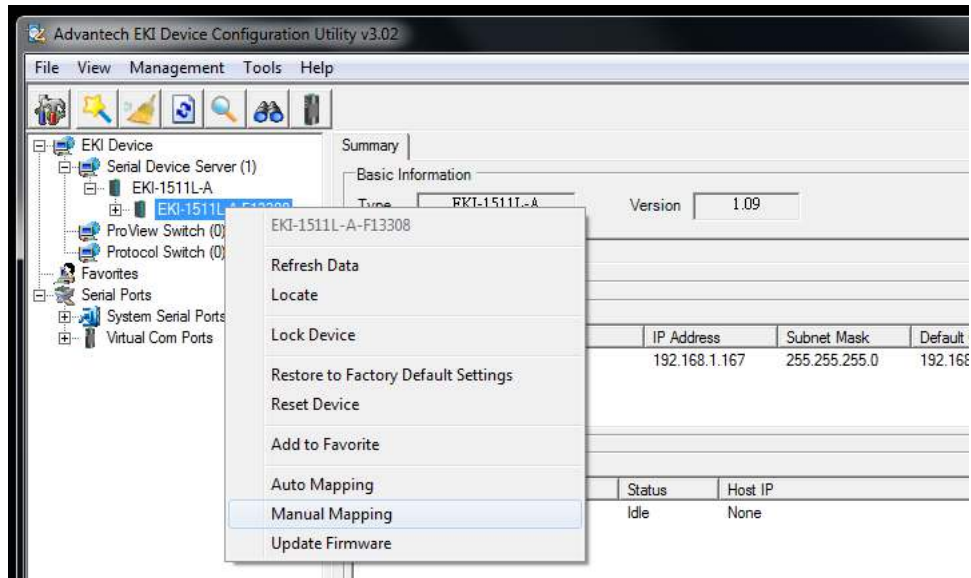

Figure 5.5 Selecting Manual Mapping

The **Manual Mapping Virtual COM Port** window displays.

5. With the EKI-1511 Series, there is only a single port. It is not necessary to select from the Serial Port field.
6. In the **Host > COM Port** drop-down menu, select the target COM port to map. This is the virtual port on the target PC.

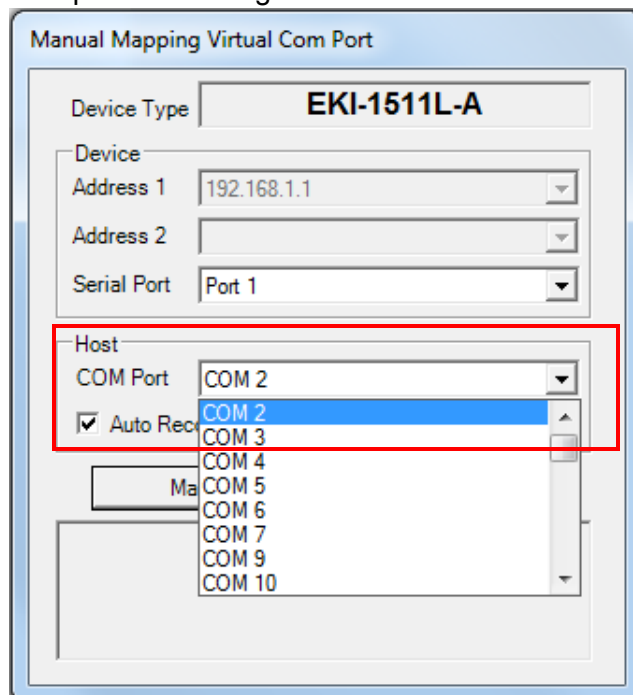

Figure 5.6 Manual Mapping of Host Port

- Click **Map it** to continue the process. The mapping process may require a short time. Once this step is completed, the **Manual Mapping Virtual COM Port** window displays again to map the VCOM port on the target PC. Once the mapping function is initialized, a successful mapping process results in the virtual mapping of the designated physical serial port and VCOM PC port. See the following figure.

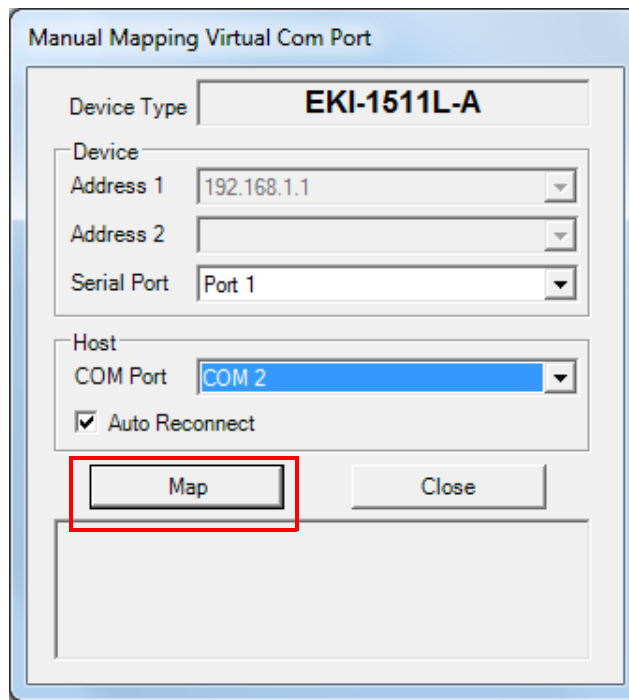

Figure 5.7 Manual Mapping of a Virtual COM Port

To allow for an automatic connection after a reboot or a power up, click the **Auto Reconnect** option to enable this function.

5.2.3 Configuration Wizard

- On your desktop, navigate to **Start > All Programs > EKI Device Configuration Utility** and click **Advantech EKI Device Configuration Utility** to open the utility.
- Under **Serial Device Servers**, locate your server and click the icon to expand the listing.
- From the tool bar, select **Configuration Wizard**.



Figure 5.8 Selecting the Configuration Wizard

The Wizard screen displays and lists available devices.

- Select the target device and click **Next** to continue. The Wizard Device Settings window displays.
- Under Serial Port Settings, click the **Type** drop-down menu and select the port type. Review the settings under the Ethernet fields and verify them.
- Click **Next** to continue or **Previous** to return to the previous screen.

The selected settings are displayed in the following Wizard window.

7. Locate the radio button correlating to the target port to modify and click on it to select it.
Verify the Device Port (EKI-1511 Series device physical serial port) and System Port (virtual COM port for PC) settings before continuing.
8. Click **Finish** to complete the process. A Wizard complete! screen displays indicating the completion of a successful procedure.

5.2.4 Confirming Virtual COM Settings

1. On your desktop, navigate to **Start > All Programs > EKI Device Configuration Utility** and click **Advantech EKI Device Configuration Utility** to open the utility.
2. Locate **Serial Ports** menu in the menu pane and click on the Expand icon next to Virtual COM Ports to view a list of the mapped ports.
3. Select a system serial port to view its settings.

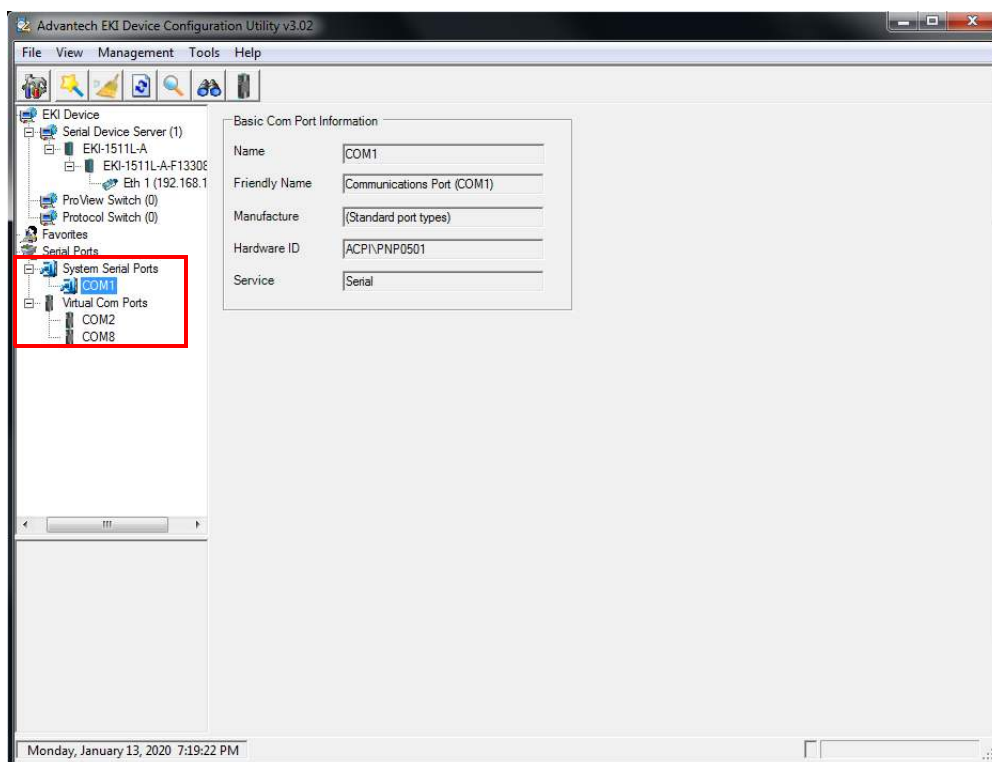

Figure 5.9 Serial Port Listing on EKI-1511 Series Device

For the next step, you will need to open the device manager on your system. Using the Device Manager, you can both view and change the COM port settings.

Note! *The following instructions were developed in a Windows 7 environment; the Windows XP equivalent is displayed in parentheses (). Instructions may vary according to the operating system used.*

4. On your desktop, click on the **Start** button and then on **Control Panel**. A window displays showing all the available control panels.
5. Click on **Hardware and Sound (Hardware)**. A list of all available hardware configuration options displays.

6. Under **Devices and Printers**, click on the **Device Manager** link. A new window displays showing a list of all the available devices on your computer.
7. Locate **Ports (COM & LPT)** and click on the expand icon. A list of all available serial and parallel port devices display. The newly mapped VCOM port should be listed under the same mapped settings used in the previous steps.

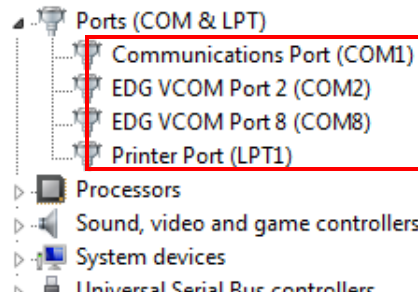

Figure 5.10 System Port VCOM Mapping Configuration

The newly mapped VCOM port is listed under the same mapped settings used in the previous steps. The settings correspond to the VCOM port configuration on the EKI-1511 Series device, see the following figure.

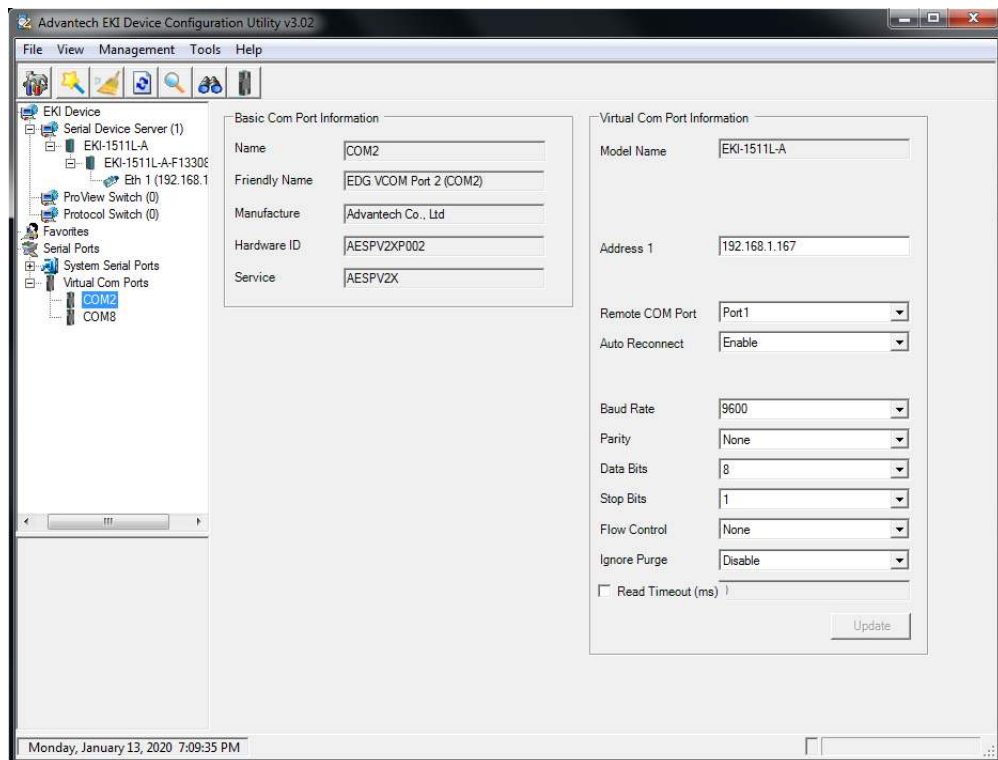

Figure 5.11 Verifying VCOM Mapping Configuration

If the settings do not correspond, the VCOM mapping is not correct. See “Virtual COM Port Mapping” on page 42 to re-map the VCOM ports.

5.2.5 Removing VCOM Ports

1. On your desktop, navigate to **Start > All Programs > EKI Device Configuration Utility** and click **Advantech EKI Device Configuration Utility** to open the utility.
2. Under Serial Ports, click the expand icon on Virtual COM Ports to view the configured port list.
3. Locate the port to remove and right-click on it to open the options menu.
4. Scroll down to **Remove This Port** and click on it to initiate the procedure.

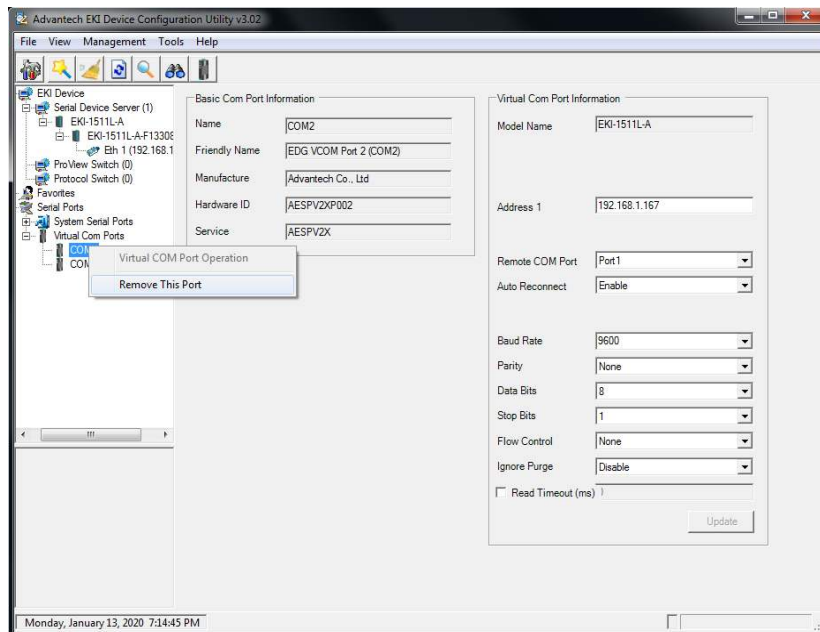

Figure 5.12 Remove VCOM Port

- A Remove Port confirmation window displays.
5. Click **OK** to continue with the removal process or **Cancel** to return to the previous menu.
- Once the procedure is completed, a prompt displays the successful removal of the port from the VCOM mapping list.

5.2.6 Exporting and Importing VCOM Mapping

Importing and exporting Virtual COM Port Mapping is useful when the factory has already used a number of serial device servers in VCOM mode. You can easily upgrade to a new utility, and don't need to re-map the Virtual COM Ports. For example, when you would like to upgrade from Utility 1.71 to Utility 3.0, you can export your own mapped Virtual COM Ports in Utility 1.71 and save them as a *.cpm file.

After upgrading to Utility 3.0, import your *.cpm file and restore your own Virtual COM Ports.

Note! *This Virtual COM Port Mapping tool can only recover Virtual COM Ports that have been mapped previously. For newly installed serial device servers, please follow the virtual COM Port mapping steps.*



1. On your desktop, navigate to **Start > All Programs > EKI Device Configuration Utility** and click **Advantech EKI Device Configuration Utility** to open the utility.
2. Locate **Serial Ports** menu in the menu pane and click on the Expand icon next to Virtual COM Ports to view a list of the mapped ports.
3. Select a VCOM port.
4. Click **Import Virtual COM Port Mapping** or **Export Virtual COM Port Mapping** in the File menu.

5.3 Running a Diagnostic Test

The loopback test allows you to determine if the EKI-1511 Series device server is configured correctly to identify any failed nodes in the network. The test allows you to send a signal from the server and return (looped back) it back to the server.

1. Connect the loopback connector to a COM port on the EKI-1511 Series device server.
2. On your desktop, navigate to **Start > All Programs > EKI Device Configuration Utility** and click **Advantech EKI Device Configuration Utility** to open the utility.
3. Under Serial Ports, click the expand icon on Virtual COM Ports to view the configured port list.
4. Open the ICOMToolsPlus utility to open the EKI-1511 Series device server settings.
5. Set the COM port configuration to match the Port Configuration.
6. Click the **Start** menu.

A successful loopback test incrementally displays the Bytes/sec values on both displayed menus.

Chapter 6

Web Interface

6.1 Overview

EKI-1511 Series serial device server can be configured through a web interface. By using a standard web browser, the same procedure as with the Windows configuration utility can be used. In the browser's address field, enter the IP Address of your EKI-1511 Series serial device server. The default IP setting is 10.0.0.1, but you should use the IP which you have previously assigned for this device. Once the IP is entered, you will be presented with the following windows.

Note! Before using the web-based configuration, make sure your host PC Ethernet network IP domain is as same as the serial device server, or it can establish the TCP connection with the serial device server.



Note! It is recommended that you use Microsoft Internet Explorer 7.0 or higher.



6.2 Accessing the Web Page

6.2.1 Accessing the Web Page via Configuration Utility

To access the web page via configuration utility:

1. Select Ethernet under the desired device.
2. Click **Launch Browser**.

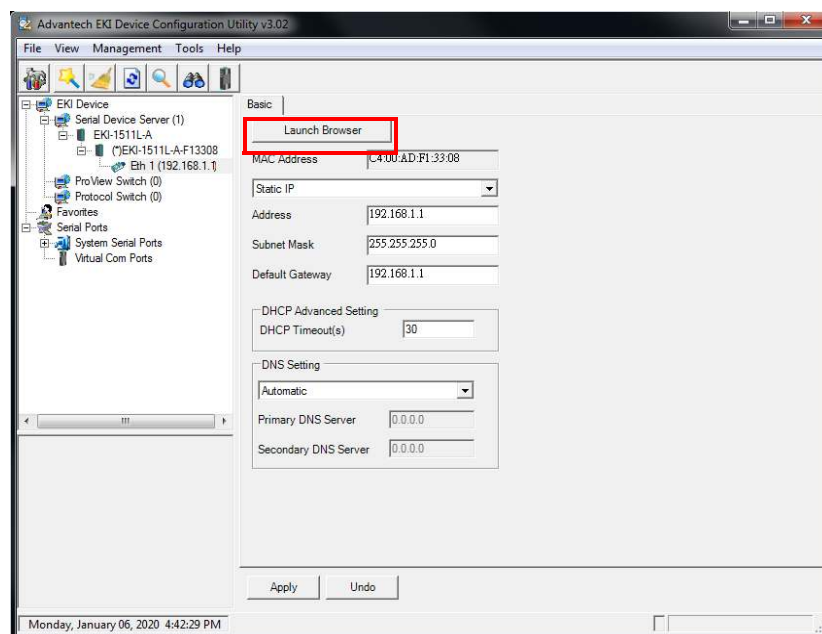

Figure 6.1 Accessing the Web Page via Configuration Utility

6.2.2 Accessing the Web Page via Web Browser

Once the device is installed and connected, power on the device. The following information guides you through the logging in process.

1. Launch your web browser on the PC.
2. In the browser's address bar, type the device's default IP address (Eth1: 10.0.0.1).

The main menu is shown.

6.3 System

You can change the Device Name and Device Description on this page. You can also enable or disable the Telnet and SNMP functions. Moreover, you can set the Time zone related settings.

To access this page, click **System**.

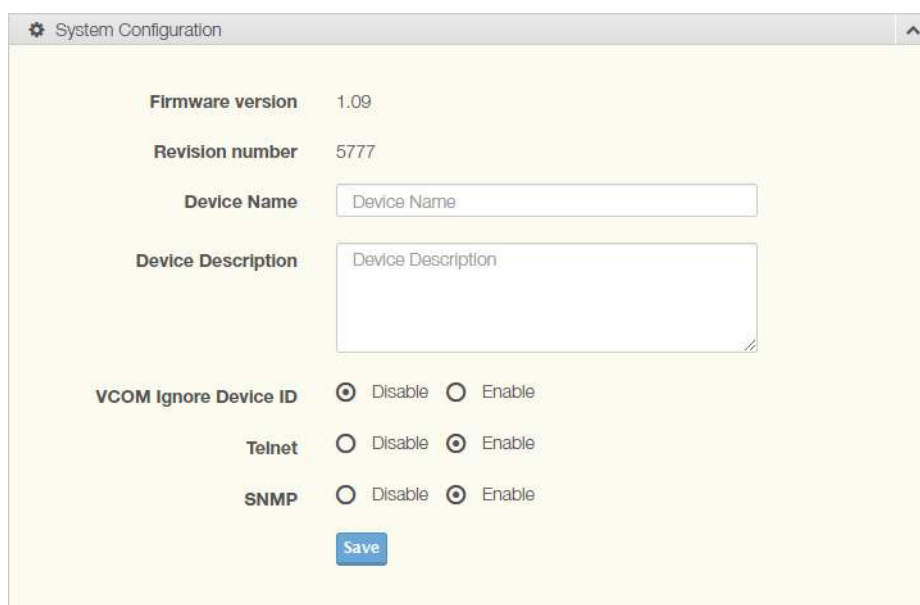

The screenshot shows a web browser window titled "System Configuration". The page has a light yellow background. At the top, it displays "Firmware version 1.09" and "Revision number 5777". Below these are two input fields: "Device Name" and "Device Description". Underneath are three sets of radio buttons: "VCOM Ignore Device ID" with "Disable" selected, "Telnet" with "Enable" selected, and "SNMP" with "Enable" selected. A blue "Save" button is located at the bottom center of the form area.

Figure 6.2 System

The following table describes the items in the previous figure.

Item	Description
Firmware version	Displays the current firmware version of the device.
Revision number	Displays the revision number of the device.
Device Name	Enter the device name: up to 31 alphanumeric characters.
Device Description	Enter the device description.
VCOM Ignore Device ID	Click Enabled or Disabled to enable or disable VCOM ignore device ID.
Telnet	Click Enabled or Disabled to set remote access through the Telnet Service function.
SNMP	Click Enabled or Disabled to define the SNMP daemon.
Save	Click Save to save the values and update the screen.

6.4 Ethernet Configuration

Choose **Eth 1** in the Ethernet Configuration page. Enter the corresponding values for your network environment. Remember press **Save** after fill in all values.

To access this page, click **Ethernet Configuration**.

Figure 6.3 Ethernet Configuration

The following table describes the items in the previous figure.

Item	Description
Mode	Click the drop-down menu to select the IP Address Setting mode: Static or DHCP.
MAC Address	Enter the MAC address to which packets are statically forwarded.
IP Address	Enter a value to specify the IP address of the interface. The default is 192.168.1.1.
Subnet Mask	Enter a value to specify the IP subnet mask for the interface. The default is 255.255.255.0.
Default Gateway	Enter a value to specify the default gateway for the interface. The default is 192.168.1.254.
DNS	Click the radio button to select the DNS mode: Automatic or Specific.
Current Status	
IP 1	Displays the current IP address 1 of the device.
IP 2	Displays the current IP address 2 of the device.
IP 3	Displays the current IP address 3 of the device.
Save	Click Save to save the values and update the screen.

Note! *All new configurations will take effect after rebooting. To reboot the device, click **Tools > Reboot**.*



6.5 Port Configuration

The serial port configuration menu has Basic, Operation Mode, and Advanced Settings.

6.5.1 Basic

The Basic menu allows for the configuration of the serial interface type, baud rate, parity, data / stop bits, and flow control for port configuration.

To access this page, click **Port Configuration > Basic**.

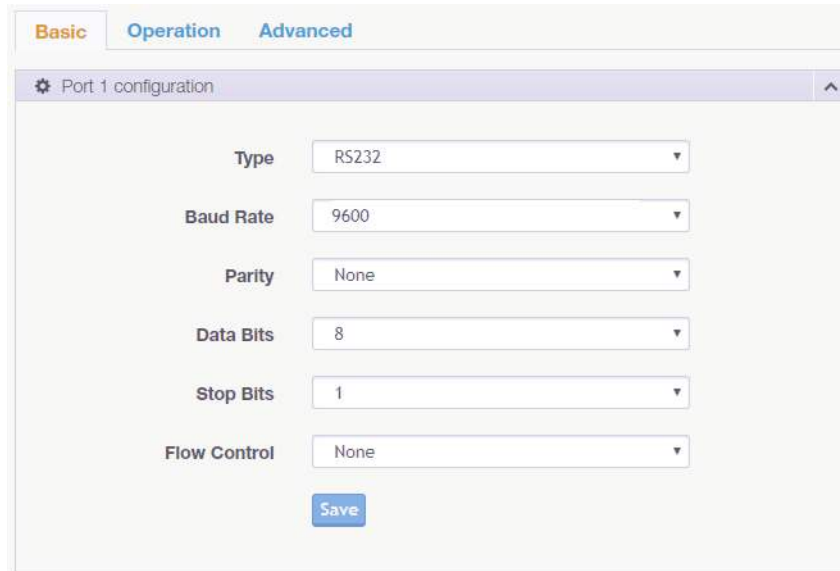

The screenshot shows a web interface for 'Port 1 configuration'. At the top, there are three tabs: 'Basic' (highlighted in orange), 'Operation', and 'Advanced'. Below the tabs is a header bar with a gear icon and the text 'Port 1 configuration'. The main area contains six configuration items, each with a label and a drop-down menu:

- Type: RS232
- Baud Rate: 9600
- Parity: None
- Data Bits: 8
- Stop Bits: 1
- Flow Control: None

At the bottom of the form is a blue 'Save' button.

Figure 6.4 Port Configuration > Basic

The following table describes the items in the previous figure.

Item	Description
Type	By default, the port type is set to L: RS-232, X: RS-422/485.
Baud Rate	Click the drop-down menu to select a baud rate, options include: 300, 600, 1200, 1800, 2400, 4800, 7200, 9600, 14400, 19200, 38400, 57600, 115200, and 230400. The value should conform to the current transmission speeds of connected devices when setting the baud rate.
Parity	Click the drop-down menu to select the parity: None, Odd, Even, Mark or Space.
Data Bits	Click the drop-down menu to select the data bits: 5, 6, 7, or 8.
Stop Bits	Click the drop-down menu to select the stop bits: 1, 1.5 or 2.
Flow Control	Click the drop-down menu to select the flow control mode: None, XOn/XOff, RTS/CTS
Save	Click Save to save the values and update the screen.

6.5.2 Operation

The Operation menu allows for the configuration of the mode type and related attributes for port configuration.

To access this page, click **Port Configuration > Operation**.

Figure 6.5 Port Configuration > Operation

The following table describes the items in the previous figure.

Item	Description
Mode	Click the drop-down menu to select the port configuration mode: Virtual COM Mode, USDG Data Mode, USDG Control Mode or RFC2217 Mode.
Host Idle Timeout(s)	Enter a value to define the host idle timeout period.
Response Timeout(s)	Enter a value to define the response timeout period.
Frame Break(ms)	Enter a value to specify the frame break time.
Pack conditions (Pack sent immediately when reach 1024 Bytes)	
By size	Click the option to sent pack immediately by size.
By interval	Click the option to sent pack immediately by interval.
By end-character	Click the option to sent pack immediately by end-character.
Port Data Buffering	
Media	Click the drop-down menu to select port data buffering type: None or RAM.
When Data Full	Click the drop-down menu to select process mode when data full: Stop.
Save	Click Save to save the values and update the screen.

6.5.3 Advanced

The Advanced menu allows for the configuration of the time delay, buffer data size and FIFO size for port configuration.

To access this page, click **Port Configuration > Advanced**.

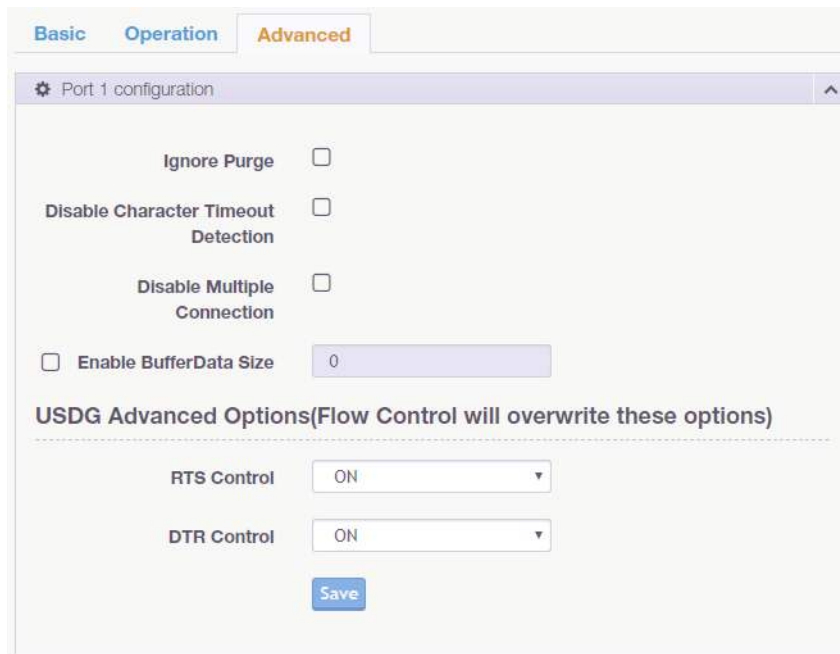

Figure 6.6 Port Configuration > Operation

The following table describes the items in the previous figure.

Item	Description
Ignore Purge	Click the option to purge the serial port when the serial port opens first time.
Disable Character Timeout Detection	Click the option to disable the serial port character timeout detection.
Disable Multiple Connection	Click the option to disable the multi-access function. Then only one TCP connection is allowed on this serial port.
Enable BufferData Size	Click the option to enter the value to queue data to become a packet.
USDG Advanced Options (Flow Control will overwrite these options)	
RTS Control	Click the drop-down menu to select the status of RTS: ON, OFF, Toggle By Connect or Toggle By Data.
Save	Click Save to save the values and update the screen.

6.6 Monitor

The EKI-1511 Series device server allows monitoring of the serial ports' status. The serial port's operation mode and status is available for display. The IP address of the host PC which is communicating with serial port is also displayed.

The Monitor function provides a method to monitor the serial device server's status (operation mode, baud rate, data bits, stop bits, parity and RTS/XON).

Monitoring information is divided into three main message types: Setting/Statistic/Connected IP.

6.6.1 Setting

The Monitor Setting page allows for easy viewing of the port's statistics. To access this page, click **Monitor > Setting**.

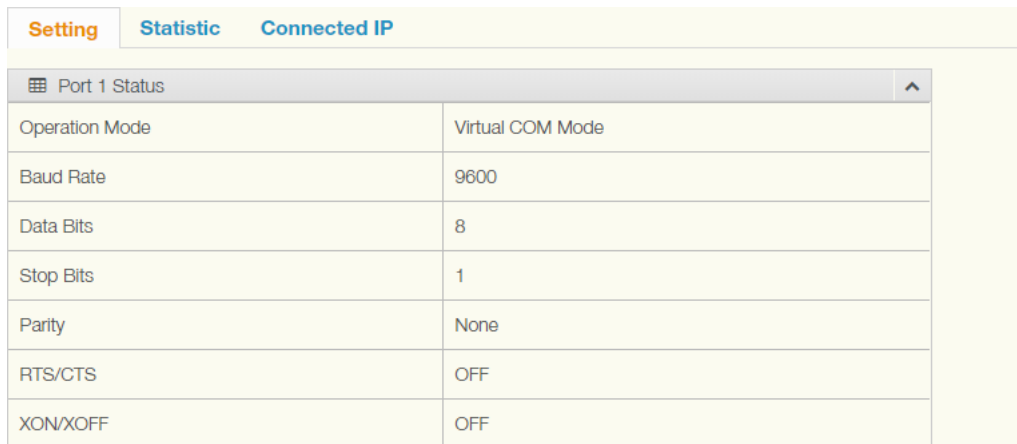

The screenshot shows a web interface with three tabs: 'Setting' (selected), 'Statistic', and 'Connected IP'. Below the tabs is a table titled 'Port 1 Status'. The table has two columns: the left column lists configuration items, and the right column shows their current values.

Port 1 Status	
Operation Mode	Virtual COM Mode
Baud Rate	9600
Data Bits	8
Stop Bits	1
Parity	None
RTS/CTS	OFF
XON/XOFF	OFF

Figure 6.7 Monitor > Setting

The following table describes the items in the previous figure.

Item	Description
Operation Mode	Display the current operation mode of the selected port.
Baud Rate	Display the current baud rate of the selected port.
Data Bits	Display the current data bits of the selected port.
Stop Bits	Display the current stop bits of the selected port.
Parity	Display the current parity of the selected port.
RTS/CTS	Display the current RTS/CTS status of the selected port.
XON/XOFF	Display the current XON/OFF status of the selected port.

6.6.2 Statistic

The Monitor Statistic page allows for easy viewing of the port's TX/RX data count. To access this page, click **Monitor > Statistic**.



The screenshot shows a web interface with three tabs: 'Setting', 'Statistic', and 'Connected IP'. The 'Statistic' tab is active. Below the tabs is a table titled 'Port 1 Status' with a refresh icon and an expand/collapse arrow. The table contains the following data:

Port 1 Status	
Tx Count	0
Rx Count	0
Total Tx Count	0
Total Rx Count	0
RTS	ON
CTS	OFF

Figure 6.8 Monitor > Statistic

The following table describes the items in the previous figure.

Item	Description
Tx Count	Display the current Tx count of the selected port.
Rx Count	Display the current Rx count of the selected port.
Total Tx Count	Display the current total Tx count of the selected port.
Total Rx Count	Display the current total Rx count of the selected port.
RTS	Display the current RTS status of the selected port.
CTS	Display the current CTS status of the selected port.

6.6.3 Connected IP

The Monitor Connected IP page allows for easy viewing of all connected device's IP address.

To access this page, click **Monitor > Connected IP**.

Connected IP	IP Address
IP 1	
IP 2	
IP 3	
IP 4	
IP 5	
IP 6	
IP 7	
IP 8	
IP 9	
IP 10	
IP 11	
IP 12	
IP 13	
IP 14	
IP 15	
IP 16	

Figure 6.9 Monitor > Connected IP

The following table describes the items in the previous figure.

Item	Description
Connected IP	Displays the IP designation for the device.
IP Address	Displays the current connected IP address of the selected port.

6.7 Auto Warning (Alarm)

You can set the e-mail server and SNMP Trap server in the Setting page, and set the event type in the Event page.

6.7.1 Setting

The Alarm Setting menu includes three alarm setting menus for event notification: Mail Sever, SNMP Trap Server, and the SNMP Agent Setting.

At the top of the list is the Mail Server setting which allows you to specify the mail server to be used by the serial device server in order to deliver notifications to selected Email accounts.

The SNMP Trap Server settings allows you to specify the management station of a significant event by way of an unsolicited SNMP message.

The Simple Network Management Protocol (SNMP) is used by the serial device server to collect detailed information about the serial device server.

To access this page, click **Alarm > Setting**.

The screenshot shows a web-based configuration interface for 'Alarm Setting'. It is divided into three sections by dashed lines:

- Mail Server:** Contains a 'Mail Server' field, a 'From Email address' field with the value 'admin@advantech.com', and four 'Email address' fields (1-4).
- SNMP Trap Server:** Contains a 'Trap Server' field, a 'Trap Server Port' field with the value '162', a 'Trap Version' section with radio buttons for 'v1' (selected) and 'v2c', and a 'Trap Community' field with the value 'public'.
- SNMP Agent Setting:** Contains four fields: 'Read Community', 'Write Community', 'Contact', and 'Location'.

A blue 'Save' button is positioned at the bottom center of the form.

Figure 6.10 Alarm > Setting

The following table describes the items in the previous figure.

Item	Description
Mail Server	
Mail Server	Enter the SMTP mail server.
From Email address	Enter the email address.
Email address 1	Enter the email address 1 to receive alarm emails.
Email address 2	Enter the email address 2 to receive alarm emails.
Email address 3	Enter the email address 3 to receive alarm emails.
Email address 4	Enter the email address 4 to receive alarm emails.
SNMP Trap Server	
Trap Server	Enter the SNMP Trap server address.
Trap Server Port	Enter the SNMP Trap server port.
Trap Version	Click the radio button to select the SNMP version credentials: v1 or v2c.
Trap Community	Enter the community string to be passed for the specified event.
SNMP Agent Setting	
Read Community	Enter the read-only, public, community string.
Write Community	Enter the write-only, private, community string.
Contact	Enter the individual designated the contact point for this event.
Location	Enter the designated location/department of the setting.
Save	Click Save to save the values and update the screen.

6.7.2 Event

The Alarm Event page allows the selection of system event triggers to select to and define the notification channel.

To access this page, click **Alarm > Event**.

Event Trigger	Mail	Trap	Log
Cold Start	<input type="checkbox"/>	<input type="checkbox"/>	<input type="checkbox"/>
Warm Start	<input type="checkbox"/>	<input type="checkbox"/>	<input type="checkbox"/>
Authentication failure	<input type="checkbox"/>	<input type="checkbox"/>	<input type="checkbox"/>
IP address changed	<input type="checkbox"/>		
Password changed	<input type="checkbox"/>		
Ethernet1 link down	<input type="checkbox"/>	<input type="checkbox"/>	<input type="checkbox"/>

Save

Figure 6.11 Alarm > Event

The following table describes the items in the previous figure.

Item	Description
System Event	
Cold Start	Click the option to select a warning type when the device server's power is cut off and reconnected.
Warm Start	Click the option to select a warning type when the device server is reboot.
Authentication failure	Click the option to select a warning type when an incorrect password is entered.
IP address changed	Click the option to select a warning type when the IP address is changed.
Password changed	Click the option to select a warning type when the password is changed.
Ethernet1 link down	Click the option to select a warning type when the Ethernet 1 port is disconnected.
Save	Click Save to save the values and update the screen.

6.8 Syslogd

The EKI-1511 Series device server provides the functionality to allow network devices to send event messages to a logging server, also known as a Syslog server, by way of the Syslogd function. The Syslog protocol is supported by a wide range of devices and can be used to log different types of events.

6.8.1 Syslogd Setting

Users can enable the syslogd function to record historical events or messages locally or on a remote syslog server.

To access this page, click **Syslogd > Syslogd Setting**.

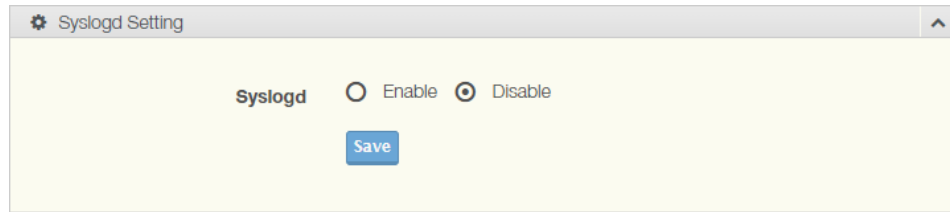

Figure 6.12 Syslogd > Syslogd Setting

The following table describes the items in the previous figure.

Item	Description
Syslogd	Click Enabled or Disabled to set the logging service status.
Save	Click Save to save the values and update the screen.

6.8.2 Syslogd Message

After enabling the syslogd function, users can check the history in the syslogd message page.

To access this page, click **Syslogd > Syslogd Message**.

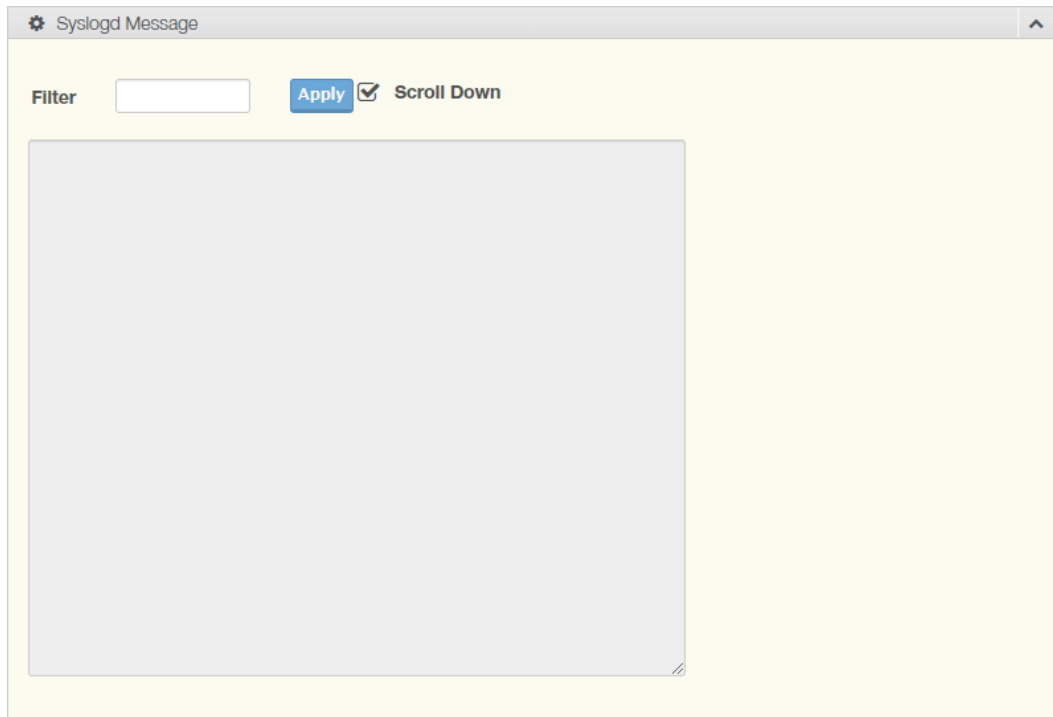

Figure 6.13 Syslogd > Syslogd Message

6.9 Tools

The EKI-1511 Series device server provides tools for access to ping and reset functions.

6.9.1 Ping

The Ping page can help users diagnose Ethernet problems. Users can use the ping page to ask the device to ping a specific target to check the Ethernet network status. The Ping page allows you to configure the test log page.

To access this page, click **Tools > Ping**.

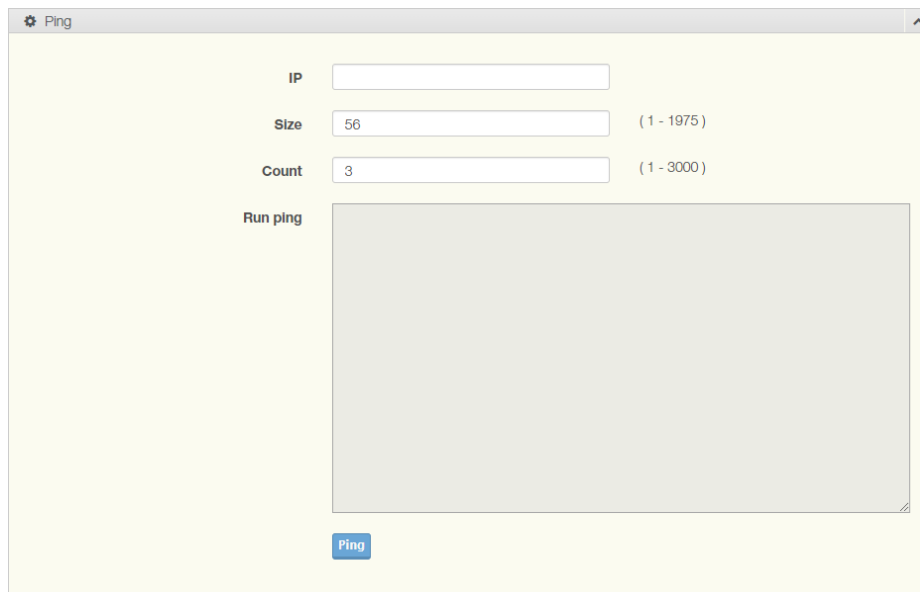

Figure 6.14 Tools > Ping

The following table describes the items in the previous figure.

Item	Description
IP	Enter the IP address or host name of the station to ping. The initial value is blank. The IP Address or host name you enter is not retained across a power cycle. Host names are composed of series of labels concatenated with periods. Each label must be between 1 and 63 characters long, maximum of 64 characters.
Size	Enter the size of ping packet. The default value is 56. The value ranges from 8 to 5120. The size entered is not retained across a power cycle.
Count	Enter the number of echo requests to send. The default value is 4. The value ranges from 1 to 5. The count entered is not retained across a power cycle.
Run ping	Display the ping reply format.

6.9.2 Reboot

The configuration will take effect after clicking Save button. All configurations are saved to flash memory after a system reboot. Press the Reboot button and the system will give a reset response. It will take a few seconds to reconnect with the new values.

To access this page, click **Tools > Reboot**.

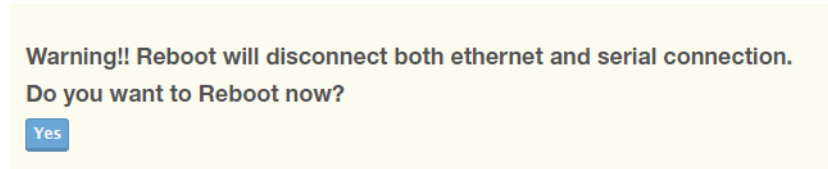

Figure 6.15 Tools > Reboot

Click **Yes** to reboot the serial device server. Any configuration changes you have made since the last time you saved will be lost.

6.10 Management

The EKI-1511 Series device server allows for easy installation and maintenance and reliable maintenance access from anywhere. With the reliable management tools available, you can streamline staffing and troubleshooting requirements to a centralized system.

6.10.1 Log File

If users enable the system event or serial event to log in file, users can download the log file from here.

To access this page, click **Management > Log File**.

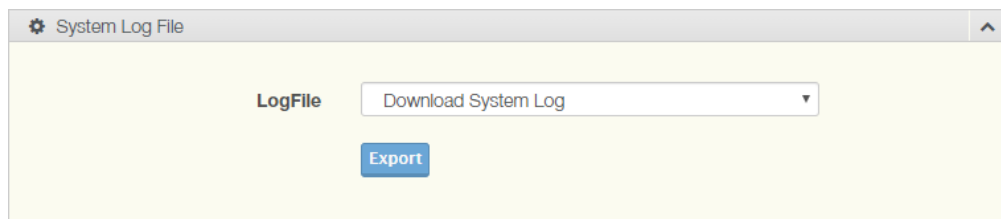

Figure 6.16 Management > Log File

The following table describes the items in the previous figure.

Item	Description
System Log File	Click the drop-down menu to select a specific action for the system log file. Available options: Download System Log, Remove System Log, Download and Remove System Log.
Export	Click Export to download the log file.

6.10.2 Change Password

The Change Password function allows you to easily update your current password from a single menu.

To access this page, click **Management > Change Password**.



Figure 6.17 Management > Change Password

The following table describes the items in the previous figure.

Item	Description
New password	Enter the character set for the define password type.
New password again	Retype the password entry to confirm the profile password.
Save	Click Save to save the values and update the screen.

If you have set a password through the configuration utility or Telnet or serial console, when you access the web configuration, you need to key in the password. It is not necessary to enter the user name in the dialog.

If you want to disable the password protection, change the password to default option **None** (leave the new password column blank). Be sure to press the **Save** button and reboot the serial device server to make the change effective.

6.10.3 Secure access IP

To access this page, click **Management > Secure access IP**.



Figure 6.18 Management > Secure access IP

The following table describes the items in the previous figure.

Item	Description
Access IP number	Enter a value to define access IP number
Save	Click Save to save the values and update the screen.

6.10.4 Export Device Settings

Export the server configuration settings to a .conf file.

To access this page, click **Management > Export**.

Click **Export** to export the serial device server settings.

6.10.5 Import Device Settings

Import the server configuration settings to a .conf file.

To access this page, click **Management > Import**.

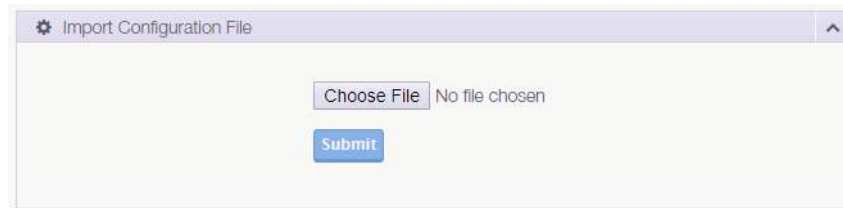

Figure 6.19 Management > Import

The following table describes the items in the previous figure.

Item	Description
Choose File	Click Choose File to select the configuration file.
Submit	Click Submit to backup the settings.

Chapter 7

Telnet/Serial Console
Configuration

7.1 Overview

The purpose of the Console Configuration is to help you manage your device in console mode. One of the main functions of the console mode is to change the web configuration login password. You can use terminal software like Hyper Terminal, Telix and other related terminal software.

7.2 Telnet Console

7.2.1 Create a new connection

You can create a new Telnet connection and assign a connection name for the console configuration.



Figure 7.1 Creating a Telnet Connection

7.2.2 Input the IP address

Confirm that the Telnet console configuration works. Click OK. Be sure that your host PC Ethernet network IP domain is as same as the EKI-1511 Series device server, and the Telnet TCP port number is “23”.

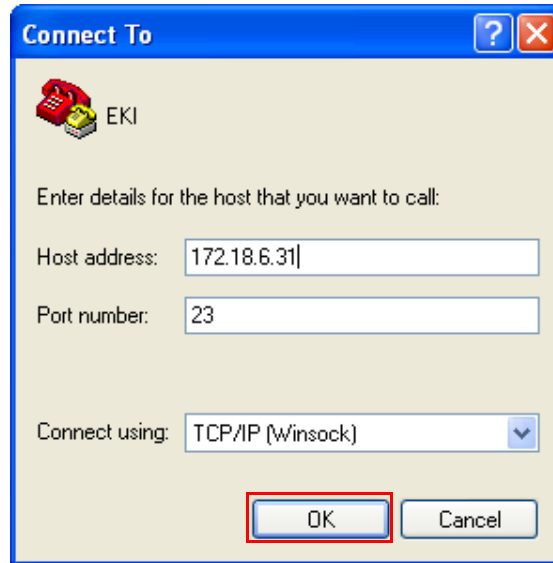

Figure 7.2 Creating a Telnet Connection

7.2.3 Connection Success

After connecting to the serial device server in HyperTerminal console, a welcome greeting displays.

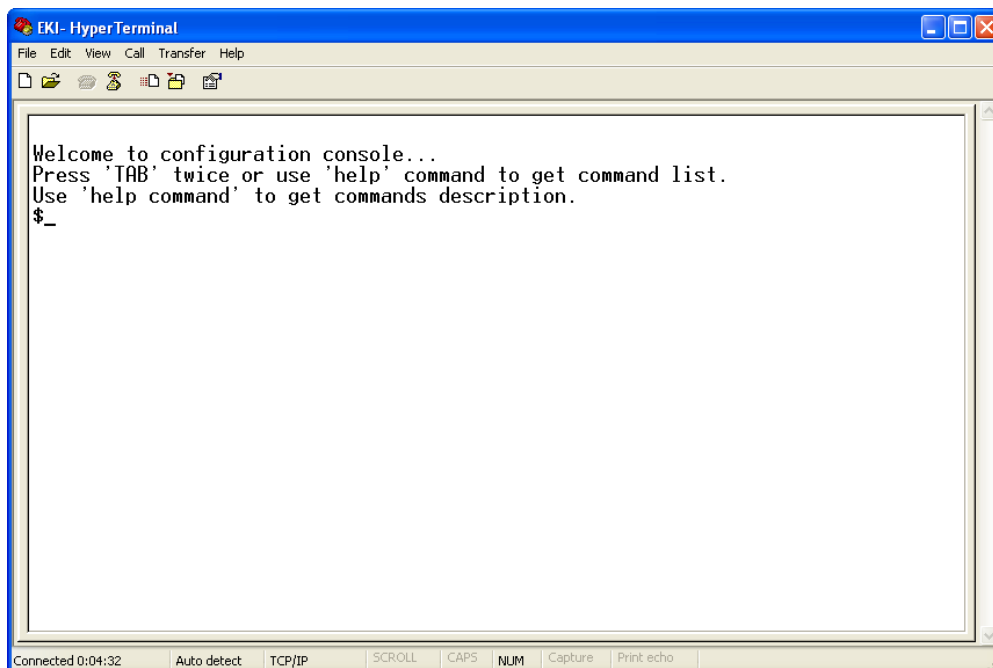

Figure 7.3 Telnet Connection Console

At the command prompt, you can type a “help” followed by the Enter button, or <Tab> twice, to display the command list.

You can toggle between the different command menu options.

7.3 Command List

Command	Function Description
system	Show or configure the system information
port	Show or configure the serial ports information
portadv	Show or configure the serial ports advanced settings
mvcom	Show or configure the serial ports in Virtual COM mode
mctrl	Show or configure the serial ports in Control mode (USDG)
mdata	Show or configure the serial ports in Data mode (USDG)
net	Show or configure the Ethernet ports settings
password	Set or change the password
alarm	Show or configure the auto warning functions including mail alarm and SNMP alarm
monitor	Monitor the serial ports status
mrfc2217	Show all port modes and mode information.
apply	Write settings to the flash memory and reboot the system immediately
exit	Terminate the shell session
help	Display command list help information
reboot	Write settings and reboot the system immediately.

7.3.1 system

Usage: system

Show current device status and informations.

Usage: system name [Maximum length 31 bytes]

Set current device name.

Usage: system desc [Maximum length 127 bytes]

Set current device description.

7.3.2 port

Usage: port [nn|all]

Show port status and informations.

Usage: port [nn] desc [Maximum length 127 bytes]

Set serial port description.

Usage: port [nn|all] type 232 flow []

Set serial port type and flow control.

- flow 0:None.
- flow 1:XOn/XOff.
- flow 2:RTS/CTS.

Usage: port [nn|all] baud [300-230400] parity [] data [5-8] stop [1|1.5|2]

Set serial baud rate, parity and numbers of data bits, numbers of stop bits.

Acceptable baud: 300, 600, 1200, 1800, 2400, 4800, 7200, 9600, 14400, 19200, 38400, 57600, 115200, and 230400

- parity n: None Parity.
- parity e: Even Parity.
- parity o: Odd Parity.
- parity m: Mark Parity.
- parity s: Space Parity.

Usage: port [nn|all] mode [vcom|ctrl|data]

Set serial port as virtual COM port or control mode or data mode.

7.3.3 portadv

\$ help portadv

Show port advanced setting.

Usage: portadv [nn|all] delayT []

Set delay time(ms).

Usage: portadv [nn|all] ignorepurge [TRUE|FALSE] dischato [TRUE|FALSE] dismulti-
con [TRUE|FALSE]

Enable or disable the feature of ignore purge,

Disable character timeout detection, and disable multiple connection.

Usage: portadv [nn|all] databuf []

Set databuffer threshold.

Usage: portadv [nn|all] rts []

Set port RTS status.

– value 0: None Setting.

– value 1: Setting power on.

– value 2: Setting accept on.

– value 4: Setting transmission on.

7.3.4 mvcom

Usage: mvcom

Show all port mode and mode informations.

Usage: mvcom [nn|all]

Set port [nn|all] as virtual COM port mode.

Usage: mvcom [nn|all] idleto []

Set host idle timeout(s).

Usage: mvcom [nn|all] respto [] framebk []

Set response timeout(ms) and frame break(ms).

Usage: mvcom [nn|all] bysize []

Usage: mvcom [nn|all] bytime []

Usage: mvcom [nn|all] bychar [NULL]

Set datapackage as size (bytes) or time (ms) and character (HEX).

– value 0: None Setting.

7.3.5 mctrl

Usage: mctrl

Show port mode and mode informations.

Usage: mctrl [nn|all]

Set port [nn|all] as control mode.

Usage: mctrl [nn|all] idleto [] tcpp [] atp [] guardt [] hangchr []

Set data idle timeout(s) data listen port command listen port guard time(ms)
hangup character.

7.3.6 **mdata**

Usage: mdata

Show port mode and mode informations.

Usage: mdata [nn|all]

Set port [nn|all] as data mode.

Usage: mdata [nn|all] protocol [TCP|UDP]

Set transmit protocol as TCP or UDP.

Usage: mdata [nn|all] idleto [] lsport [] atport []

Set data idle timeout(s) listen port and AT command port.

Usage: mdata [nn|all] respto [] framebk []

Set response timeout(ms) and frame break(ms).

Usage: mdata [nn|all] bysize [] bytime [] bychar [NULL] bychartimeout [ON|OFF]

Set datapackage as size (bytes) or time (ms) or character (HEX) and character-timeout.

– value 0: None Setting.

Usage: mdata [nn|all] autopeerip [ON|OFF]

Set auto connect to peer ip as on or off.

Usage: mdata [nn|all] peernum [1-16] peer [d.d.d.d:d] ...

Set peer IP address and port for receive data.

7.3.7 **net**

Usage: net [1|2]

Show device network status and informations.

Usage: net [1|2] mode [static|dhcp|bootp|all]

Set network operating mode.

Usage: net [1|2] ip [d.d.d.d] netmask [d.d.d.d] gw [d.d.d.d]

Set IP address and subnet mask and gateway.

Usage: net [1|2] dns [auto|specific]

Enable/Disable DNS.

Usage: net [1|2] dns1 [d.d.d.d]

Set network DNS1.

Usage: net [1|2] dns2 [d.d.d.d]

Set network DNS2.

Usage: net [1|2] to [d]

Set network timeout.

7.3.8 **password**

Usage: password

Display two different Usage.

Usage: password new [1-31 characters]

Set new password.

Usage: password old [**...] new [1-31 characters]

Confirm the old password and set new password.

7.3.9 **alarm**

Usage: alarm

Show current alarm informations.

Usage: alarm mail server [null|address] from [null|address] to1 [null|address] to2 [null|address] to3 [null|address] to4 [null|address]

Set current mail server configuration.

Usage: alarm trap server [null|address] ver [1|2] community [null|name]

Set current trap server configuration.

Usage: alarm agent rcommunity [null|name] wcommunity [null|name] contact [null|name] location [null|name]

Set current snmp agent configuration.

Usage: alarm event mail [cstart] [wstart] [auth] [ip] [passwd] [eth1]

Set current mail event configuration.

Usage: alarm event trap [cstart] [wstart] [auth] [eth1]

Set current trap event configuration.

7.3.10 monitor

Usage: monitor port [1|2|..] setting

Monitor COM port setting.

Usage: monitor port [1|2|..] statistic

Monitor COM port statistic data.

Usage: monitor port [1|2|..] ip

Monitor connected IP.

7.3.11 time

Usage: time

Show current time informations.

Usage: time [YYYYMMDDhhmmss]

Set current time configuration.

Usage: time ntp [timeserver]

Set current time server configuration.

7.3.12 **service**

Usage: service telnet [enable|disable]

Enable/Disable telnet function.

Usage: service snmp [enable|disable]

Enable/Disable SNMP function.

7.3.13 **mrfc2217**

Usage: mrfc2217

Show all port mode and mode informations.

Usage: mrfc2217 [nn|all]

Set port [nn|all] as RFC2217 mode.

Usage: mrfc2217 [nn|all] idleto [] lsport []

Set host idle timeout(s) and listen port.

7.3.14 **apply**

Usage: apply

Save the settings to flash and reboot right now.

7.3.15 **exit**

Usage: exit

Terminate shell session.

7.3.16 **help**

Usage: help [cmd]

Display help information of command cmd.

7.3.17 **reboot**

Usage: reboot

Write settings and reboot the system immediately.

Chapter 8

TCP and UDP Port
Numbers

8.1 List of Known TCP and UDP Port Numbers

Port	Protocol	Service
5048	(TCP/UDP)	Configuration Utility
5058	(TCP/UDP)	Configuration Utility
5202	(TDP)	VCOM
9999	(TDP)	Firmware Download
22	(TDP)	SSH
23	(TDP)	Telnet
25	(TDP)	SMTP (Mail Client)
53	(TCP/UDP)	DNS
67	(UDP)	BOOTP Server/DHCP
68	(UDP)	BOOTP Client/DHCP
80	(TDP)	Web Interface/HTTP
123	(TDP)	NTP
161	(TDP)	SNMP
162	(TCP/UDP)	SNMP Trap
443	(TDP)	HTTPS
502	(TDP)	Modbus/TCP (Default)
514	(TDP)	Syslog

ADVANTECH

Enabling an Intelligent Planet

www.advantech.com

Please verify specifications before quoting. This guide is intended for reference purposes only.

All product specifications are subject to change without notice.

No part of this publication may be reproduced in any form or by any means, electronic, photocopying, recording or otherwise, without prior written permission of the publisher.

All brand and product names are trademarks or registered trademarks of their respective companies.

© Advantech Co., Ltd. 2021