

LIGHT PIPES SECURED TO METAL COVER

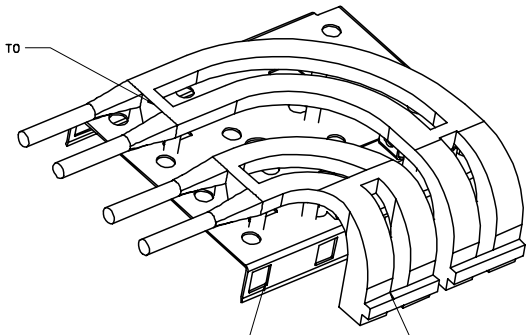

COVER DESIGNED TO SNAP ON THE GANGED CAGE ASSEMBLY

LIGHT PIPES MOLDED WITH VO RATED MATERIAL

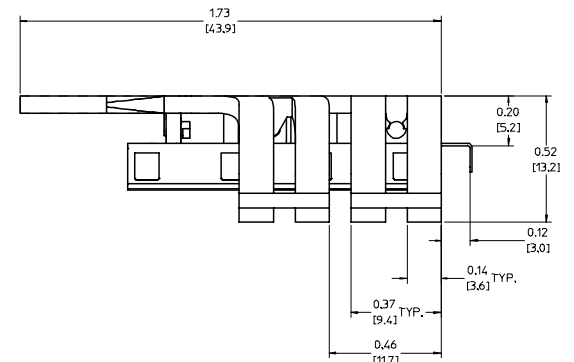
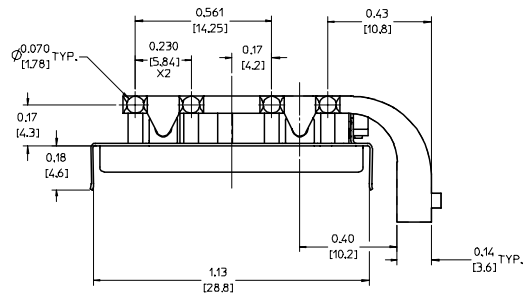

NOTES:

1. THIS LIGHT PIPE ASSEMBLY TO BE USED WITH THE FOLLOWING 1X2 GANGED CAGE ASSEMBLIES:

747220001 - 1X2 GANGED CAGE ASSEMBLY W/ PRESS FIT LEGS (REFER TO DOCUMENT SD-74722-001 FOR CAGE DETAILS)
2. IT IS RECOMMENDED THAT THE CAGE ASSEMBLY BE PRESSED INTO THE PCB PRIOR TO ASSEMBLING THE LIGHT PIPE ASSEMBLY.
3. LED'S TO HAVE A MAXIMUM HEIGHT OF 1.4mm AND A MINIMUM HEIGHT OF 0.7mm.
4. RECOMMENDED LED'S INCLUDE THE FOLLOWING MANUFACTURES:

DIALIGHT: 597-77x1-5xx SERIES

CHICAGO MINIATURE: 7016 SERIES

KINGBRIGHT: APBL3025 SERIES (BICOLOR)
APL3015 SERIES (SINGLE COLOR)

5. THIS PART MEETS THE RESTRICTION OF HAZARDOUS SUBSTANCES IN ELECTRICAL AND ELECTRONIC EQUIPMENT (ROHS) DIRECTIVE (2002/95/EC).

ENTER DESCRIPTION EC NO: UST2006-0008 DRAWN BY: JORWANSI MONSON 2005/07/15 CHECKED BY: CHFKBRUSSELL 2005/07/15 APPROVED BY: BRUSSELL 2005/07/25	QUALITY SYMBOLS ▽=0 ▽=0	GENERAL TOLERANCES (UNLESS SPECIFIED)	DIMENSION STYLE IN/MM	SCALE 4:1	DESIGN UNITS METRIC	THIRD ANGLE PROJECTION
	DESCRIPTION	mm INCH	DRAWN BY DATE KS IMONSO 2004/07/08	TITLE 1X2 SFP LIGHT PIPE ASSEMBLY, SIDE-TOP	MATERIAL NO. 747270002 DOCUMENT NO. SD-74727-002	
DRAFT WHERE APPLICABLE MUST REMAIN WITHIN DIMENSIONS		4 PLACES ± .005 3 PLACES ± .005 2 PLACES ± 0.13 ± .01 1 PLACE ± 0.25 ± .01	ANGULAR ± 1 °	CHECKED BY DATE BRUSSELL 2004/07/08	APPROVED BY DATE BRUSSELL 2004/07/08	
SIZE D		THIS DRAWING CONTAINS INFORMATION THAT IS PROPRIETARY TO MOLEX INCORPORATED AND SHOULD NOT BE USED WITHOUT WRITTEN PERMISSION				

PCB LAYOUT FOR BELLY TO BELLY MOUNTING

CROSS-HATCHED AREA DENOTES
COMPONENT AND TRACE KEEP-OUT
(EXCEPT CHASSIS GROUND)

SEE NOTE 3

RECOMMENDED CENTRIX
OF LED

THIS AREA DENOTES
KEEP-OUT FOR LED'S

THIS AREA DENOTES
COMPONENT KEEP-OUT
(TRACES ALLOWED)

NOTES:

1. PADS AND VIAS GO TO CHASSIS GROUND.
2. CAGE MOUNTING THRU HOLES (34 PLACES) TO BE PLATED.
3. HOLE PATTERN REPEATS FOR EACH PORT, SPACING BETWEEN PORTS IS .561 [14.25].

SEE Detail1

SMALLER HOLE ON
THESE FOUR ROWS ONLY

HOST CONNECTOR DETAIL

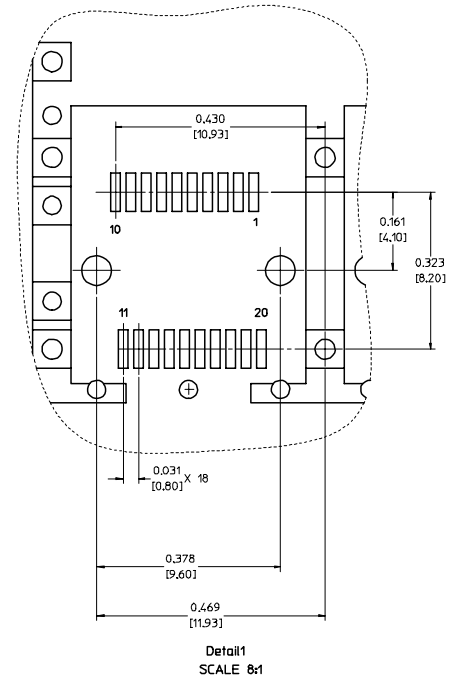

Detail1
SCALE 8:1

ENTER DESCRIPTION EC NO: UST2006-0008 DRINKS/IMONSON 2005/07/15 CHKD:BRUSSELL 2005/07/15 APPR:BRUSSELL 2005/07/25	QUALITY SYMBOLS	GENERAL TOLERANCES (UNLESS SPECIFIED)	DIMENSION STYLE	SCALE	DESIGN UNITS	THIRD ANGLE PROJECTION
	$\nabla=0$ $\nabla=0$	mm INCH 4 PLACES ± --- ± --- 3 PLACES ± --- ± .005 2 PLACES ± 0.13 ± .01 1 PLACE ± 0.25 ± --- ANGULAR ± 1 °	IN/MM	6:1	METRIC	
	DESCRIPTION	DRAWN BY	DATE	TITLE	MOLEX INCORPORATED	
		KS IMONSON	2004/07/08	1X2 SFP LIGHT PIPE ASSEMBLY, SIDE-TOP		
	CHECKED BY	DATE				
	BRUSSELL	2004/07/08				
	APPROVED BY	DATE				
	BRUSSELL	2004/07/08				
DRAFT WHERE APPLICABLE MUST REMAIN WITHIN DIMENSIONS	MATERIAL NO.	DOCUMENT NO.	SHEET NO.			
	747270002	SD-74727-002	2 OF 5			
THIS DRAWING CONTAINS INFORMATION THAT IS PROPRIETARY TO MOLEX INCORPORATED AND SHOULD NOT BE USED WITHOUT WRITTEN PERMISSION						

PCB LAYOUT FOR SINGLE SIDE MOUNTING

CROSS-HATCHED AREA DENOTES
COMPONENT AND TRACE KEEP-OUT
(EXCEPT CHASSIS GROUND)

SEE NOTE 3

TOP LEFT HOLE
OF ADJACENT CAGE

RECOMMENDED CENTRIX
OF LED

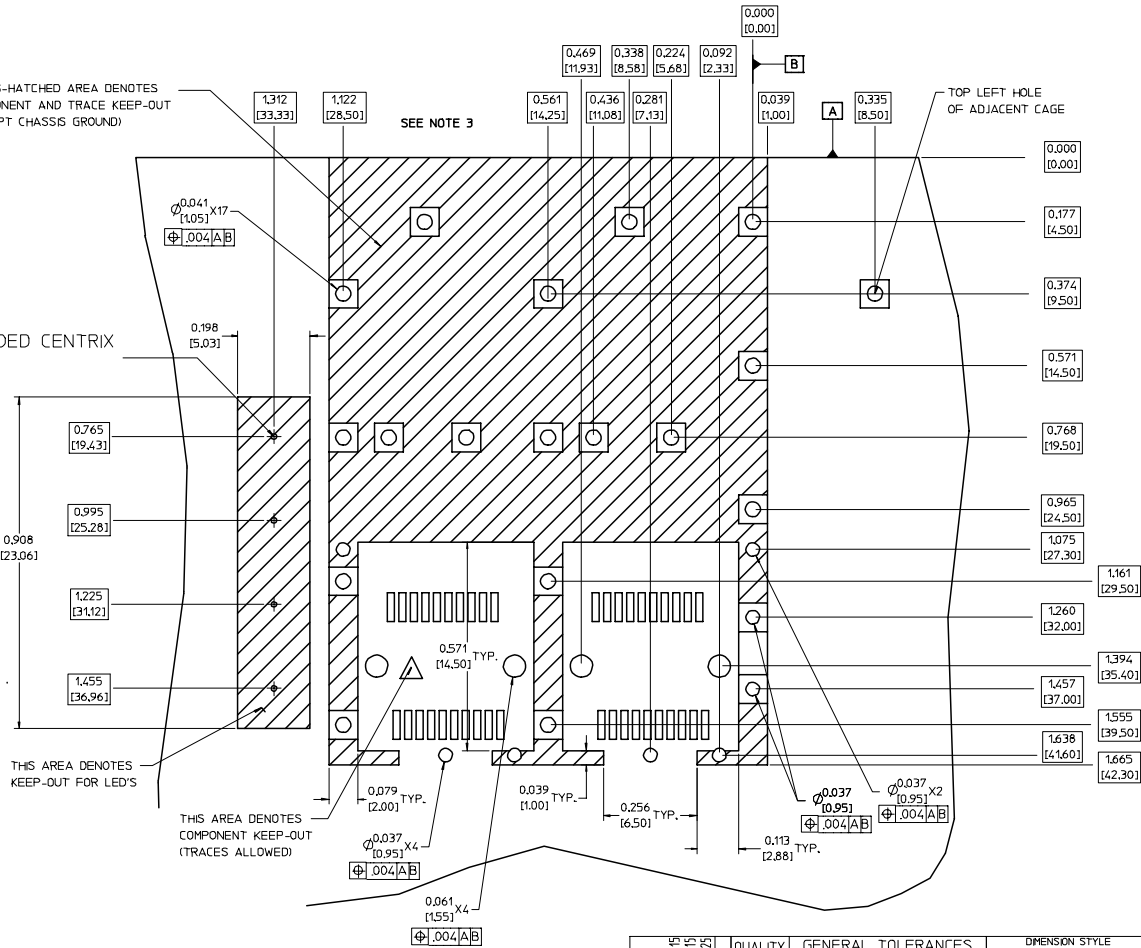

- NOTES:
1. PADS AND VIAS GO TO CHASSIS GROUND.
 2. CAGE MOUNTING THRU HOLES (19 PLACES) TO BE PLATED.
 3. HOLE PATTERN REPEATS FOR EACH PORT.
SPACING BETWEEN PORTS IS .561 (14.25).

ENTER DESCRIPTION EC NO: UST2006-0008 DRINKS MONSON 2005/07/15 CHK:BRUSSELL 2005/07/15 APPR:BRUSSELL 2005/07/25	QUALITY SYMBOLS ▽=0 ▽=0	GENERAL TOLERANCES (UNLESS SPECIFIED) <table border="1"> <tr> <th></th> <th>mm</th> <th>INCH</th> </tr> <tr> <td>4 PLACES ±</td> <td>---</td> <td>±---</td> </tr> <tr> <td>3 PLACES ±</td> <td>---</td> <td>±.005</td> </tr> <tr> <td>2 PLACES ±</td> <td>0.13</td> <td>±.01</td> </tr> <tr> <td>1 PLACE ±</td> <td>0.25</td> <td>±---</td> </tr> <tr> <td colspan="3">ANGULAR ± 1°</td> </tr> </table>		mm	INCH	4 PLACES ±	---	±---	3 PLACES ±	---	±.005	2 PLACES ±	0.13	±.01	1 PLACE ±	0.25	±---	ANGULAR ± 1°			DIMENSION STYLE IN/MM	SCALE 6:1	DESIGN UNITS METRIC	THIRD ANGLE PROJECTION
		mm	INCH																					
	4 PLACES ±	---	±---																					
	3 PLACES ±	---	±.005																					
2 PLACES ±	0.13	±.01																						
1 PLACE ±	0.25	±---																						
ANGULAR ± 1°																								
DRAFT WHERE APPLICABLE MUST REMAIN WITHIN DIMENSIONS		DRAWN BY DATE KS IMONSO 2004/07/08 CHECKED BY DATE BRUSSELL 2004/07/08 APPROVED BY DATE BRUSSELL 2004/07/08		TITLE 1X2 SFP LIGHT PIPE ASSEMBLY, SIDE-TOP																				
MATERIAL NO. 747270002		DOCUMENT NO. SD-74727-002			MOLEX INCORPORATED																			
THIS DRAWING CONTAINS INFORMATION THAT IS PROPRIETARY TO MOLEX INCORPORATED AND SHOULD NOT BE USED WITHOUT WRITTEN PERMISSION				SHEET NO. 3 OF 5																				

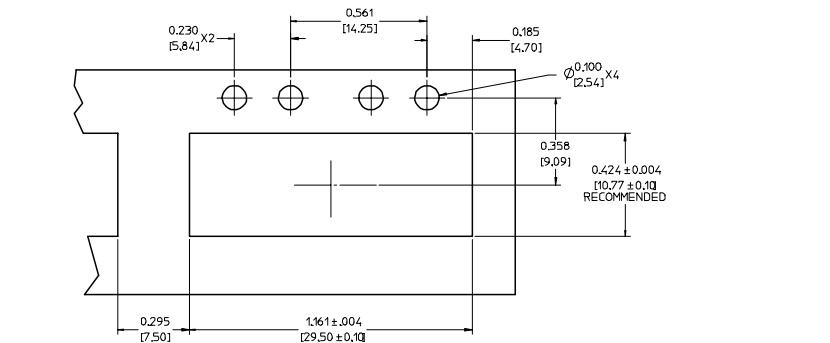

BEZEL AND BOARD POSITION DIMENSIONS FOR SINGLE SIDE MOUNTING

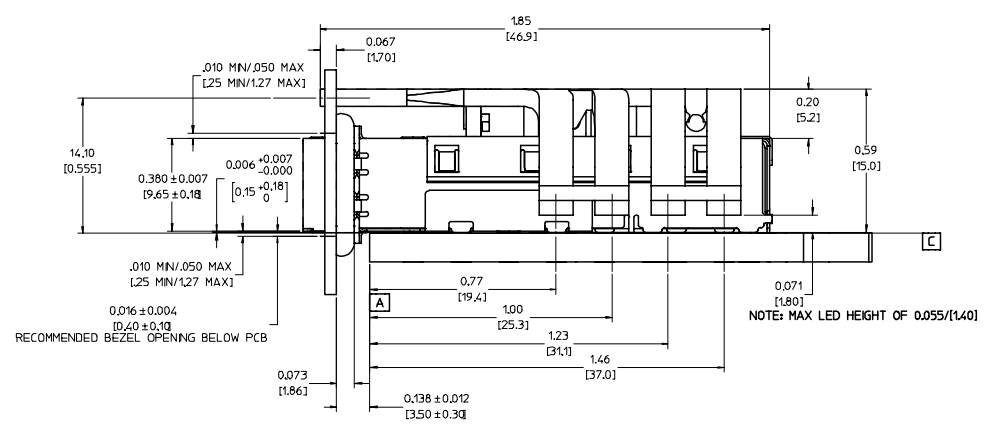

BEZEL AND BOARD POSITION DIMENSIONS FOR BELLY TO BELLY MOUNTING

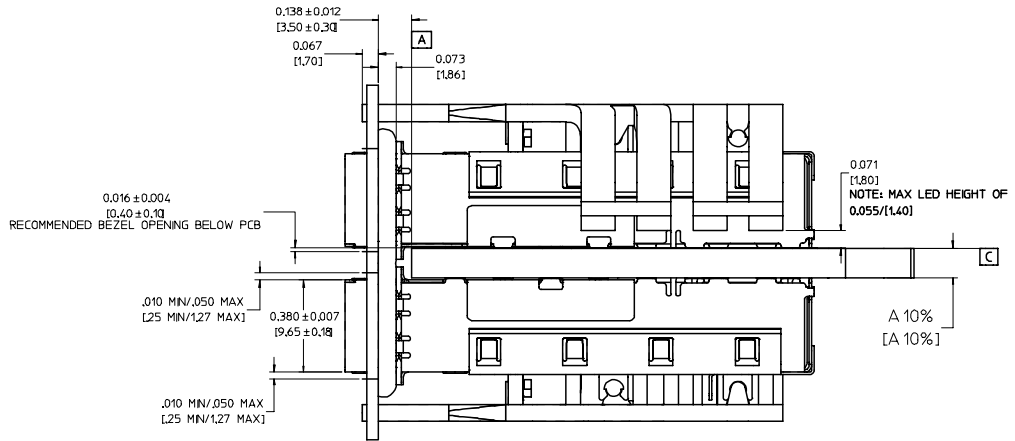
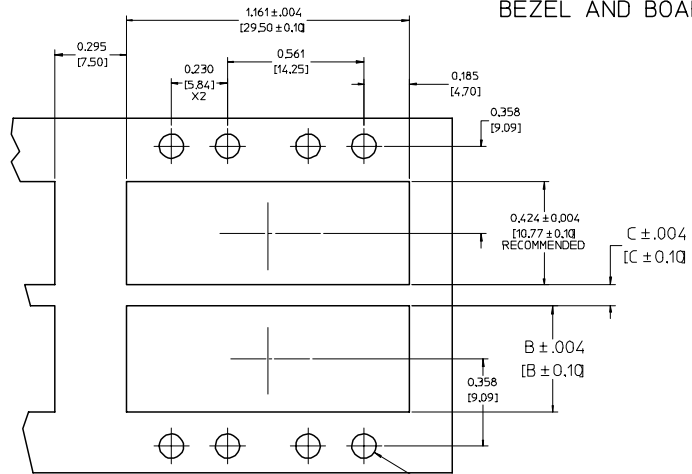

NOTE: FOR A GIVEN BOARD THICKNESS (A), DIMENSIONS (B) AND (C) ARE DIRECTLY AFFECTED.





USE RECOMMENDED DIMENSIONS AND TOLERANCES TO AID IN DEVELOPING BEZEL OPENING.

FOR EXAMPLE USING A BOARD THICKNESS OF .125" THE RECOMMENDED VALUES WOULD BE:

- A= .125/3.18 ± 10%
- B= .434/11.03 ± .004
- C= .088/2.23 ± .004

ENTER DESCRIPTION EC NO: UST2006-0008 DRAWN BY: JORWANKS MONSON 2005/07/15 CHECKED BY: CHUCK BRUSSELL 2005/07/15 APPROVED BY: BRUSSELL 2005/07/25 REV DESCRIPTION	QUALITY SYMBOLS	GENERAL TOLERANCES (UNLESS SPECIFIED)	DIMENSION STYLE	SCALE	DESIGN UNITS	THIRD ANGLE PROJECTION
	▽=0 ▽=0	mm INCH 4 PLACES ± --- ± --- 3 PLACES ± --- ± .005 2 PLACES ± 0.13 ± .01 1 PLACE ± 0.25 ± --- ANGULAR ± 1 °	IN/MM DRAWN BY: KS IMONSO 2004/07/08 CHECKED BY: BRUSSELL 2004/07/08 APPROVED BY: BRUSSELL 2004/07/08	4:1	METRIC	TITLE: 1X2 SFP LIGHT PIPE ASSEMBLY, SIDE-TOP MOLEX INCORPORATED
	DRAFT WHERE APPLICABLE MUST REMAIN WITHIN DIMENSIONS	MATERIAL NO: 747270002	DOCUMENT NO: SD-74727-002	SHEET NO: 4 OF 5		
	SIZE D	THIS DRAWING CONTAINS INFORMATION THAT IS PROPRIETARY TO MOLEX INCORPORATED AND SHOULD NOT BE USED WITHOUT WRITTEN PERMISSION				

DATE	REV	CHANGES	COMMENTS
2003/11/04	1	PRELIMINARY DOCUMENT	N/A
2004/07/08	A	INITIAL RELEASE	N/A
2005/06/03	B	CORRECTED P/N FOR DIALIGHT LED	DOCUMENT CHANGE ONLY
2005/06/10	C	UPDATED VIEWS TO SHOW CLEARANCE HOLES ADDED TO THE COVER.	N/A

ENTER DESCRIPTION EC NO: UST2006-0008 DRAWN BY: JORWANKI MONSON 2005/07/15 CHECKED BY: CHFKO BRUSSELL 2005/07/15 APPROVED BY: BRUSSELL 2005/07/25	QUALITY SYMBOLS  =0  =0	GENERAL TOLERANCES (UNLESS SPECIFIED) <table border="1"> <thead> <tr> <th></th> <th>mm</th> <th>INCH</th> </tr> </thead> <tbody> <tr> <td>4 PLACES</td> <td>± .---</td> <td>± .---</td> </tr> <tr> <td>3 PLACES</td> <td>± .---</td> <td>± .005</td> </tr> <tr> <td>2 PLACES</td> <td>± 0.13</td> <td>± .01</td> </tr> <tr> <td>1 PLACE</td> <td>± 0.25</td> <td>± .---</td> </tr> <tr> <td colspan="3">ANGULAR ± 1 °</td> </tr> </tbody> </table>		mm	INCH	4 PLACES	± .---	± .---	3 PLACES	± .---	± .005	2 PLACES	± 0.13	± .01	1 PLACE	± 0.25	± .---	ANGULAR ± 1 °			DIMENSION STYLE IN/MM	SCALE 1:1	DESIGN UNITS METRIC	 THIRD ANGLE PROJECTION
				mm	INCH																			
4 PLACES	± .---	± .---																						
3 PLACES	± .---	± .005																						
2 PLACES	± 0.13	± .01																						
1 PLACE	± 0.25	± .---																						
ANGULAR ± 1 °																								
DRAFT WHERE APPLICABLE MUST REMAIN WITHIN DIMENSIONS	DRAWN BY: KS IMONSO 2004/07/08 CHECKED BY: BRUSSELL 2004/07/08 APPROVED BY: BRUSSELL 2004/07/08	TITLE 1X2 SFP LIGHT PIPE ASSEMBLY, SIDE-TOP	MATERIAL NO. 747270002	DOCUMENT NO. SD-74727-002	 MOLEX INCORPORATED	SHEET NO. 5 OF 5																		

THIS DRAWING CONTAINS INFORMATION THAT IS PROPRIETARY TO MOLEX INCORPORATED AND SHOULD NOT BE USED WITHOUT WRITTEN PERMISSION