



# 17µA Max, Dual/Quad, Single-Supply, Precision Op Amps

MAX478/MAX479

## General Description

The MAX478 and MAX479 are dual and quad micro-power, precision op amps available in 8-pin and 14-pin DIP and small-outline packages, respectively. Both devices feature an extremely low, 17µA max supply current per op amp, 70µV max offset voltage, 2.2µV/°C max offset voltage drift (0.5µV/°C typ), and 250pA max input offset current.

The MAX478 and MAX479 operate from a single supply. The input voltage range includes ground, and the output swings to within a few millivolts of ground, which eliminates pull-down resistors and saves power.

Both devices are optimized for single 3V and 5V supply operation, with guaranteed specifications at each supply voltage. Specifications for ±15V operation are also provided.

## Applications

Battery- or Solar-Powered Systems:

- Portable Instrumentation
- Remote Sensor Amplifier
- Satellite Circuitry

Micropower Sample-and-Hold

Thermocouple Amplifier

Micropower Filters

Single Lithium Cell Powered Systems

## Typical Operating Circuit

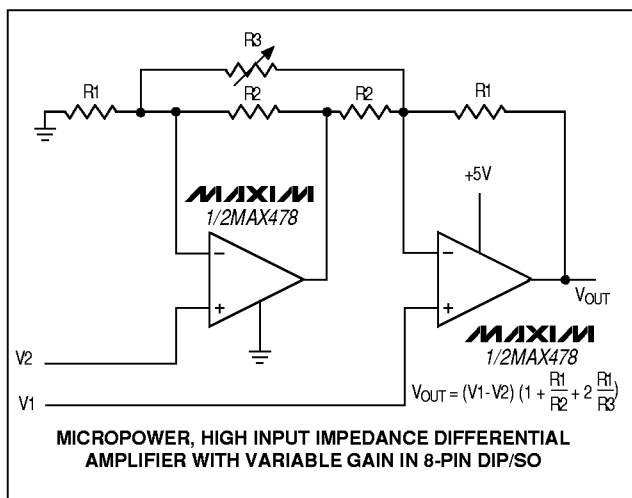

## Features

- ◆ 17µA Max Supply Current (MAX478A/MAX479A)
- ◆ 70µV Max Offset Voltage (MAX478A)
- ◆ Single-Supply Operation:
  - Input Voltage Range Includes Ground
  - Output Swings to Ground While Sinking Current
  - No Pull-Down Resistors Required
- ◆ Dual Op Amp in 8-Pin DIP/SO Package (MAX478)  
Quad Op Amp in 14-Pin DIP/SO Package (MAX479)
- ◆ 250pA Max Input Offset Current (MAX478A/MAX479A)
- ◆ 0.5µV/°C Offset-Voltage Drift
- ◆ Output Sources and Sinks 5mA Load Current

## Ordering Information

PART	TEMP. RANGE	PIN-PACKAGE
MAX478ACPA	0°C to +70°C	8 Plastic DIP
MAX478CPA	0°C to +70°C	8 Plastic DIP
MAX478CSA	0°C to +70°C	8 SO
MAX478C/D	0°C to +70°C	Dice*
MAX478EPA	-40°C to +85°C	8 Plastic DIP
MAX478ESA	-40°C to +85°C	8 SO
MAX479ACPD	0°C to +70°C	14 Plastic DIP
MAX479CPD	0°C to +70°C	14 Plastic DIP
MAX479CSD	0°C to +70°C	14 SO
MAX479EPD	-40°C to +85°C	14 Plastic DIP
MAX479ESD	-40°C to +85°C	14 SO

\* Dice are specified at  $T_A = +25^\circ\text{C}$ , DC parameters only.

## Pin Configurations

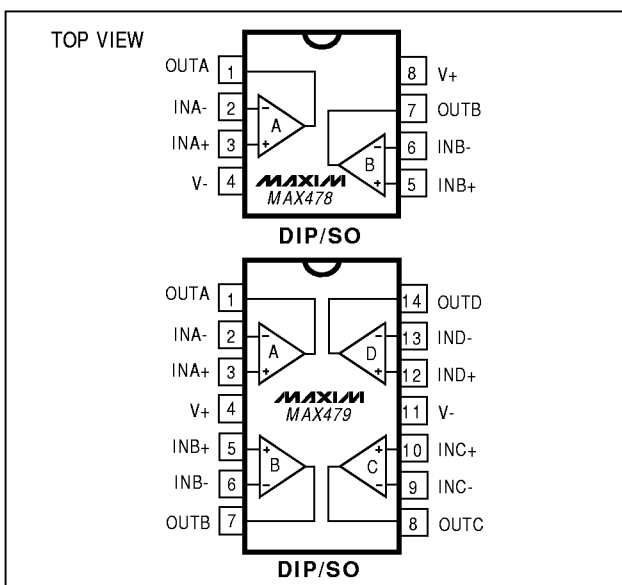

# 17 $\mu$ A Max, Dual/Quad, Single-Supply, Precision Op Amps

## ABSOLUTE MAXIMUM RATINGS

Supply Voltage ..... $\pm$ 22V  
 Differential Input Voltage ..... $\pm$ 30V  
 Input Voltage ..... Equal to Positive Supply Voltage  
 5V Below Negative Supply Voltage  
 Output Short-Circuit Duration ..... Continuous  
 Continuous Power Dissipation ( $T_A = +70^\circ\text{C}$ ):  
 8-Pin Plastic DIP (derate 9.09mW/ $^\circ\text{C}$  above  $+70^\circ\text{C}$ ) ..... 727mW  
 14-Pin Plastic DIP (derate 10.00mW/ $^\circ\text{C}$  above  $+70^\circ\text{C}$ ) .. 800mW  
 14-Pin Wide SO (derate 9.52mW/ $^\circ\text{C}$  above  $+70^\circ\text{C}$ ) ... 762mW

Operating Temperature Ranges:  
 MAX47\_ACP\_/C\_..... $0^\circ\text{C}$  to  $+70^\circ\text{C}$   
 MAX47\_E\_..... $-40^\circ\text{C}$  to  $+85^\circ\text{C}$   
 Storage Temperature Range .....  $-65^\circ\text{C}$  to  $+150^\circ\text{C}$   
 Lead Temperature (soldering, 10sec).....  $+300^\circ\text{C}$

Stresses beyond those listed under "Absolute Maximum Ratings" may cause permanent damage to the device. These are stress ratings only, and functional operation of the device at these or any other conditions beyond those indicated in the operational sections of the specifications is not implied. Exposure to absolute maximum rating conditions for extended periods may affect device reliability.

## ELECTRICAL CHARACTERISTICS: 5V

( $V_S = 5\text{V}$ ,  $0\text{V}$ ,  $V_{CM} = 0.1\text{V}$ ,  $V_O = 1.4\text{V}$ ,  $T_A = +25^\circ\text{C}$ , unless otherwise noted.)

PARAMETER	SYMBOL	CONDITIONS	MAX478AC MAX479AC			MAX478C/E MAX479C/E			UNITS
			MIN	TYP	MAX	MIN	TYP	MAX	
Input Offset Voltage	$V_{OS}$	MAX478ACP/CP/EP	30	70		40	120	$\mu\text{V}$	
		MAX479ACP/CP/EP	35	100		40	150		
		MAX478CS/ES				80	180		
		MAX479CS/ES				90	250		
Long-Term Input Offset-Voltage Stability	$\frac{\Delta V_{OS}}{\Delta \text{Time}}$		0.5		0.6		$\mu\text{V}/\text{Mo.}$		
Input Offset Current	$I_{OS}$		0.05	0.25	0.05	0.35	nA		
Input Bias Current	$I_B$		3	5	3	6	nA		
Input Noise Voltage	$e_n$	0.1Hz to 10Hz (Note 1)	0.9	2.0	0.9		$\mu\text{V}_{p-p}$		
Input Noise Voltage Density		$f_o = 10\text{Hz}$ (Note 1)	50	75	50		$\text{nV}/\sqrt{\text{Hz}}$		
		$f_o = 1000\text{Hz}$ (Note 1)	49	65	49				
Input Noise Current	$i_n$	0.1Hz to 10Hz (Note 1)	1.5	2.5	1.5		$\text{pA}_{p-p}$		
Input Noise Current Density		$f_o = 10\text{Hz}$ (Note 1)	0.03	0.07	0.03		$\text{pA}/\sqrt{\text{Hz}}$		
		$f_o = 1000\text{Hz}$	0.01		0.01				
Input Resistance	$R_{IN}$	Differential mode (Note 1)	0.8	2.0	0.6	2.0	$\text{G}\Omega$		
		Common mode		12		12			
Input Voltage Range	$V_{IN(CM)}$	Upper limit	3.5	3.9	3.5	3.9	V		
		Lower limit	0	-0.3	0	-0.3			
Common-Mode Rejection Ratio	CMRR	$V_{CM} = 0\text{V}$ to 3.5V	93	103	90	102	dB		
Power-Supply Rejection Ratio	PSRR	$V_S = 2.2\text{V}$ to 12V	94	104	92	104	dB		
Large-Signal Voltage Gain	$A_{VOL}$	$V_O = 0.03\text{V}$ to 4V, no load (Note 1)	140	700	110	700	V/mV		
		$V_O = 0.03\text{V}$ to 3.5V, $R_L = 50\text{k}\Omega$	80	200	70	200			

# 17μA Max, Dual/Quad, Single-Supply, Precision Op Amps

MAX478/MAX479

## ELECTRICAL CHARACTERISTICS: 5V (continued)

(V<sub>S</sub> = 5V, 0V, V<sub>CM</sub> = 0.1V, V<sub>O</sub> = 1.4V, T<sub>A</sub> = +25°C, unless otherwise noted.)

PARAMETER	SYMBOL	CONDITIONS	MAX478AC MAX479AC			MAX478C/E MAX479C/E			UNITS
			MIN	TYP	MAX	MIN	TYP	MAX	
Output Voltage Swing	V <sub>OUT</sub>	Output low, no load	6.5	9.0		6.5	9.0	mV	
		Output low, 2kΩ to GND	0.2	0.6		0.2	0.6		
		Output low, I <sub>SINK</sub> = 100μA	120	160		120	160		
		Output high, no load	4.2	4.4		4.2	4.4	V	
		Output high, 2kΩ to GND	3.5	3.8		3.5	3.8		
Slew Rate	SR	A <sub>V</sub> = +1, C <sub>L</sub> = 1pF (Note 1)	0.013	0.025		0.013	0.025	V/μs	
Gain-Bandwidth Product	GBW	f <sub>O</sub> ≤ 5kHz	60			60			kHz
Supply Current per Amplifier	I <sub>S</sub>		13	18		14	21	μA	
		V <sub>S</sub> = ±1.5V, V <sub>O</sub> = 0V	12	17		13	20		
Channel Separation		ΔV <sub>IN</sub> = 3V, R <sub>L</sub> = 10kΩ	130			130			dB
Minimum Supply Voltage	V <sub>S</sub>	(Note 2)	2.0	2.2		2.0	2.2	V	

## ELECTRICAL CHARACTERISTICS: 5V

(V<sub>S</sub> = 5V, 0V, V<sub>CM</sub> = 0.1V, V<sub>O</sub> = 1.4V, T<sub>A</sub> = 0°C to +70°C, unless otherwise noted.)

PARAMETER	SYMBOL	CONDITIONS	MAX478AC MAX479AC			MAX478C MAX479C			UNITS
			MIN	TYP	MAX	MIN	TYP	MAX	
Input Offset Voltage	V <sub>OS</sub>	MAX478ACP/CP	50	170		65	250	μV	
		MAX479ACP/CP	60	200		70	290		
		MAX478CS				120	300		
		MAX479CS				130	400		
Input Offset Voltage Drift	ΔV <sub>OS</sub> ΔT	MAX47_ACP/CP (Note 1)	0.5	2.2		0.6	3.0	μV/°C	
		MAX47_CS (Note 1)				0.8	4.5		
Input Offset Current	I <sub>OS</sub>		0.06	0.35		0.06	0.50	nA	
Input Bias Current	I <sub>B</sub>		3	6		3	7	nA	
Common-Mode Rejection Ratio	CMRR	V <sub>CM</sub> = 0V to 3.4V	90	101		86	100	dB	
Power-Supply Rejection Ratio	PSRR	V <sub>S</sub> = 2.5V to 12V	90	102		88	102	dB	
Large-Signal Voltage Gain	A <sub>VOL</sub>	V <sub>O</sub> = 0.05V to 4V, no load (Note 1)	105	500		80	500	V/mV	
		V <sub>O</sub> = 0.05V to 3.5V, R <sub>L</sub> = 50kΩ	55	160		45	160		
Output Voltage Swing	V <sub>OUT</sub>	Output low, no load	8	11		8	11	mV	
		Output low, I <sub>SINK</sub> = 100μA	140	190		140	190		
		Output high, no load	4.1	4.3		4.1	4.3	V	
		Output high, 2kΩ to GND	3.3	3.8		3.3	3.8		
Supply Current per Amplifier	I <sub>S</sub>		14	21		15	24	μA	

# 17 $\mu$ A Max, Dual/Quad, Single-Supply, Precision Op Amps

## ELECTRICAL CHARACTERISTICS: 5V

( $V_S = 5V$ ,  $0V$ ,  $V_{CM} = 0.1V$ ,  $V_O = 1.4V$ ,  $T_A = -40^\circ C$  to  $+85^\circ C$ , unless otherwise noted.)

PARAMETER	SYMBOL	CONDITIONS	MAX478EP MAX479EP			MAX478ES MAX479ES			UNITS
			MIN	TYP	MAX	MIN	TYP	MAX	
Input Offset Voltage	$V_{OS}$	MAX478	80	315		150	400	$\mu V$	
		MAX479	80	345		160	530		
Input Offset Voltage Drift	$\frac{\Delta V_{OS}}{\Delta T}$	(Note 1)	0.6	3.0		0.8	4.5	$\mu V/^\circ C$	
Input Offset Current	$I_{OS}$		0.07	0.7		0.07	0.7	nA	
Input Bias Current	$I_B$		4	8		4	8	nA	
Common-Mode Rejection Ratio	CMRR	$V_{CM} = 0.05V$ to $3.2V$	84	98		84	98	dB	
Power-Supply Rejection Ratio	PSRR	$V_S = 3.0V$ to $12V$	86	100		86	100	dB	
Large-Signal Voltage Gain	$A_{VOL}$	$V_O = 0.05V$ to $4V$ , no load (Note 1)	55	350		55	350	V/mV	
		$V_O = 0.05V$ to $3.5V$ , $R_L = 50k\Omega$	35	130		35	130		
Output Voltage Swing	$V_{OUT}$	Output low, no load	9	13		9	13	mV	
		Output low, $I_{SINK} = 100\mu A$	160	220		160	220		
		Output high, no load	3.9	4.2		3.9	4.2	V	
		Output high, $2k\Omega$ to GND	3.0	3.7		3.0	3.7		
Supply Current per Amplifier	$I_S$		15	27		15	27	$\mu A$	

# 17 $\mu$ A Max, Dual/Quad, Single-Supply, Precision Op Amps

**MAX478/MAX479**
**ELECTRICAL CHARACTERISTICS: 3V**
*(V<sub>S</sub> = 3V, 0V, V<sub>CM</sub> = 0.1V, V<sub>O</sub> = 0.8V, T<sub>A</sub> = +25°C, unless otherwise noted.)*

PARAMETER	SYMBOL	CONDITIONS	MAX478AC MAX479AC			MAX478C/E MAX479C/E			UNITS
			MIN	TYP	MAX	MIN	TYP	MAX	
Input Offset Voltage	V <sub>OS</sub>	MAX478ACP/CP/EP	30	90		40	140	$\mu$ V	
		MAX479ACP/CP/EP	35	120		40	170		
		MAX478CS/ES				80	200		
		MAX479CS/ES				90	270		
Input Offset Current	I <sub>OS</sub>		0.05		0.05		nA		
Input Bias Current	I <sub>B</sub>		3		3		nA		
Input Noise Voltage	e <sub>N</sub>	0.1Hz to 10Hz		1.0		1.0	$\mu$ V <sub>p-p</sub>		
Input Voltage Range	V <sub>IN (CM)</sub>	Upper limit	1.7	1.9		1.7	1.9	V	
		Lower limit	0	-0.3		0	-0.3		
Common-Mode Rejection Ratio	CMRR	V <sub>CM</sub> = 0V to 1.7V	93	103		90	102	dB	
Power-Supply Rejection Ratio	PSRR	V <sub>S</sub> = 2.2V to 12V	94	104		92	104	dB	
Large-Signal Voltage Gain	A <sub>VOL</sub>	V <sub>O</sub> = 0.03V to 2V, no load (Note 1)	100	600		100	600	V/mV	
		V <sub>O</sub> = 0.03V to 1.5V, R <sub>L</sub> = 50k $\Omega$	30	180		30	180		
Output Voltage Swing	V <sub>OUT</sub>	Output low, no load		6	9		6	9	mV
		Output low, 2k $\Omega$ to GND		0.2	0.6		0.2	0.6	
		Output high, no load		2.2	2.4		2.2	2.4	V
		Output high, 2k $\Omega$ to GND		1.8	2.0		1.8	2.0	
Gain-Bandwidth Product	GBW	f <sub>O</sub> $\leq$ 5kHz		50		50		kHz	
Supply Current per Amplifier	I <sub>S</sub>		12	17		13	20	$\mu$ A	
Minimum Supply Voltage	V <sub>S</sub>			2.2		2.2		V	
		With 300 $\mu$ V V <sub>OS</sub> degradation		1.7		1.7			

# 17 $\mu$ A Max, Dual/Quad, Single-Supply, Precision Op Amps

## ELECTRICAL CHARACTERISTICS: $\pm 15$ V

( $V_S = \pm 15$ V,  $T_A = +25^\circ\text{C}$ , unless otherwise noted.)

PARAMETER	SYMBOL	CONDITIONS	MAX478AC MAX479AC			MAX478C/E MAX479C/E			UNITS
			MIN	TYP	MAX	MIN	TYP	MAX	
Input Offset Voltage	$V_{OS}$		80	350		100	480	$\mu\text{V}$	
Input Offset Current	$I_{OS}$		0.05	0.25		0.05	0.35	nA	
Input Bias Current	$I_B$		3	5		3	6	nA	
Input Voltage Range	$V_{IN(CM)}$	Upper limit	13.5	13.9		13.5	13.9	V	
		Lower limit	-15.0	-15.3		-15.0	-15.3		
Common-Mode Rejection Ratio	CMRR	$V_{CM} = +13.5\text{V}, -15\text{V}$	97	106		94	106	dB	
Power-Supply Rejection Ratio	PSRR	$V_S = 5\text{V}, 0\text{V to } \pm 15\text{V}$	96	112		94	112	dB	
Large-Signal Voltage Gain	$A_{VOL}$	$V_O = \pm 10\text{V}, R_L = 50\text{k}\Omega$	300	1200		250	1000	V/mV	
		$V_O = \pm 10\text{V}, \text{no load}$	600	2500		400	2500		
Output Voltage Swing	$V_{OUT}$	$R_L = 50\text{k}\Omega$	$\pm 13.0$	$\pm 14.2$		$\pm 13.0$	$\pm 14.2$	V	
		$R_L = 2\text{k}\Omega$	$\pm 11.0$	$\pm 12.7$		$\pm 11.0$	$\pm 12.7$		
Slew Rate	SR	$A_V = +1\text{V}, C_L = 15\text{pF}$	0.02	0.04		0.02	0.04	V/ $\mu\text{s}$	
Gain-Bandwidth Product	GBW	$f_O \leq 5\text{kHz}$	85			85		kHz	
Supply Current per Amplifier	$I_S$		16	21		17	25	$\mu\text{A}$	

# 17μA Max, Dual/Quad, Single-Supply, Precision Op Amps

MAX478/MAX479

## ELECTRICAL CHARACTERISTICS: ±15V

(V<sub>S</sub> = ±15V, T<sub>A</sub> = 0°C to +70°C, unless otherwise noted.)

PARAMETER	SYMBOL	CONDITIONS	MAX478AC MAX479AC			MAX478C MAX479C			UNITS
			MIN	TYP	MAX	MIN	TYP	MAX	
Input Offset Voltage	V <sub>OS</sub>		100	480		130	660		μV
Input Offset-Voltage Drift	$\frac{\Delta V_{OS}}{\Delta T}$	MAX47_ACP/CP (Note 1)	0.6	2.8		0.7	4.0		μV/°C
		MAX47_CS (Note 1)				0.9	5.5		
Input Offset Current	I <sub>OS</sub>		0.06	0.35		0.06	0.35		nA
Input Bias Current	I <sub>B</sub>		3	6		3	7		nA
Large-Signal Voltage Gain	A <sub>VOL</sub>	V <sub>O</sub> = ±10V, R <sub>L</sub> = 50kΩ	200	800		150	750		V/mV
Common-Mode Rejection Ratio	CMRR	V <sub>CM</sub> = +13V, -15V	94	104		91	104		dB
Power-Supply Rejection Ratio	PSRR	V <sub>S</sub> = 5V, 0V to ±15V	93	110		91	110		dB
Output Voltage Swing	V <sub>OUT</sub>	R <sub>L</sub> = 5kΩ	±11.0	±13.5		±11.0	±13.5		V
Supply Current per Amplifier	I <sub>S</sub>		17	24		18	28		μA

# 17 $\mu$ A Max, Dual/Quad, Single-Supply, Precision Op Amps

## ELECTRICAL CHARACTERISTICS: $\pm 15$ V

( $V_S = \pm 15$ V,  $T_A = -40^\circ\text{C}$  to  $+85^\circ\text{C}$ , unless otherwise noted.)

PARAMETER	SYMBOL	CONDITIONS	MAX478EP MAX479EP			MAX478ES MAX479ES			UNITS
			MIN	TYP	MAX	MIN	TYP	MAX	
Input Offset Voltage	$V_{OS}$		130	740		130	740	$\mu\text{V}$	
Input Offset-Voltage Drift	$\frac{\Delta V_{OS}}{\Delta T}$	(Note 1)	0.7	4.0		0.9	5.5	$\mu\text{V}/^\circ\text{C}$	
Input Offset Current	$I_{OS}$		0.07	0.70		0.07	0.70	nA	
Input Bias Current	$I_B$		4	8		4	8	nA	
Large-Signal Voltage Gain	$A_{VOL}$	$V_O = \pm 10\text{V}$ , $R_L = 50\text{k}\Omega$	100	500		100	500	V/mV	
Common-Mode Rejection Ratio	CMRR	$V_{CM} = +13\text{V}$ , $-14.9\text{V}$	88	103		88	103	dB	
Power-Supply Rejection Ratio	PSRR	$V_S = 5\text{V}$ , $0\text{V}$ to $\pm 15\text{V}$	88	109		88	109	dB	
Output Voltage Swing	$V_{OUT}$	$R_L = 5\text{k}\Omega$	$\pm 11.0$	$\pm 13.5$		$\pm 11.0$	$\pm 13.5$	V	
Supply Current per Amplifier	$I_S$		19	30		19	30	$\mu\text{A}$	

**Note 1:** Guaranteed by design.

**Note 2:** Power-supply rejection ratio is measured at the minimum supply voltage. The op amps actually work at 1.7V supply, but with additional input offset-voltage skew.



# 17 $\mu$ A Max, Dual/Quad, Single-Supply, Precision Op Amps

## Typical Operating Characteristics

MAX478/MAX479

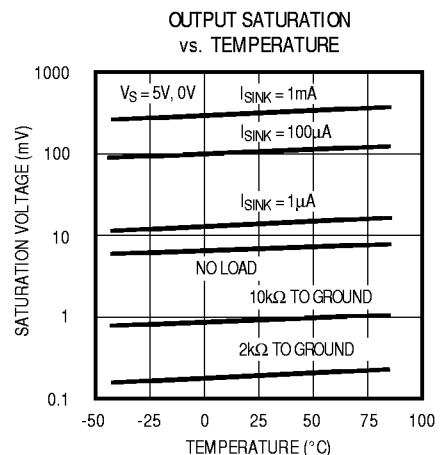
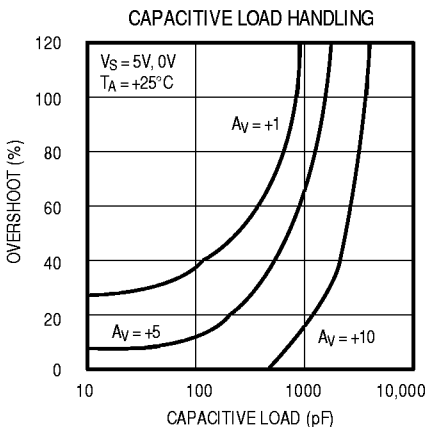
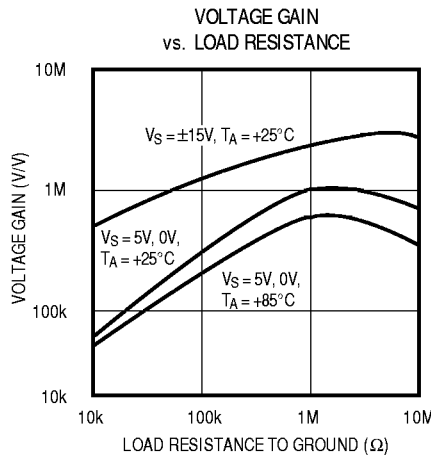
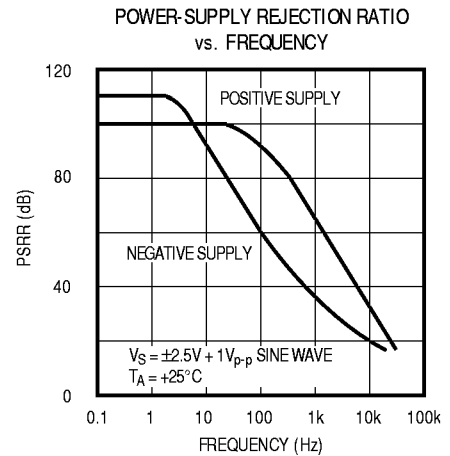
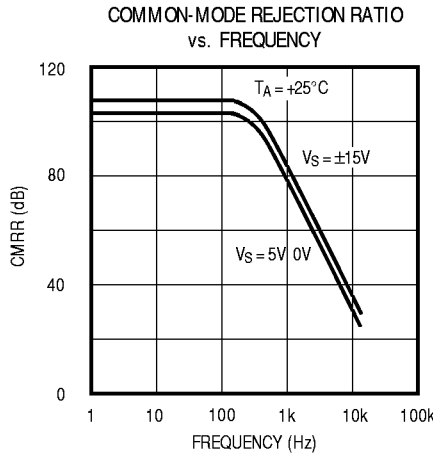
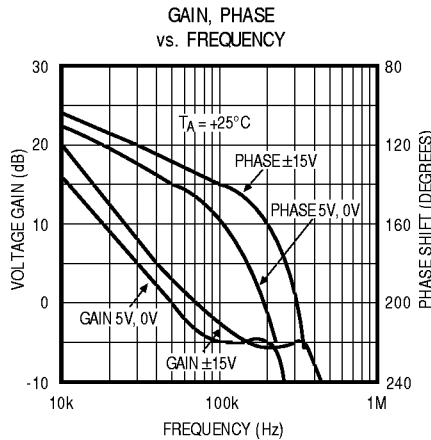
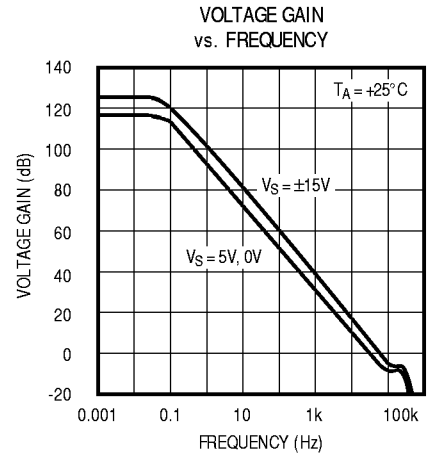
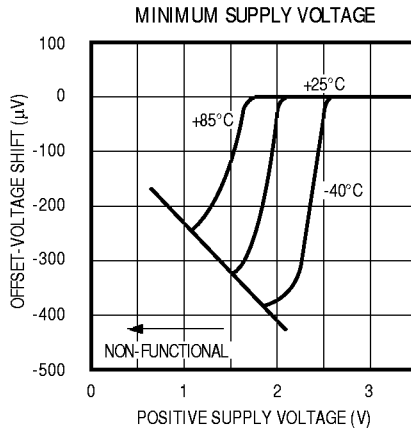
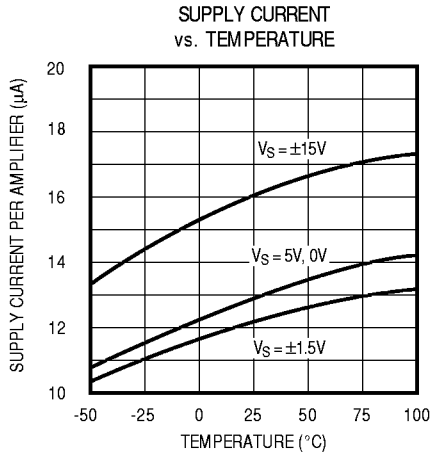

# 17 $\mu$ A Max, Dual/Quad, Single-Supply, Precision Op Amps

Typical Operating Characteristics (continued)

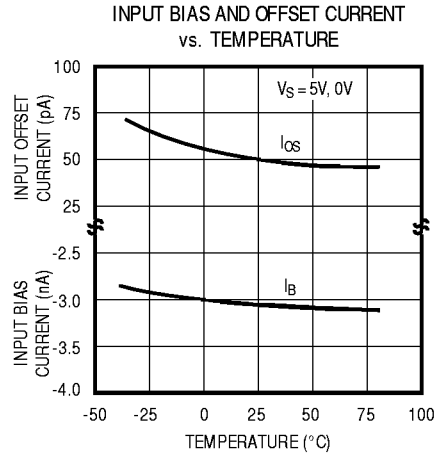
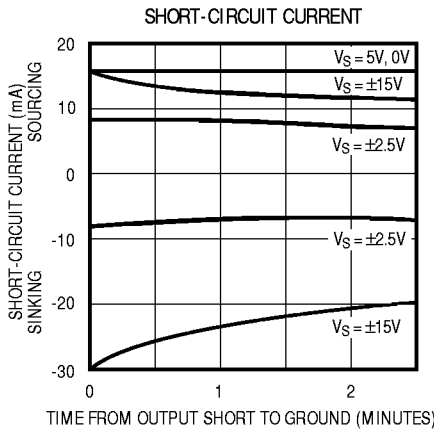
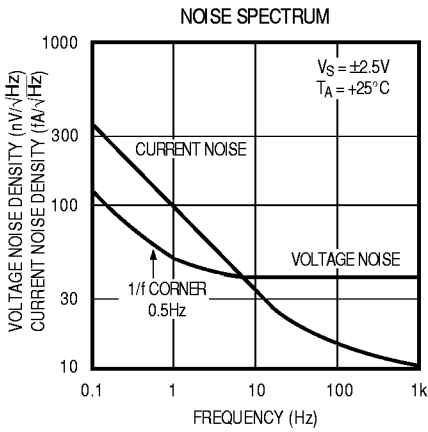

LARGE-SIGNAL TRANSIENT RESPONSE  
 $V_S = \pm 15V$

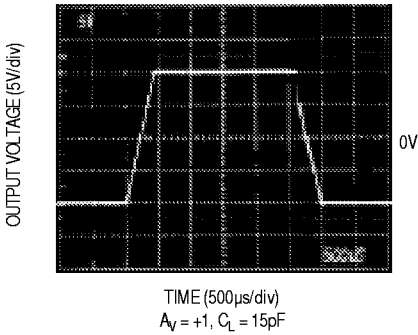

LARGE-SIGNAL TRANSIENT RESPONSE  
 $V_S = 5V, 0V$

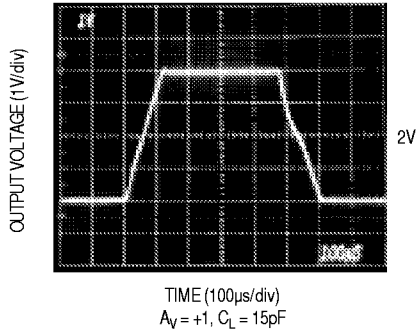

SMALL-SIGNAL TRANSIENT RESPONSE  
 $V_S = \pm 2.5V$

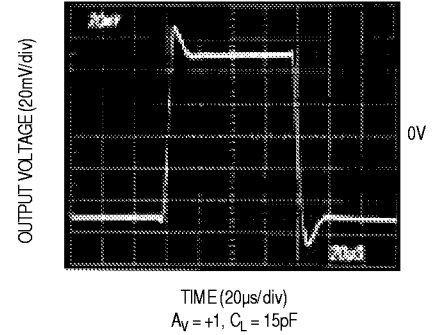

SMALL-SIGNAL TRANSIENT RESPONSE  
 $V_S = 5V, 0V$

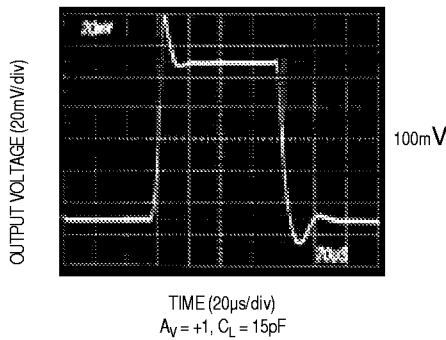

SMALL-SIGNAL TRANSIENT RESPONSE  
 $V_S = \pm 15V$

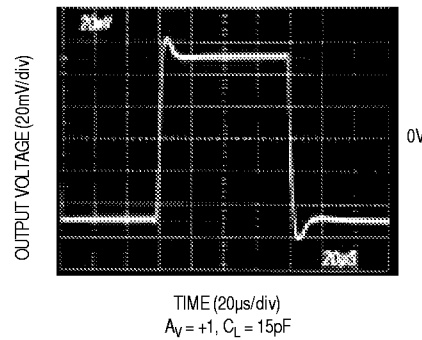

# 17µA Max, Dual/Quad, Single-Supply, Precision Op Amps

MAX478/MAX479

Typical Application Circuit

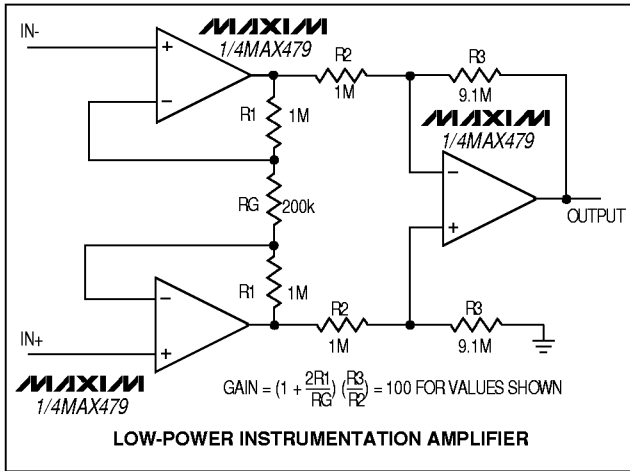

Chip Topography

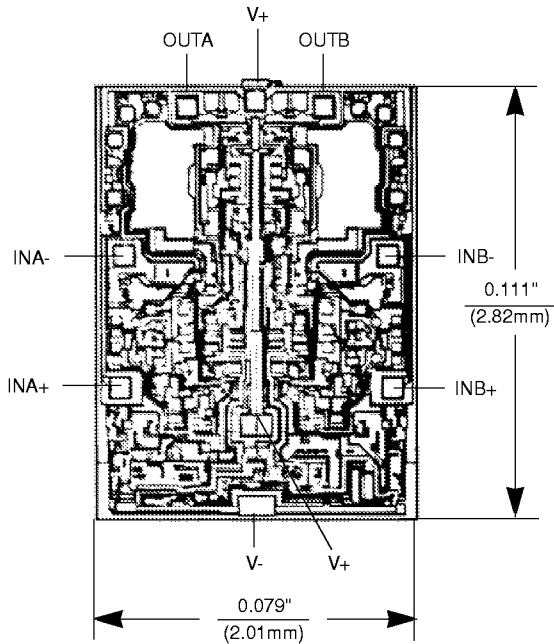

Package Information

	INCHES		MILLIMETERS	
	MIN	MAX	MIN	MAX
A	0.053	0.069	1.35	1.75
A1	0.004	0.010	0.10	0.25
E	0.014	0.019	0.35	0.49
C	0.007	0.010	0.19	0.25
e	0.050		1.27	
E	0.150	0.157	3.80	4.00
H	0.223	0.244	5.80	6.20
F	0.010	0.020	0.25	0.50
L	0.015	0.050	0.40	1.27

	INCHES		MILLIMETERS		N	MS012
	MIN	MAX	MIN	MAX		
D	0.139	0.197	4.80	5.00	8	A
D	0.337	0.344	8.55	8.75	14	B
D	0.385	0.394	9.80	10.00	16	C

NOTE:  
 1. DICE DO NOT INCLUDE MOLD FLASH  
 2. MOLD FLASH OR PROTRUSION NOT TO EXCEED .15mm (.006")  
 3. LEAD TO BE COPLANAR WITHIN .102mm (.004")  
 4. CONTROLLING DIMENSION: MILLIMETER  
 5. MEETS JEDEC M-2012-KX AS SHOWN IN ABOVE TABLE  
 6. N = NUMBER OF PINS

**MAXIM** PACKAGE FAMILY OUTLINE: SOIC .150\* 1 21-0041 A

# 17µA Max, Dual/Quad, Single-Supply, Precision Op Amps

## Package Information (continued)

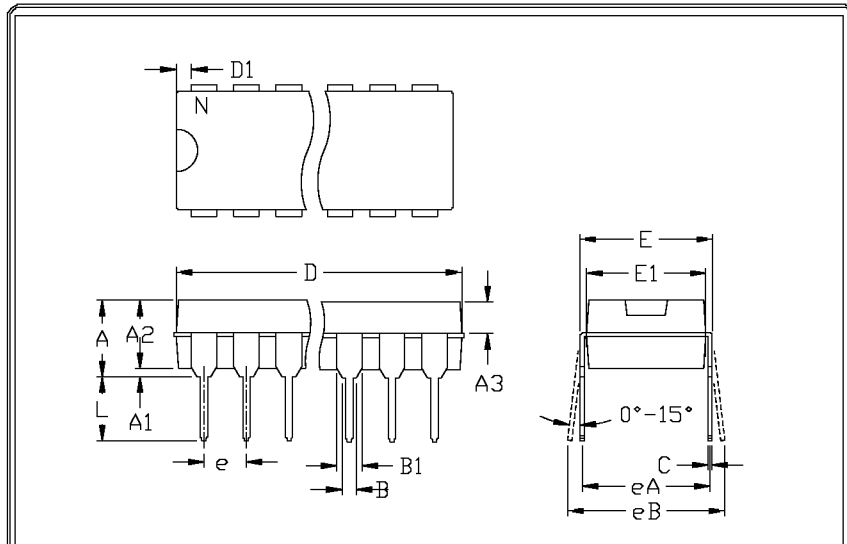

	INCHES		MILLIMETERS	
	MIN	MAX	MIN	MAX
A	---	0.200	---	5.08
A1	0.015	---	0.38	---
A2	0.125	0.175	3.18	4.45
A3	0.055	0.080	1.40	2.03
B	0.016	0.022	0.41	0.56
B1	0.045	0.065	1.14	1.65
C	0.008	0.012	0.20	0.30
D1	0.005	0.080	0.13	2.03
E	0.300	0.325	7.62	8.26
E1	0.240	0.310	6.10	7.87
e	0.100	---	2.54	---
eA	0.300	---	7.62	---
eB	---	0.400	---	10.16
L	0.115	0.150	2.92	3.81

	INCHES		MILLIMETERS		N	MS001
	MIN	MAX	MIN	MAX		
D	0.348	0.390	8.84	9.91	8	AB
D	0.735	0.765	18.67	19.43	14	AC
D	0.745	0.765	18.92	19.43	16	AA
D	0.885	0.915	22.48	23.24	18	AD
D	1.015	1.045	25.78	26.54	20	AE
D	1.14	1.265	28.96	32.13	24	AF
D	1.360	1.380	34.54	35.05	28	*5

- NOTES:
1. D&E DO NOT INCLUDE MOLD FLASH
  2. MOLD FLASH OR PROTRUSIONS NOT TO EXCEED .15mm (.006")
  3. CONTROLLING DIMENSION: MILLIMETER
  4. MEETS JEDEC MS001-XX AS SHOWN IN ABOVE TABLE
  5. SIMILAR TO JEDEC MO-058AB
  6. N = NUMBER OF PINS

PACKAGE FAMILY OUTLINE: PDIP .300"  $\frac{1}{1}$  21-0043 A  
20 SAN GABRIEL DR. SUNNYVALE CA 94086 FAX 408 737 7791 PROPRIETARY INFORMATION TITLE DOCUMENT CONTROL NUMBER REV

Maxim cannot assume responsibility for use of any circuitry other than circuitry entirely embodied in a Maxim product. No circuit patent licenses are implied. Maxim reserves the right to change the circuitry and specifications without notice at any time.

12 \_\_\_\_\_ Maxim Integrated Products, 120 San Gabriel Drive, Sunnyvale, CA 94086 408-737-7600