

## HEIDI-W

~30° wide beam optimized for LUXEON Rebel ES

### SPECIFICATION:

Dimensions	Ø 21.6 mm
Height	11.7 mm
Fastening	tape, pin
ROHS compliant	yes ⓘ

### MATERIALS:

Component	Type	Material	Colour	Finish
HEIDI-W	Single lens	PMMA	clear	
HEIDI-TAPE	Tape	Acrylic foam	black	

### ORDERING INFORMATION:

Component		Qty in box	MOQ	MPQ	Box weight (kg)
CA12538_HEIDI-W	Single lens	3264	204	204	11.1
» Box size: 480 x 280 x 300 mm					



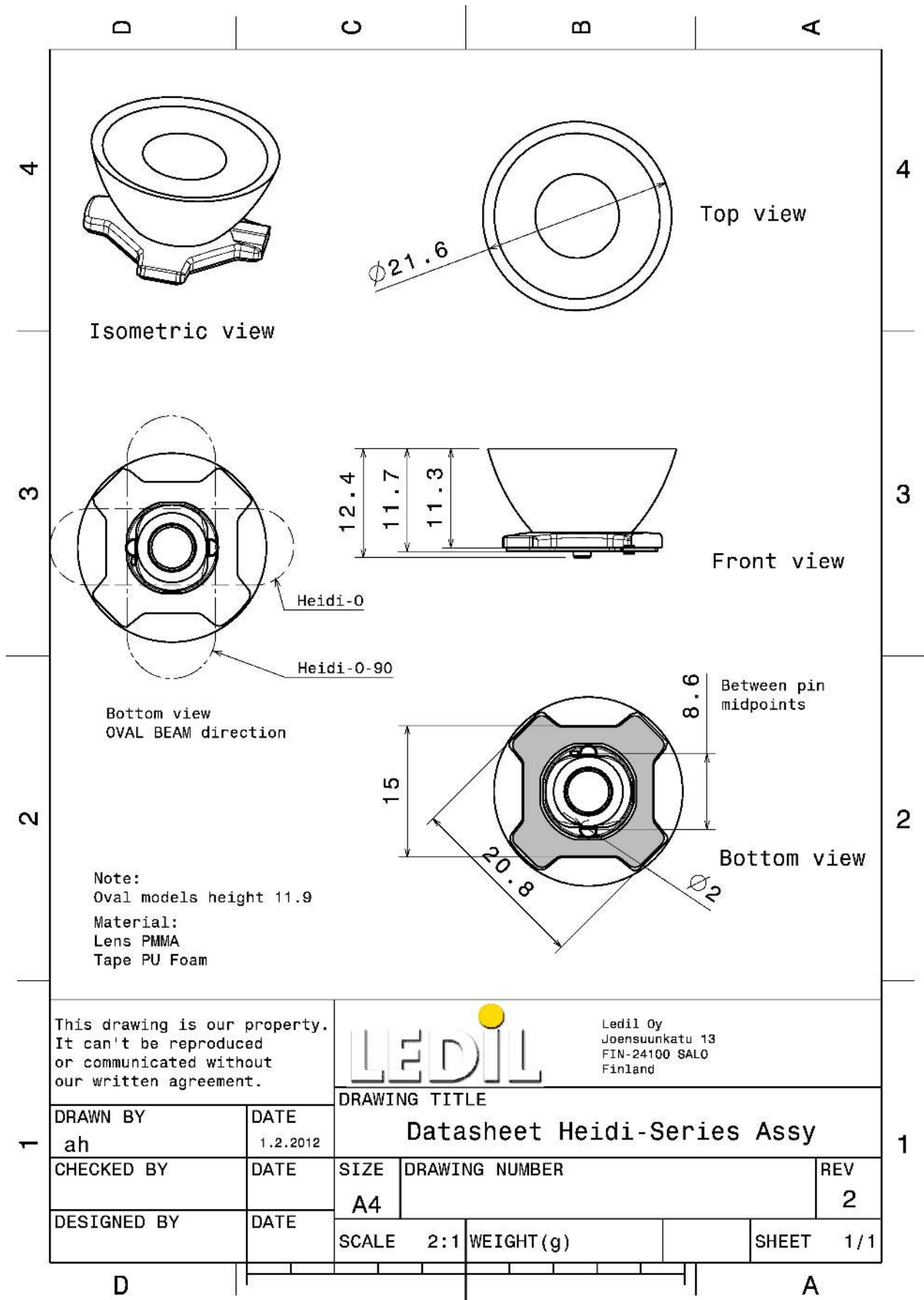







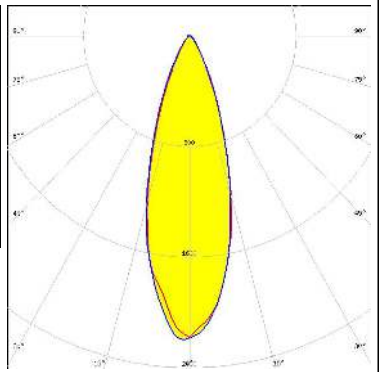

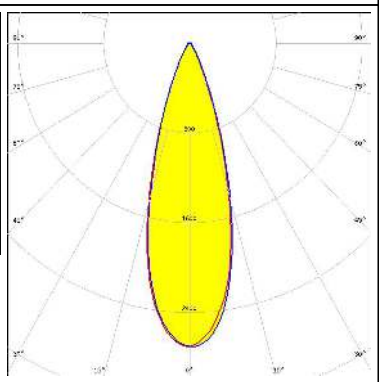

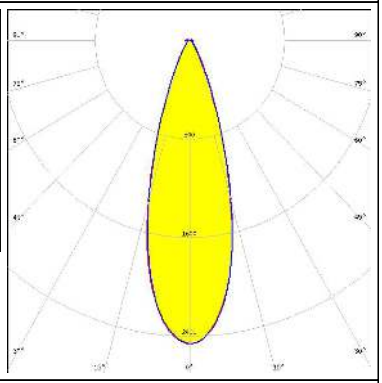
This drawing is our property. It can't be reproduced or communicated without our written agreement.				Ledil Oy Joensuunkatu 13 FIN-24100 SALO Finland	
DRAWN BY ah		DATE 1.2.2012		DRAWING TITLE Datasheet Heidi-Series Ass'y	
CHECKED BY		DATE		SIZE A4	DRAWING NUMBER
DESIGNED BY		DATE		SCALE 2:1	WEIGHT (g)
				SHEET 1/1	REV 2

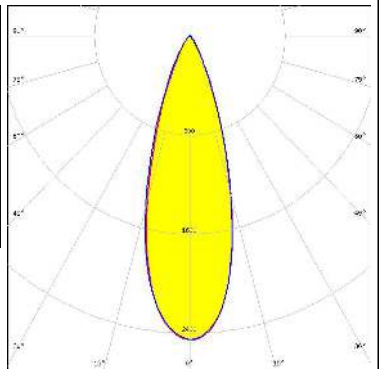
See also our general installation guide: [www.ledil.com/installation\\_guide](http://www.ledil.com/installation_guide)

#### OPTICAL RESULTS (MEASURED):

<p><b>CREE</b> ⇄ <b>LED</b></p> <p>LED XHP35 HD            FWHM / FWTM 32.0° / 62.0°            Efficiency 84 %            Peak intensity 2.4 cd/m            LEDs/each optic 1            Light colour White            Required components:</p>		
<p><b>CREE</b> ⇄ <b>LED</b></p> <p>LED XHP35 HI            FWHM / FWTM 31.0° / 54.0°            Efficiency 94 %            Peak intensity 2.7 cd/m            LEDs/each optic 1            Light colour White            Required components:</p>		
<p><b>CREE</b> ⇄ <b>LED</b></p> <p>LED XP-G3            FWHM / FWTM 32.0° / 56.0°            Efficiency 94 %            Peak intensity 2.5 cd/m            LEDs/each optic 1            Light colour White            Required components:</p>		
<p><b>CREE</b> ⇄ <b>LED</b></p> <p>LED XP-L HD            FWHM / FWTM 33.0° / 57.0°            Efficiency 87 %            Peak intensity 2.5 cd/m            LEDs/each optic 1            Light colour White            Required components:</p>		

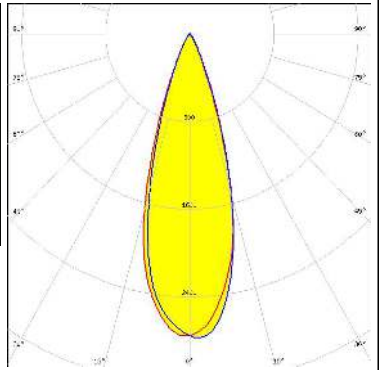
### OPTICAL RESULTS (MEASURED):

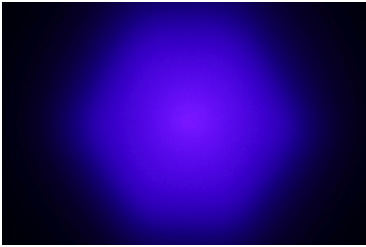
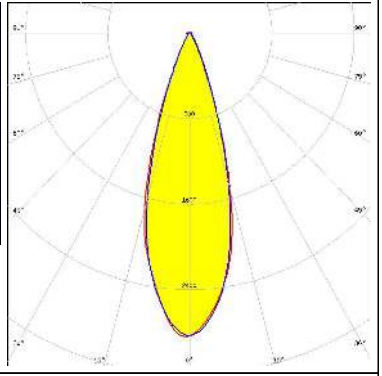
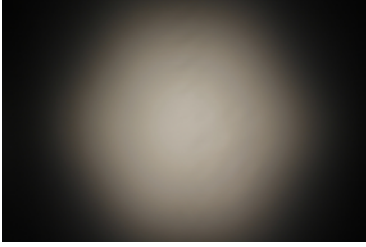
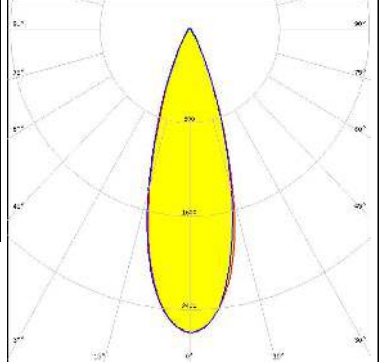

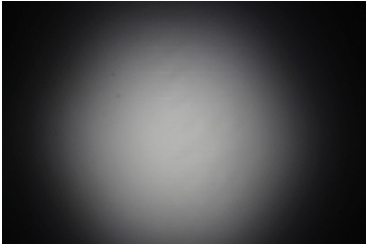
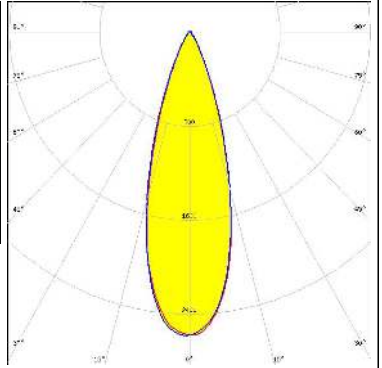
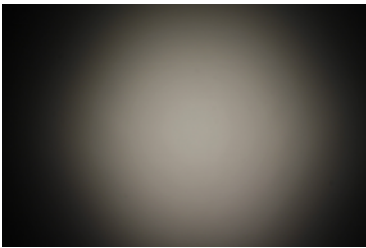
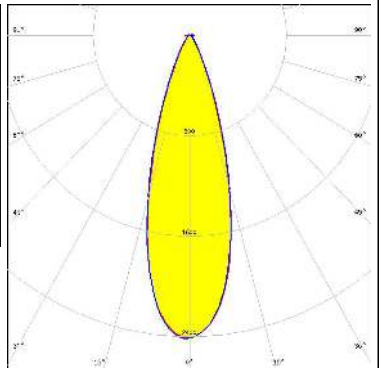
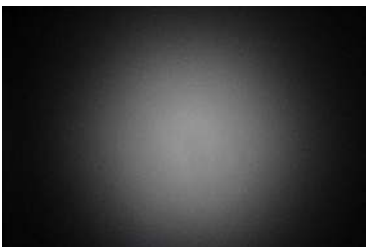
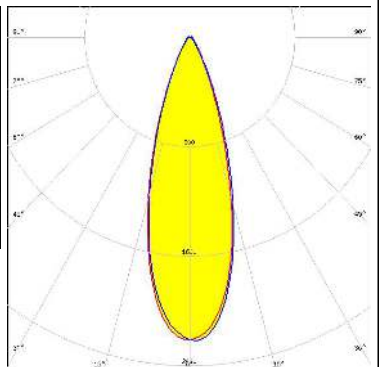
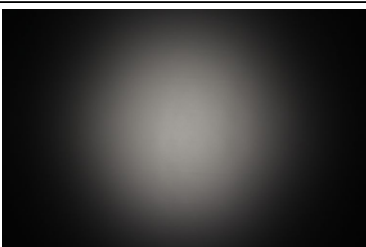
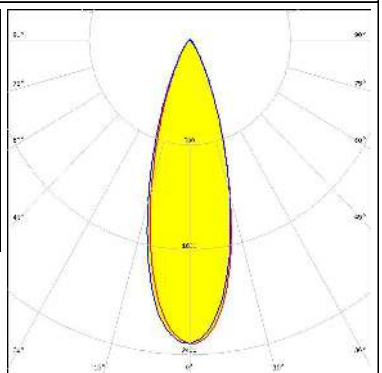

<p><b>LUMILEDS</b></p> <p>LED LUXEON Rebel</p> <p>FWHM / FWTM 32.0° / 51.0°</p> <p>Efficiency 87 %</p> <p>Peak intensity 2.8 cd/m</p> <p>LEDs/each optic 1</p> <p>Light colour White</p> <p>Required components:</p>		
<p><b>LUMILEDS</b></p> <p>LED LUXEON Rebel ES</p> <p>FWHM / FWTM 32.0° / 54.0°</p> <p>Efficiency 87 %</p> <p>Peak intensity 2.8 cd/m</p> <p>LEDs/each optic 1</p> <p>Light colour White</p> <p>Required components:</p>		
<p><b>LUMINUS</b></p> <p>LED SST-10-B130</p> <p>FWHM / FWTM 33.0° / 51.0°</p> <p>Efficiency 93 %</p> <p>Peak intensity 2.8 cd/m</p> <p>LEDs/each optic 1</p> <p>Light colour Blue</p> <p>Required components:</p>		
<p><b>NICHIA</b></p> <p>LED NVSW219D</p> <p>FWHM / FWTM 32.0° / 54.0°</p> <p>Efficiency 94 %</p> <p>Peak intensity 2.6 cd/m</p> <p>LEDs/each optic 1</p> <p>Light colour White</p> <p>Required components:</p>		

#### OPTICAL RESULTS (MEASURED):

<p><b>NICHIA</b></p> <p>LED NVSW319B            FWHM / FWTM 32.0° / 56.0°            Efficiency 94 %            Peak intensity 2.6 cd/lm            LEDs/each optic 1            Light colour White            Required components:</p>		
<p><b>NICHIA</b></p> <p>LED NVSW3x9A            FWHM / FWTM 31.0° / 55.0°            Efficiency 90 %            Peak intensity 2.4 cd/lm            LEDs/each optic 1            Light colour White            Required components:</p>		
<p><b>NICHIA</b></p> <p>LED NVSW519A            FWHM / FWTM 32.0° / 59.0°            Efficiency 91 %            Peak intensity 2.2 cd/lm            LEDs/each optic 1            Light colour White            Required components:</p>		
<p><b>NICHIA</b></p> <p>LED NWSx229A            FWHM / FWTM 31.0° / 57.0°            Efficiency 83 %            Peak intensity 2.3 cd/lm            LEDs/each optic 1            Light colour White            Required components:</p>		

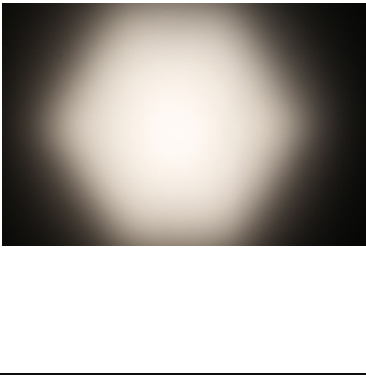
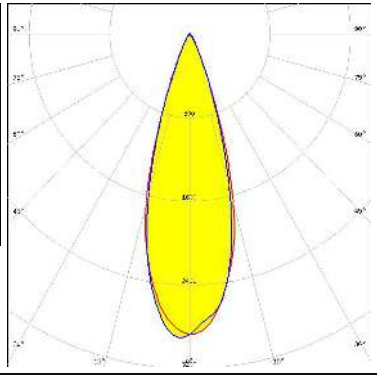

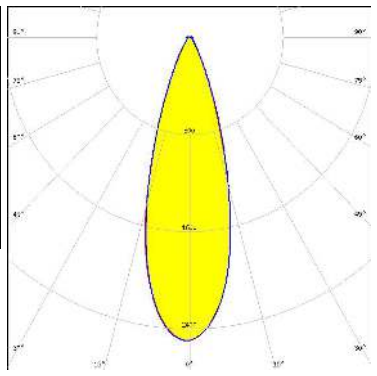
### OPTICAL RESULTS (MEASURED):

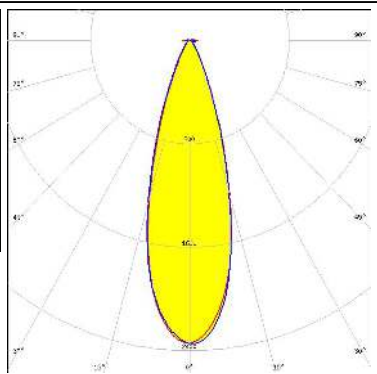
<p><b>OSRAM</b> Opto Semiconductors</p> <p>LED OSLON SSL 150</p> <p>FWHM / FWTM 32.0° / 49.0°</p> <p>Efficiency 86 %</p> <p>Peak intensity 2.9 cd/m</p> <p>LEDs/each optic 1</p> <p>Light colour White</p> <p>Required components:</p>		
<p><b>SEOUL SEMICONDUCTOR</b></p> <p>LED Z5M3</p> <p>FWHM / FWTM 32.0° / 56.0°</p> <p>Efficiency 94 %</p> <p>Peak intensity 2.5 cd/m</p> <p>LEDs/each optic 1</p> <p>Light colour White</p> <p>Required components:</p>		
<p><b>SEOUL SEMICONDUCTOR</b></p> <p>LED Z8Y22P</p> <p>FWHM / FWTM 31.0° / 55.0°</p> <p>Efficiency 92 %</p> <p>Peak intensity 2.3 cd/m</p> <p>LEDs/each optic 1</p> <p>Light colour White</p> <p>Required components:</p>		

#### OPTICAL RESULTS (SIMULATED):

##### CREE LED

LED XP-G2 HE  
 FWHM / FWTM 32.0° / 55.0°  
 Efficiency 93 %  
 Peak intensity 2.6 cd/lm  
 LEDs/each optic 1  
 Light colour White  
 Required components:

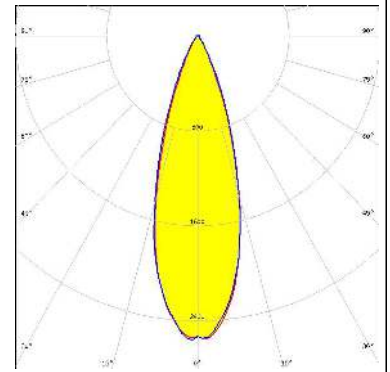

##### CREE LED

LED XP-L2  
 FWHM / FWTM 32.0° / 59.0°  
 Efficiency 91 %  
 Peak intensity 2.4 cd/lm  
 LEDs/each optic 1  
 Light colour White  
 Required components:

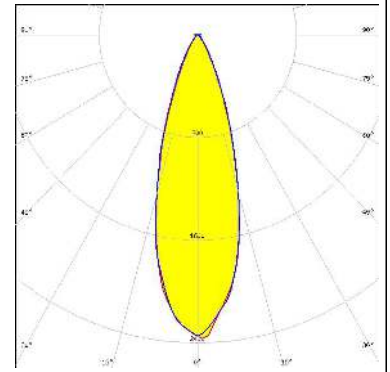

##### CREE LED

LED XP-L2  
 FWHM / FWTM 32.0° / 59.0°  
 Efficiency 91 %  
 Peak intensity 2.4 cd/lm  
 LEDs/each optic 1  
 Light colour White  
 Required components:

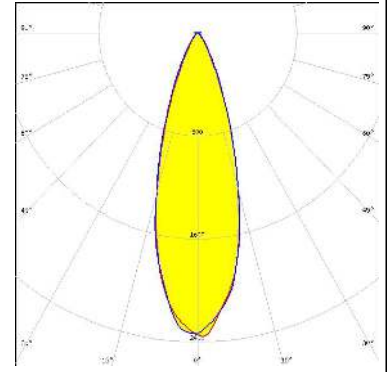

##### LUMILEDS

LED LUXEON A  
 FWHM / FWTM 31.0°  
 Efficiency %  
 LEDs/each optic 1  
 Light colour White  
 Required components:

## OPTICAL RESULTS (SIMULATED):

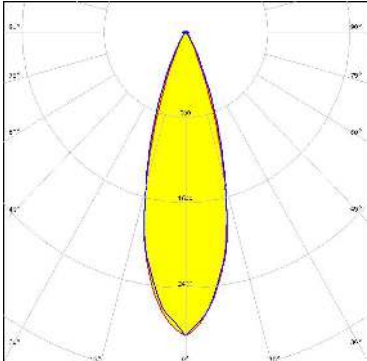



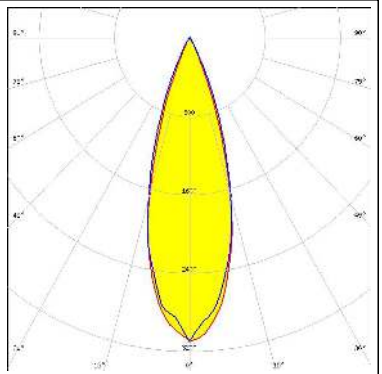
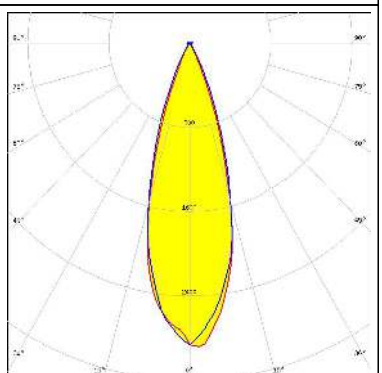
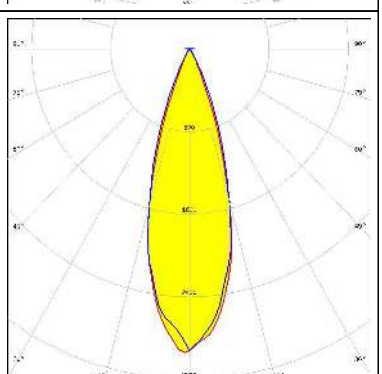
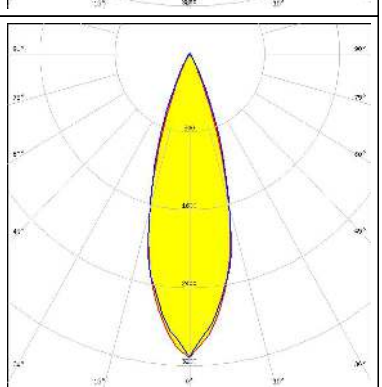

<p><b>LUMILEDS</b></p> <p>LED: LUXEON HL2Z</p> <p>FWHM / FWTM: 32.0° / 54.0°</p> <p>Efficiency: 93 %</p> <p>Peak intensity: 2.8 cd/lm</p> <p>LEDs/each optic: 1</p> <p>Light colour: White</p> <p>Required components:</p>	
<p><b>LUMILEDS</b></p> <p>LED: LUXEON IR Domed 150</p> <p>FWHM / FWTM: 31.0° / 50.0°</p> <p>Efficiency: 93 %</p> <p>LEDs/each optic: 1</p> <p>Light colour: White</p> <p>Required components:</p>	
<p><b>LUMILEDS</b></p> <p>LED: LUXEON IR Domed 90</p> <p>FWHM / FWTM: 31.0° / 52.0°</p> <p>Efficiency: 94 %</p> <p>LEDs/each optic: 1</p> <p>Light colour: White</p> <p>Required components:</p>	
<p><b>LUMILEDS</b></p> <p>LED: LUXEON R</p> <p>FWHM / FWTM: 32.0°</p> <p>Efficiency: %</p> <p>LEDs/each optic: 1</p> <p>Light colour: White</p> <p>Required components:</p>	

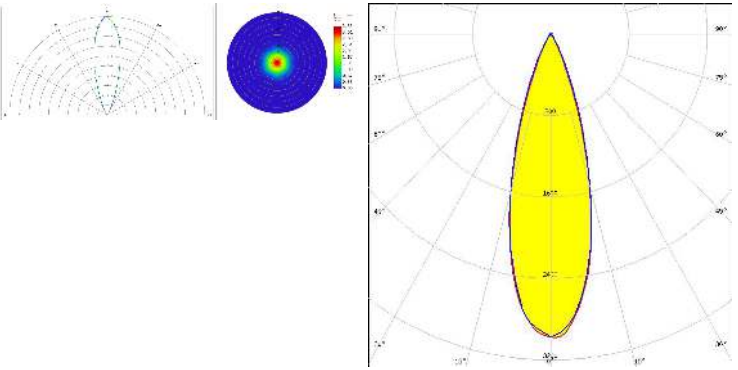

#### OPTICAL RESULTS (SIMULATED):

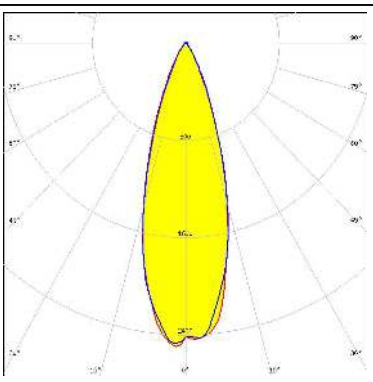
<p><b>LUMILEDS</b></p> <p>LED LUXEON SunPlus 20 Line (120 deg)</p> <p>FWHM / FWTM 31.0° / 52.0°</p> <p>Efficiency 95 %</p> <p>Peak intensity 3.1 cd/lm</p> <p>LEDs/each optic 1</p> <p>Light colour White</p> <p>Required components:</p>	
<p><b>LUMILEDS</b></p> <p>LED LUXEON SunPlus 20 Line (150 deg)</p> <p>FWHM / FWTM 31.0° / 52.0°</p> <p>Efficiency 91 %</p> <p>Peak intensity 2.9 cd/lm</p> <p>LEDs/each optic 1</p> <p>Light colour White</p> <p>Required components:</p>	
<p><b>LUMILEDS</b></p> <p>LED LUXEON SunPlus 20 Line (150 deg)</p> <p>FWHM / FWTM 31.0° / 51.0°</p> <p>Efficiency 92 %</p> <p>Peak intensity 2.9 cd/lm</p> <p>LEDs/each optic 1</p> <p>Light colour White</p> <p>Required components:</p>	
<p><b>LUMILEDS</b></p> <p>LED LUXEON SunPlus 35 Line</p> <p>FWHM / FWTM 31.0° / 51.0°</p> <p>Efficiency 94 %</p> <p>Peak intensity 3.1 cd/lm</p> <p>LEDs/each optic 1</p> <p>Light colour White</p> <p>Required components:</p>	

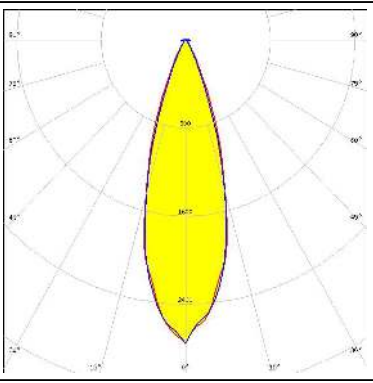
#### OPTICAL RESULTS (SIMULATED):

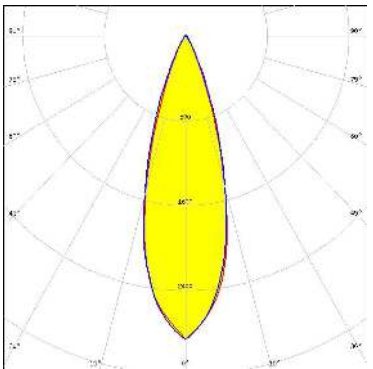
	<p>LED SST-10-B130            FWHM / FWTM 30.0° / 53.0°            Efficiency 95 %            LEDs/each optic 1            Light colour IR            Required components:</p>	
	<p>LED NV4WB35AM            FWHM / FWTM 32.0° / 57.0°            Efficiency 92 %            Peak intensity 2.5 cd/lm            LEDs/each optic 1            Light colour White            Required components:</p>	
	<p>LED NVSxE21A            FWHM / FWTM 31.0° / 53.0°            Efficiency 93 %            Peak intensity 2.8 cd/lm            LEDs/each optic 1            Light colour White            Required components:</p>	
	<p>LED OSCONIQ P 3737 Flat            FWHM / FWTM 32.0° / 55.0°            Efficiency 95 %            Peak intensity 2.9 cd/lm            LEDs/each optic 1            Light colour White            Required components:</p>	

### GENERAL INFORMATION:

NOTE: The typical beam angle will be changed by different color, chip size and chip position tolerance. The typical total beam angle is the full angle measured where the luminous intensity is half of the peak value.

### MATERIALS:

As part of our continuous research and improvement processes, and to ensure the best possible quality and availability of our products, LEDiL reserves the right to change material grades without notice.

### PRODUCT DATA USER AGREEMENT AND DISCLAIMER:

The measured data in the provided downloadable LEDiL Product Datasheets and Mechanical 2D-Drawings is rounded and provided as reference for planning. LEDiL Oy's optical specifications have been verified by conducting performance testing of the products in accordance with the company's quality system. The reported data are averaged results of multiple measurements with typical variation. LEDiL Oy reserves the right to without prior notification make changes and improvements to its products.

LEDiL Oy assumes neither warranty, nor guarantee nor any other liability of any kind for the contents and correctness of the provided data. The provided data has been generated with highest diligence but the provided data may in reality not represent the complete possible variation range of all intrinsic parameters. Therefore, in certain cases a deviation from the provided data could occur.

LEDiL Oy reserves the right to undertake technical changes of its products without further notification which could lead to changes in the provided data. LEDiL Oy assumes no liability of any kind for the possible deviation from any provided data or any other damage resulting from the usage of the provided data.

The user agrees to this disclaimer and user agreement with the download or usage of the provided files.

#### LEDiL Oy

Joensuunkatu 13  
FI-24240 SALO  
Finland

#### LEDiL Inc.

228 West Page Street  
Suite D  
Sycamore IL 60178  
USA

#### Ledil Optics Technology (Shenzhen) Co., Ltd.

# 405 , Block B  
Casic Motor Building  
Shenzhen 518057  
P.R.CHINA

#### Local sales and technical support

[www.ledil.com/  
where\\_to\\_buy](http://www.ledil.com/where_to_buy)

#### Shipping locations

Salo, Finland  
Hong Kong, China

#### Distribution Partners

[www.ledil.com/  
where\\_to\\_buy](http://www.ledil.com/where_to_buy)