

### 1. Features

- Low EMI noise and small footprint using inductor-embedded ferrite substrate
- Wide input voltage range : 2.0 to 5.5V
- Fixed output voltage: 1.0V – 4.0V (factory setting, 100mV step)
- Maximum Load Current: 50mA
- PFM Mode

### 2. Description

The LXDC2MB series is a low power step-down DCDC converter, which is suitable for a space-limited or a noise-sensitive application. The device utilizes an inductor-embedded ferrite substrate, and the substrate eliminates radiated EMI noise and conduction noise efficiently.

By just putting input/output capacitors, it can be used as a LDO replacement. Its low noise feature and easy to assembly feature assures reliable power supply quality.

The device works in PFM mode at each loads and it extends the battery life. The device has an ultra-low quiescent circuit and operates with high efficiency at both light loads and heavy loads.

### 3. Typical Application Circuit

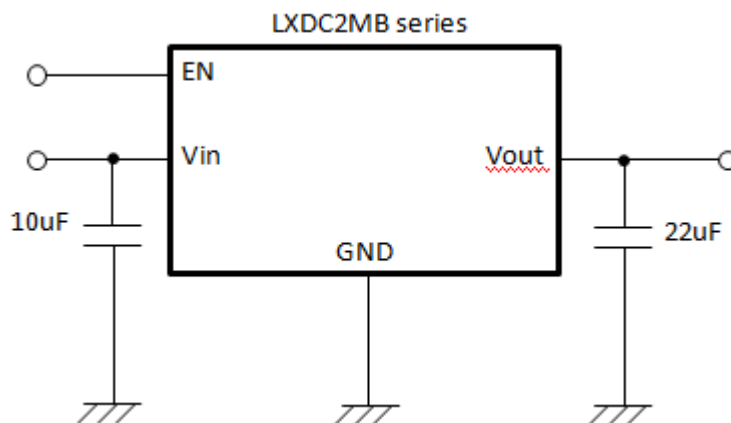

## 4. Mechanical Details

### 4-1 Outline

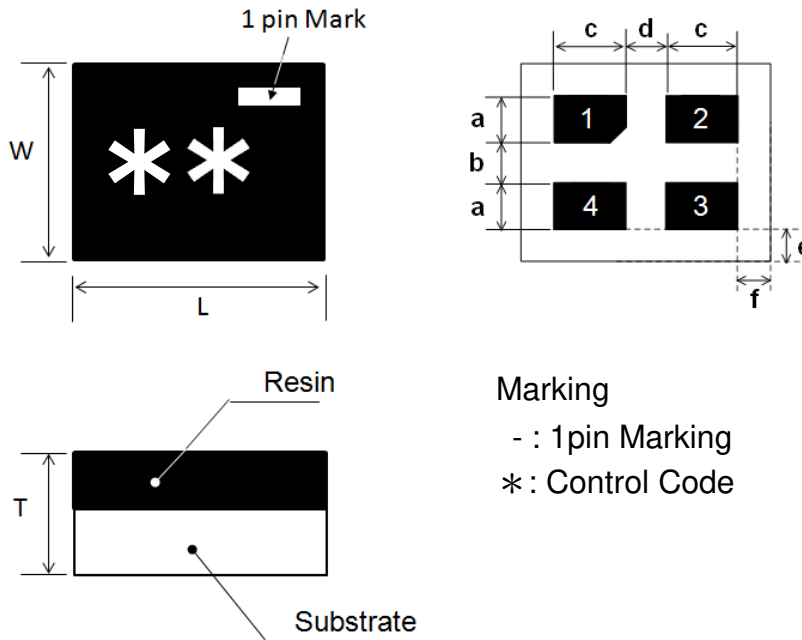

### Marking

- : 1pin Marking
- \* : Control Code

Unit:mm

Mark	Dimension	Mark	Dimension
L	$2.0 \pm 0.2$	a	$0.38 \pm 0.1$
W	$1.6 \pm 0.2$	b	$0.33 \pm 0.1$
T	1.0 max	c	$0.58 \pm 0.1$
		d	$0.32 \pm 0.1$
		e	$0.25 \pm 0.1$
		f	$0.26 \pm 0.1$

### 4-2. Pin Function

Pin No.	Symbol	I/O	Description
1	Vin	Input	Vin pin supplies current to the LXDC2MB internal regulator.
2	EN	Input	This is the ON/OFF control pin of the device. This pin should not be left floating. EN=H: Device ON, EN=L: Device OFF
3	Vout	Output	Regulated voltage output pin. Apply output load between this pin and GND
4	GND	-	Ground pin

**4-3. Functional Block Diagram**

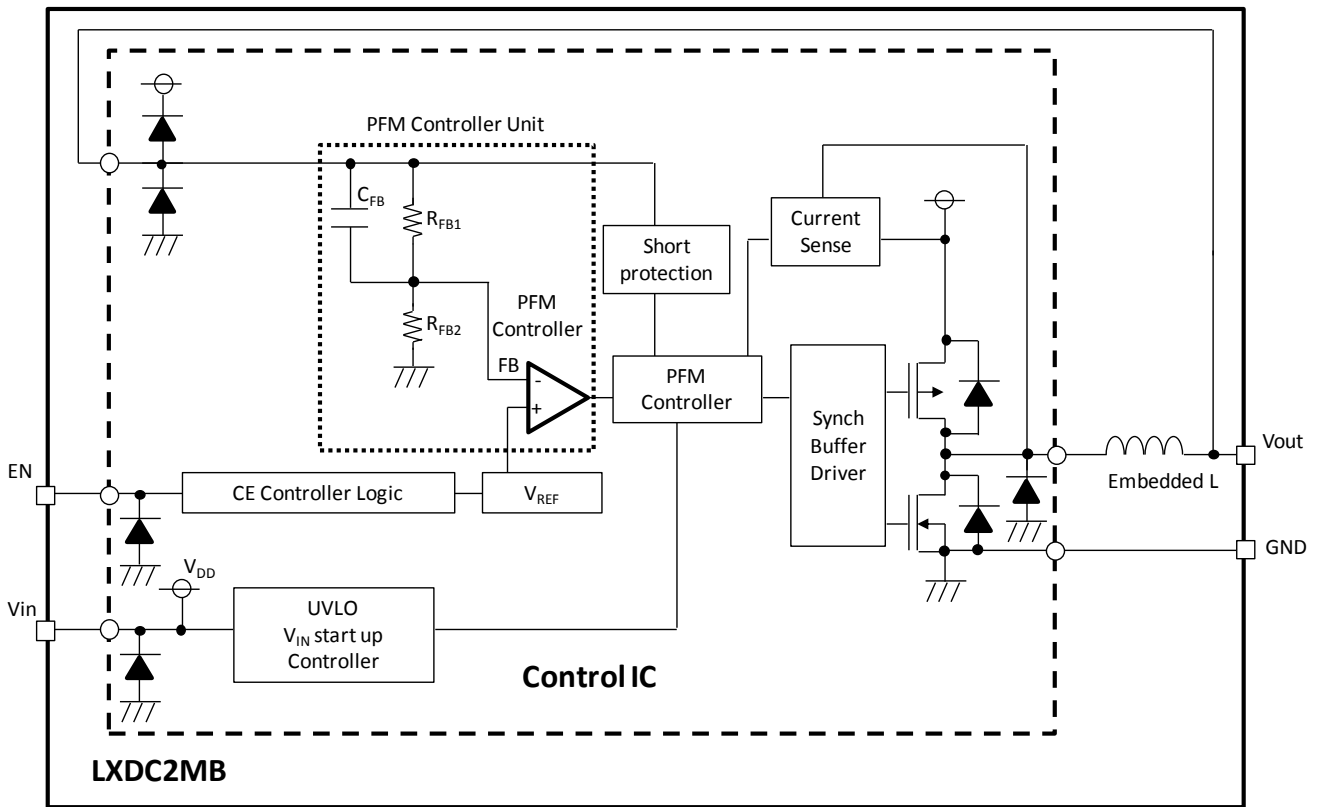

**5. Ordering Information**

Part number	Output Voltage	Device Specific Feature	MOQ
LXDC2MB10G-454	1.0V	Standard Type	T/R, 3000pcs/R
LXDC2MB11G-423	1.1V	Standard Type	T/R, 3000pcs/R
LXDC2MB12G-424	1.2V	Standard Type	T/R, 3000pcs/R
LXDC2MB15G-456	1.5V	Standard Type	T/R, 3000pcs/R
LXDC2MB18G-425	1.8V	Standard Type	T/R, 3000pcs/R
LXDC2MB25G-426	2.5V	Standard Type	T/R, 3000pcs/R
LXDC2MB30G-427	3.0V	Standard Type	T/R, 3000pcs/R
LXDC2MB33G-428	3.3V	Standard Type	T/R, 3000pcs/R

# Output voltage can be set 0.1V step from 1.0V to 4.0V. Please ask Murata representative.

**6. Electrical Specification**

**6-1 Absolute maximum ratings**

Parameter	symbol	rating	Unit
Input voltage	Vin, EN	6.3	V
Operating Ambient temperature	Top	-40 to +85	°C
Storage temperature	TSTO	-40 to +85	°C

**6-2 Electrical characteristics (Ta=25°C)**

Parameter	Symbol	Condition	Min.	Typ.	Max.	Unit	
Input voltage	$V_{in}$		2.0	-	5.5	V	
UVLO voltage	UVLO		1.65	1.8	1.95	V	
Input leak current	lin-off	$V_{in}=3.7V$ , $EN=0V$	-	0.1	2	$\mu A$	
Operating quiescent current (*3)	lin-on	$V_{in}=3.7V$ , $EN=ON$ $I_{out}=0A$	LXDC2MB10G-454	0.5	-	-	$\mu A$
			LXDC2MB11G-423				
			LXDC2MB12G-424				
			LXDC2MB15G-456				
			LXDC2MB18G-425				
		$V_{in}=5.0V$ $EN=ON$ $I_{out}=0A$	LXDC2MB25G-426				
			LXDC2MB30G-427				
			LXDC2MB33G-428				
		Output voltage accuracy	Vout				
LXDC2MB11G-423	1.067			1.1	1.133		
LXDC2MB12G-424	1.164			1.2	1.236		
LXDC2MB15G-456	1.455			1.5	1.545		
LXDC2MB18G-425	1.746			1.8	1.854		
LXDC2MB25G-426	2.425			2.5	2.575		
LXDC2MB30G-427	2.91			3.0	3.09		
LXDC2MB33G-428	3.201			3.3	3.399		
Load current range	Iout		0		50	mA	
Ripple voltage	Vrpl	$V_{in}=3.7V$ , $I_{out}=30mA$ , $BW=100MHz$	LXDC2MB10G-454	-	15	-	mV
			LXDC2MB11G-423				
			LXDC2MB12G-424				
			LXDC2MB15G-456				
			LXDC2MB18G-425				
		$V_{in}=5.0V$ , $I_{out}=30mA$ , $BW=100MHz$	LXDC2MB25G-426				
			LXDC2MB30G-427				
			LXDC2MB33G-428				

Parameter	Symbol	Condition	Min.	Typ.	Max.	Unit	
Efficiency	EFF	Vin=3.7V, Iout=10mA	LXDC2MB10G-454		78		%
			LXDC2MB11G-423		79		
			LXDC2MB12G-424		80	-	
			LXDC2MB15G-456		84	-	
		Vin=5.0V, Iout=10mA	LXDC2MB18G-425		86	-	
			LXDC2MB25G-426		86	-	
			LXDC2MB30G-427		89		
			LXDC2MB33G-428		90	-	
EN control voltage	VENH	ON ; Enable	1.4		Vin	V	
	VENL	OFF ; Disable	0		0.25	V	

(\*1) External capacitors (Cin:10uF, Cout:22uF) shall be placed near the module in order to proper operation.

(\*2)The above characteristics are tested using the application circuit on section 8 (A).

(\*3) Operating quiescent current are tested using the application circuit on section 8 (B).

### 6-3 Thermal and Current De-rating Information

The following figures show the power dissipation and temperature rise characteristics. These data are measured on Murata's evaluation board of this device at no air-flow condition.

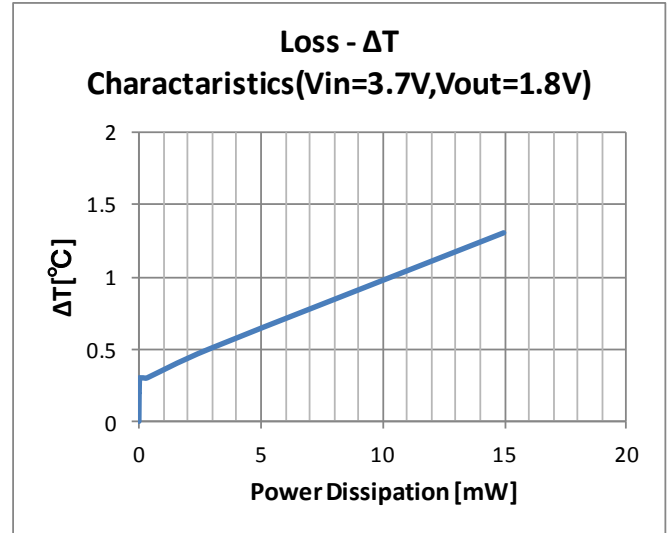
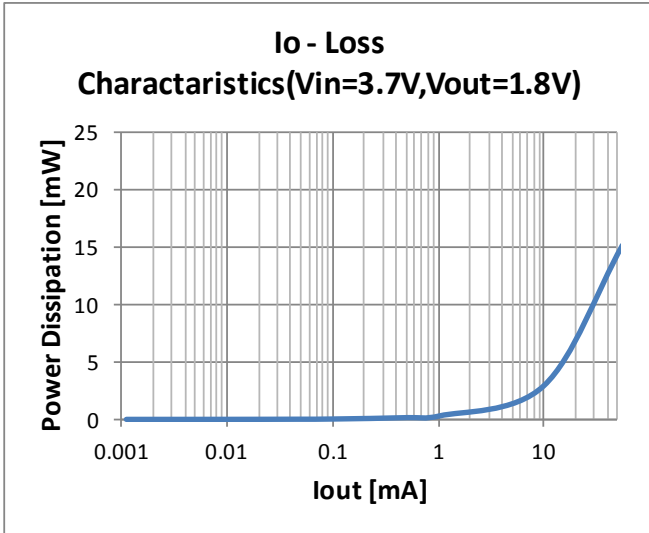

The output current of the device may need to be de-rated if it is operated in a high ambient temperature or in a continuous power delivering application. The amount of current de-rating is highly dependent on the environmental thermal conditions, i.e. PCB design, nearby components or effective air flows. Care should especially be taken in applications where the device temperature exceeds 85°C.

The IC temperature of the device must be kept lower than the maximum rating of 85 °C. It is generally recommended to take an appropriate de-rating to IC temperature for a reliable operation. A general de-rating for the temperature of semiconductor is 80%.

## 7. Detailed Description

### UVLO (Under Voltage Lock Out)

The input voltage ( $V_{in}$ ) must reach or exceed the UVLO voltage (1.8V<sub>typ</sub>) before the device begins the start up sequence even when EN pin kept high. UVLO function keeps away of an unstable operation at low  $V_{in}$  range

### Enable

The device starts operation when EN is set high and starts up. For proper operation, the EN pin must be terminated to logic high and must not be left floating. If the pin is left open, the device may operate at light load but will not work at heavy load.

Pulling the EN pin to logic low forces the device shutdown. The device does not have a discharge function when it turns off. If you prefer a discharge function, please contact Murata representative.

### 100% Duty Cycle Operation

The device can operate 100% duty cycle mode, in which high-side switch is constantly turned ON, thereby providing a low input-to-output voltage difference.

When  $V_{in}$  and  $V_{out}$  becomes close and the duty gets close to 100%, the switching pulse will skip the nominal switching period and the output voltage ripple may be larger than other condition. It should be noted that this condition does not mean a failure of the device.

## 8. Test Circuit

(A)

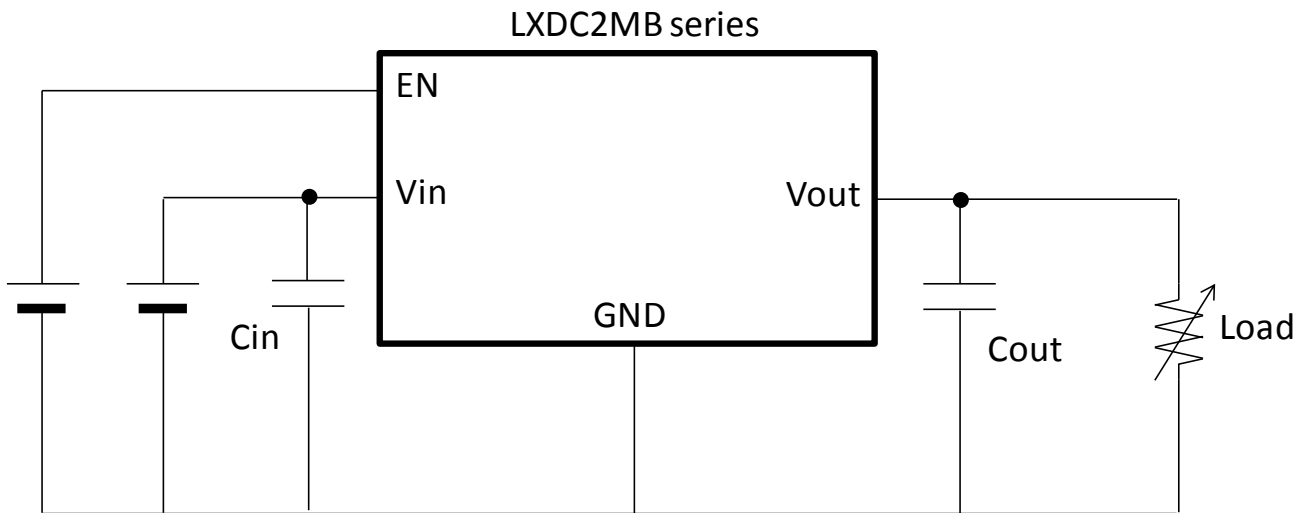

$C_{in}$  : 10 $\mu$ F/6.3V GRM155R60J106M  
 $C_{out}$  : 22 $\mu$ F/6.3V GRM155R60J226M / GRM188R60J226M

(B)

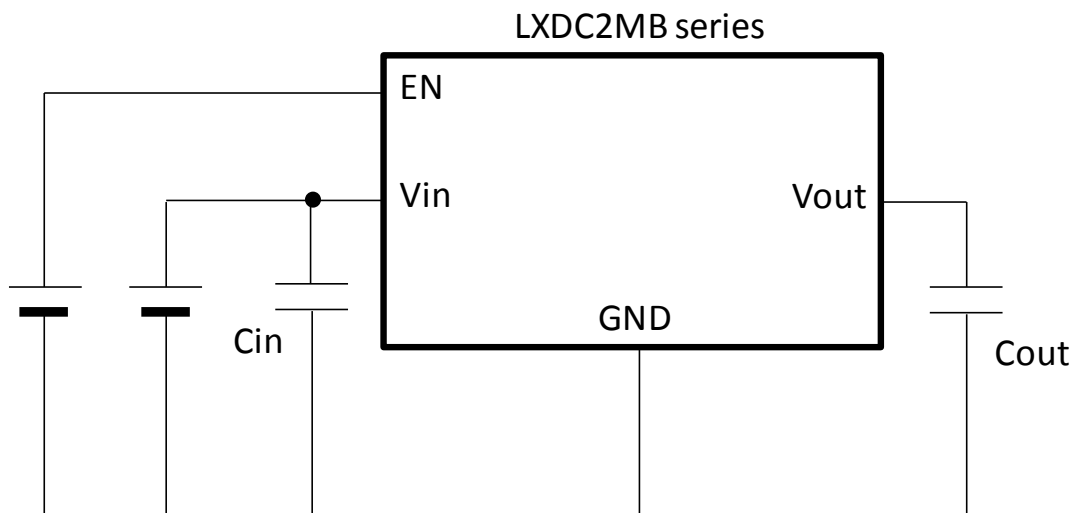

$C_{in}$  : 10 $\mu$ F/6.3V GRM155R60J106M  
 $C_{out}$  : 22 $\mu$ F/6.3V GRM155R60J226M / GRM188R60J226M



## 9. Measurement Data

### Micro DC-DC Converter evaluation board

#### Measurement setup

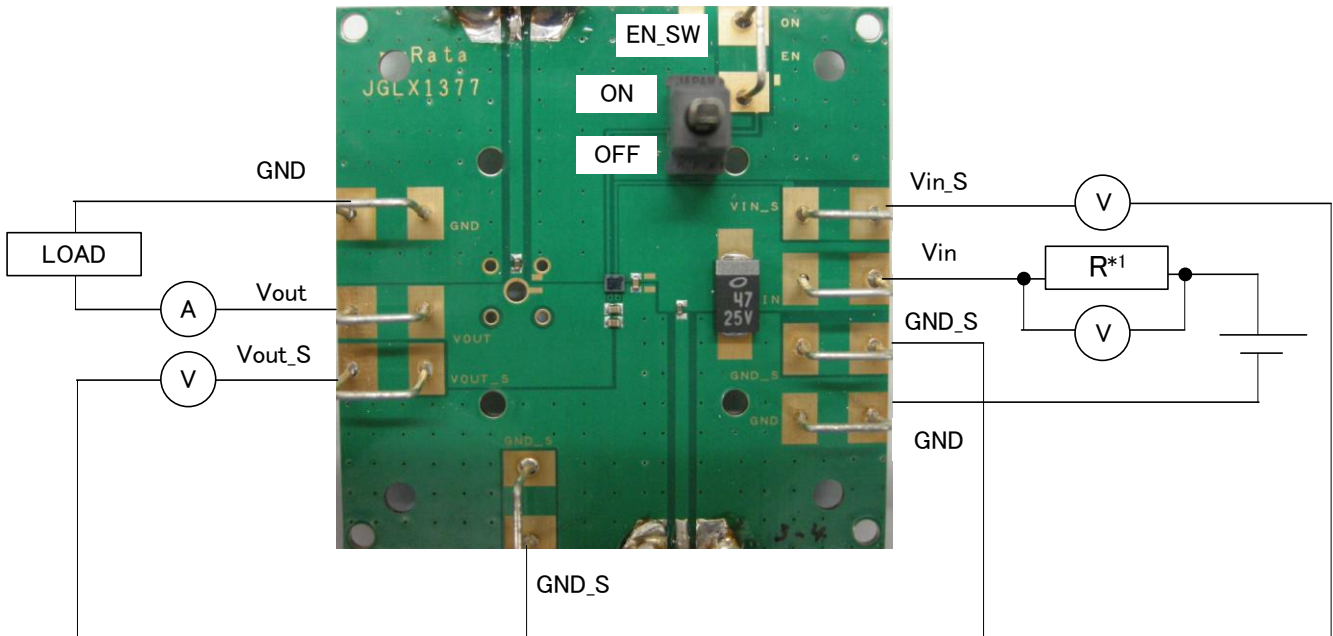

\*1 : Using Resistor (ex : 100  $\Omega$ ) is recommended to measure  $I_{in}$

The enable switch has three states (ON, OFF and Open).

1. When it is toggled to “ON” side, the device starts operation.
2. When it is toggled to “OFF” side, the device stop operation and keep shut down status.
3. When it is set to open, the EN pin floats and an external voltage can be applied to the EN terminal pin on the EVB. If you don't apply an external voltage to EN pin, the enable switch should not to be set to the middle position.

※The 47uF capacitor is for the evaluation kit only, and has been added to compensate for the long test cables.

## Typical Measurement Data (reference purpose only) (Ta=25°C)

### Efficiency

• Vin=5.0V, Vout=3.3V

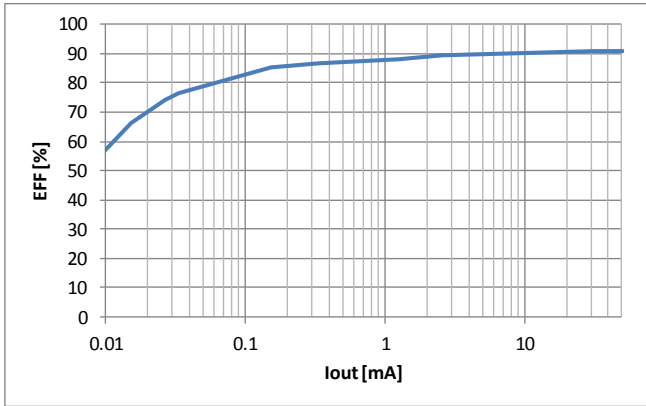

• Vin=5.0V, Vout=3.0V

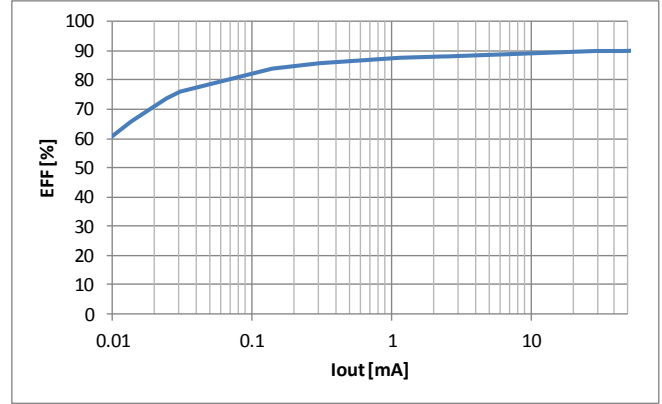

• Vin=3.7V, Vout=1.8V

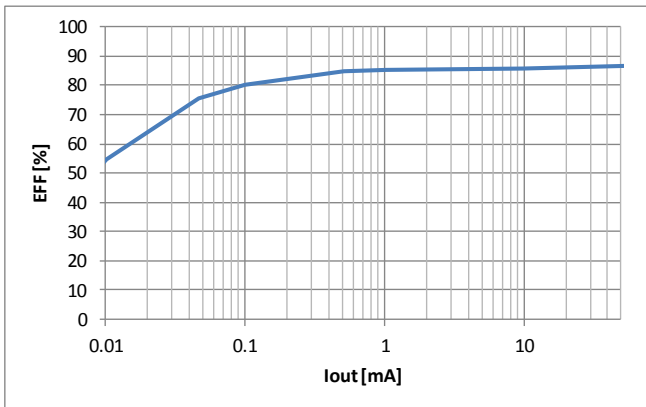

• Vin=3.7V, Vout=1.5V

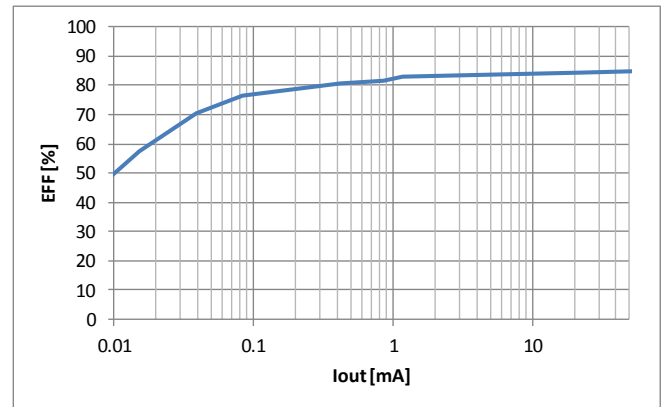

• Vin=3.7V, Vout=1.1V

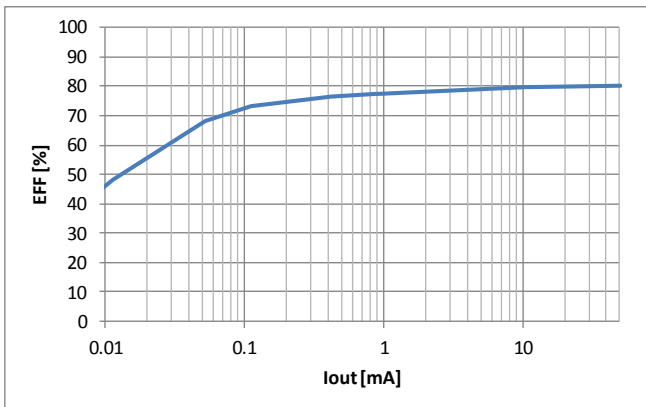

• Vin=3.7V, Vout=1.0V

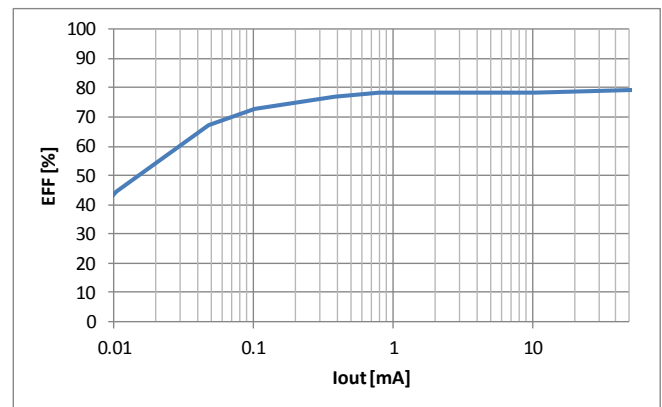

## Load Regulation

•  $V_{in}=5.0V$ ,  $V_{out}=3.3V$

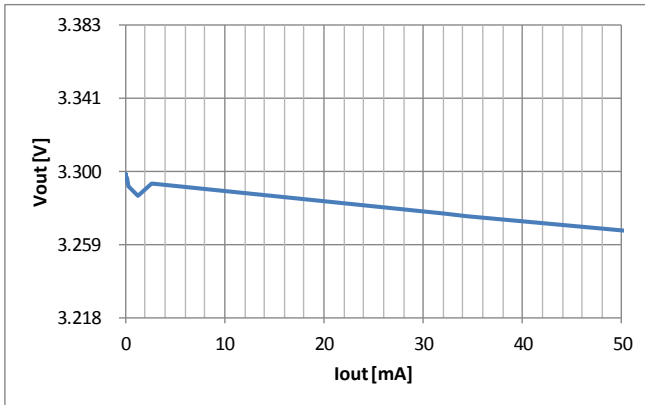

•  $V_{in}=5.0V$ ,  $V_{out}=3.0V$

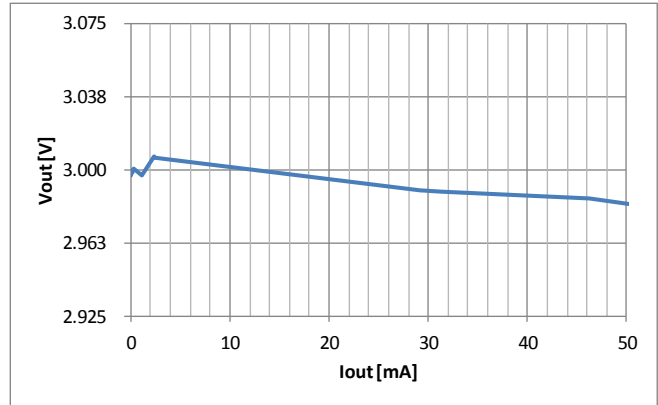

•  $V_{in}=3.7V$ ,  $V_{out}=1.8V$

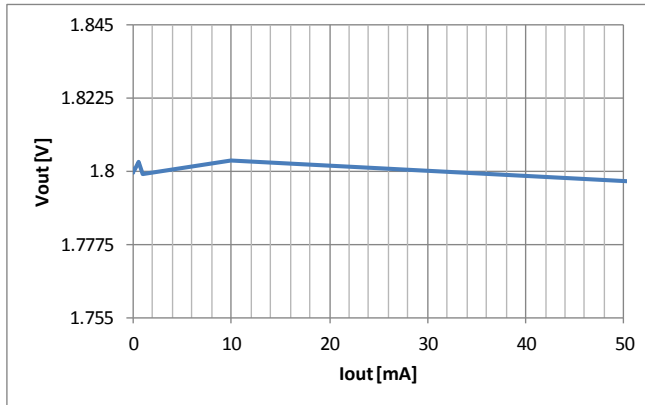

•  $V_{in}=3.7V$ ,  $V_{out}=1.5V$

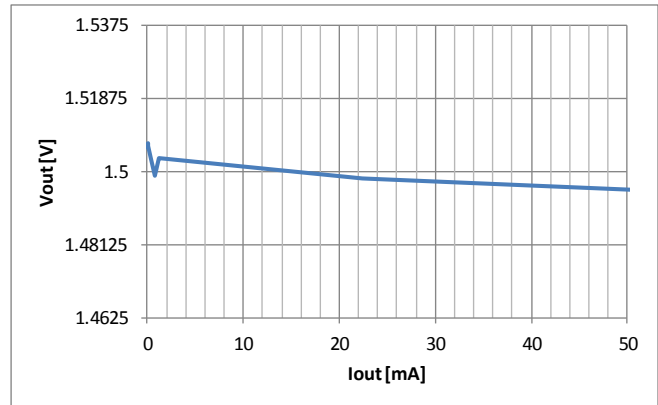

•  $V_{in}=3.7V$ ,  $V_{out}=1.1V$

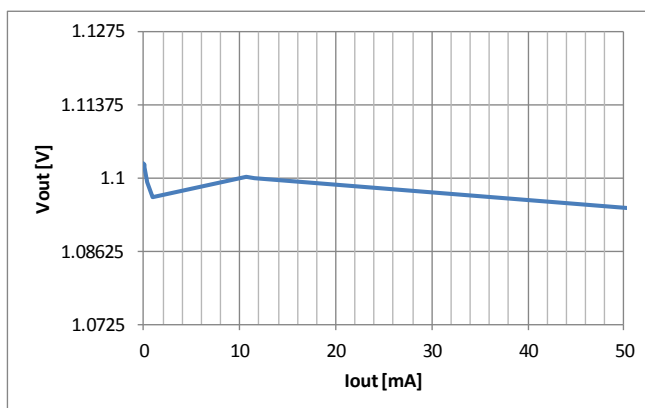

•  $V_{in}=3.7V$ ,  $V_{out}=1.0V$

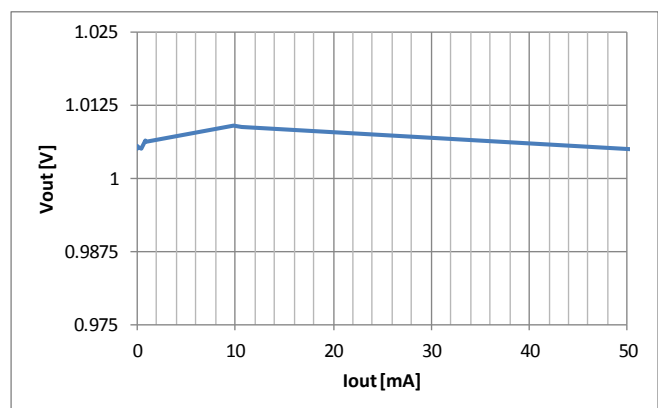

### Output Ripple-Noise

• Vin=5.0V, Vout=3.3V, BW : 100MHz

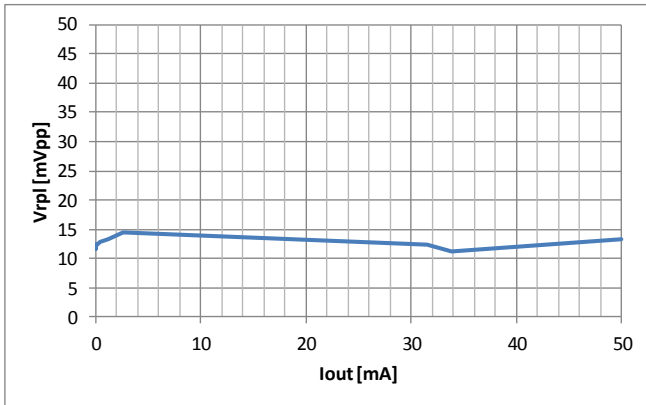

• Vin=5.0V, Vout=3.0V, BW : 100MHz

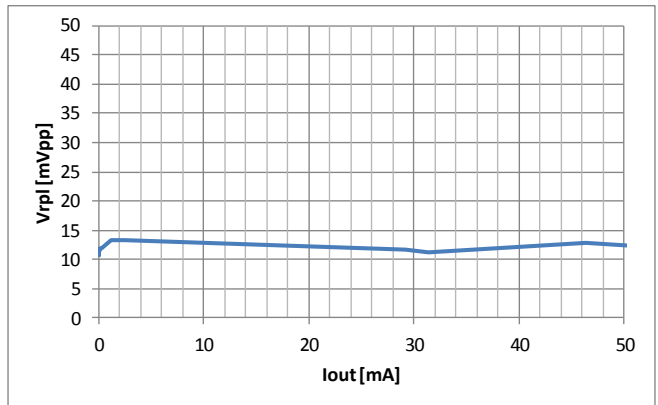

• Vin=3.7V, Vout=1.8V, BW : 100MHz

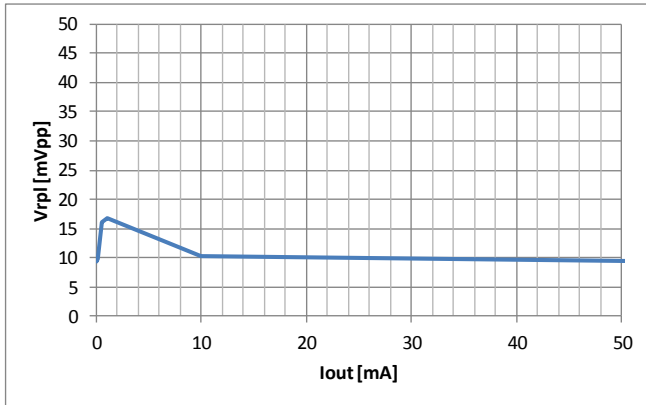

• Vin=3.7V, Vout=1.5V, BW : 100MHz

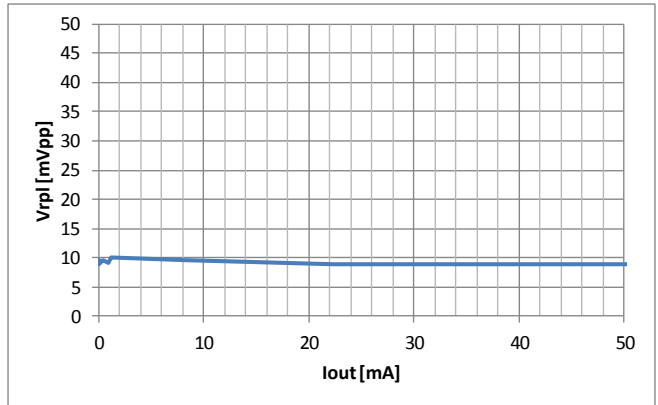

• Vin=3.7V, Vout=1.1V, BW : 100MHz

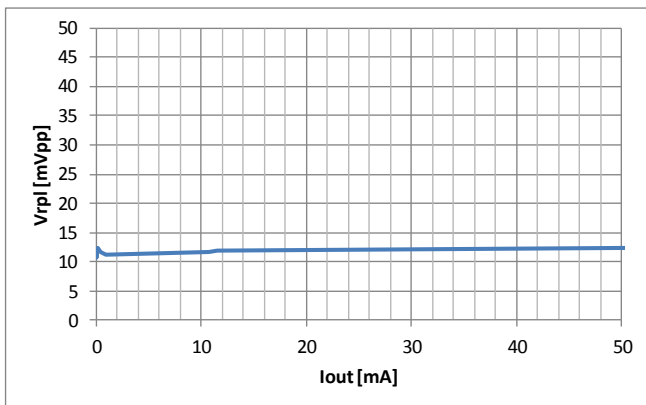

• Vin=3.7V, Vout=1.0V, BW : 100MHz

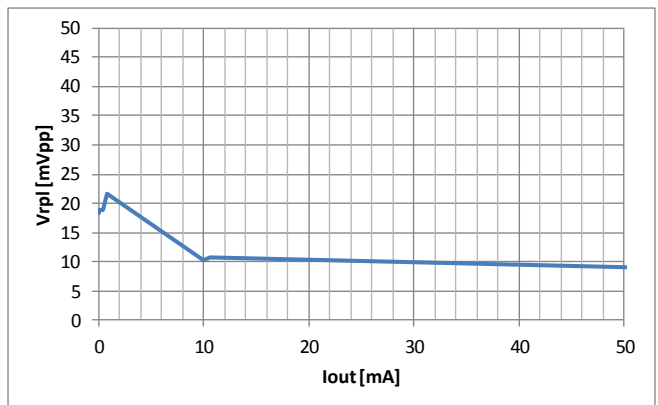

## Load Transient Response

• Vin=5.0V, Vout=3.3V

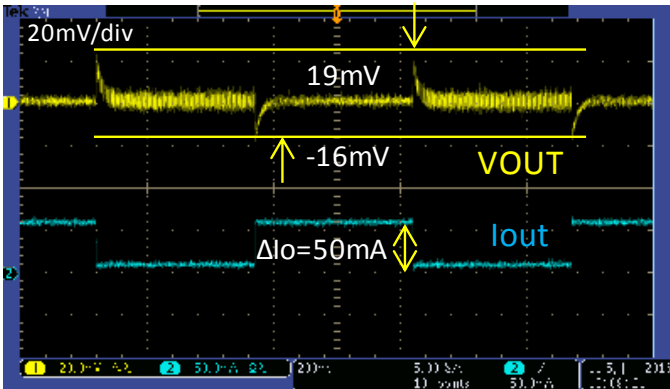

• Vin=5.0V, Vout=3.0V

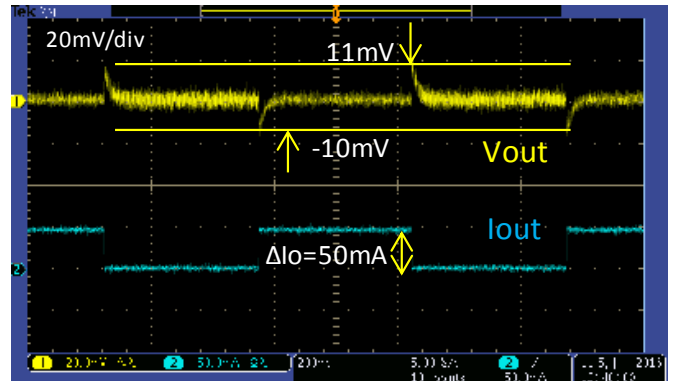

• Vin=3.7V, Vout=1.8V

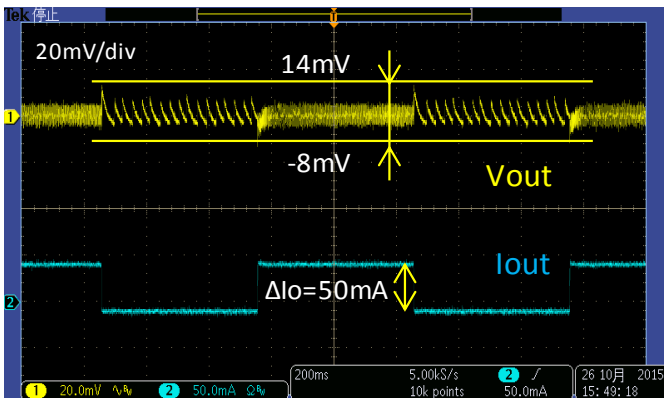

• Vin=3.7V, Vout=1.5V

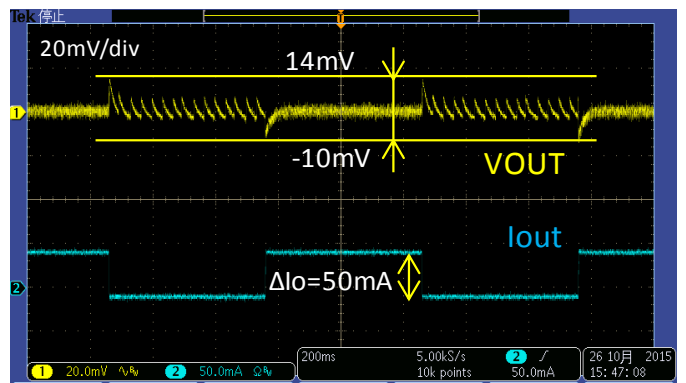

• Vin=3.7V, Vout=1.1V

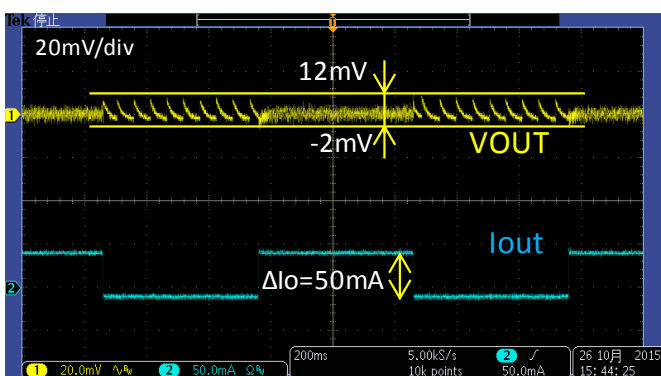

• Vin=3.7V, Vout=1.0V

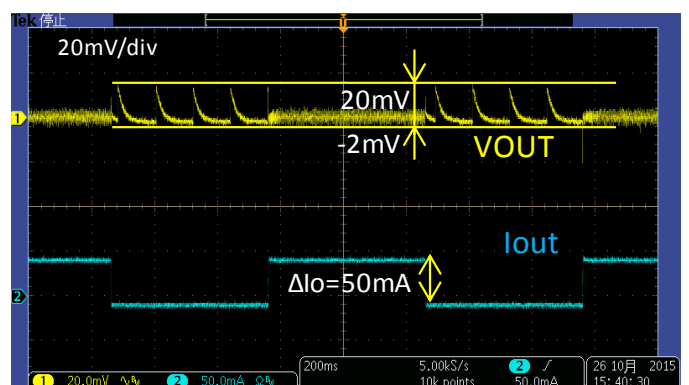

## 10. Reliability Tests

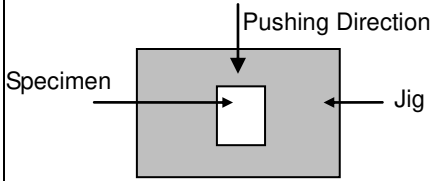
No.	Items		Specifications	Test Methods	QTY	Result (NG)
1	Vibration Resistance		Appearance : No severe damages	Solder specimens on the testing jig (glass fluorine boards) shown in appended Fig.1 by a Pb free solder. The soldering shall be done either by iron or reflow and be conducted with care so that the soldering is uniform and free of defect such as by heat shock.  Frequency : 10~2000 Hz Acceleration : 196 m/s <sup>2</sup> Direction : X,Y,Z 3 axis Period : 2 h on each direction Total 6 h.	18	G (0)
2	Deflection			Solder specimens on the testing jig (glass epoxy boards) shown in appended Fig.2 by a Pb free solder. The soldering shall be done either by iron or reflow and be conducted with care so that the soldering is uniform and free of defect such as by heat shock. Deflection : 1.6mm		
3	Soldering strength (Push Strength)		9.8 N Minimum	Solder specimens onto test jig shown below. Apply pushing force at 0.5mm/s until electrode pads are peeled off or ceramics are broken. Pushing force is applied to longitudinal direction.  	18	G (0)
4	Solderability of Termination		75% of the terminations is to be soldered evenly and continuously.	Immerse specimens first an ethanol solution of rosin, then in a Pb free solder solution for 3±0.5 sec. at 245±5 °C. Preheat : 150 °C, 60 sec. Solder Paste : Sn-3.0Ag-0.5Cu Flux : Solution of ethanol and rosin (25 % rosin in weight proportion)	18	G (0)
5	Resistance to Soldering Heat (Reflow)	Appearance  Electrical specifications	No severe damages  Satisfy specifications listed in paragraph 6-2.	Preheat Temperature : 150-180 °C Preheat Period : 90+/-30 sec. High Temperature : 220 °C High Temp. Period : 20sec. Peak Temperature : 260+5/-0 °C Specimens are soldered twice with the above condition, and then kept in room condition for 24 h before measurements.	18	G (0)

No.	Items	Specifications	Test Methods	QTY	Result (NG)									
6	High Temp. Exposure	Appearance Electrical specifications	Temperature : 85±2 °C Period : 1000+48/-0 h Room Condition : 2~24h	18	G (0)									
7	Temperature Cycle		Condition : 100 cycles in the following table	18	G (0)									
<table border="1"> <thead> <tr> <th>Step</th> <th>Temp(°C)</th> <th>Time(min)</th> </tr> </thead> <tbody> <tr> <td>1</td> <td>Min. Operating Temp.+0/-3</td> <td>30±3</td> </tr> <tr> <td>2</td> <td>Max. Operating Temp.+3/-0</td> <td>30±3</td> </tr> </tbody> </table>			Step			Temp(°C)	Time(min)	1	Min. Operating Temp.+0/-3	30±3	2	Max. Operating Temp.+3/-0	30±3	
Step	Temp(°C)		Time(min)											
1	Min. Operating Temp.+0/-3		30±3											
2	Max. Operating Temp.+3/-0		30±3											
8	Humidity (Steady State)	Satisfy specifications listed in paragraph 6-2.	Temperature : 85±2 °C Humidity : 80~90%RH Period : 1000+48/-0 h Room Condition : 2~24h	18	G (0)									
9	Low Temp. Exposure		Temperature : -40±2 °C Period : 1000+48/-0 h Room Condition : 2~24h	18	G (0)									
10	ESD(Machine Model)		C : 200pF, R : 0Ω TEST Voltage : +/-100V Number of electric discharges : 1	5	G (0)									
11	ESD(Human Body Model)		C : 100pF, R : 1500Ω TEST Voltage : +/-1000V Number of electric discharges : 1	5	G (0)									

Fig.1  
Land Pattern

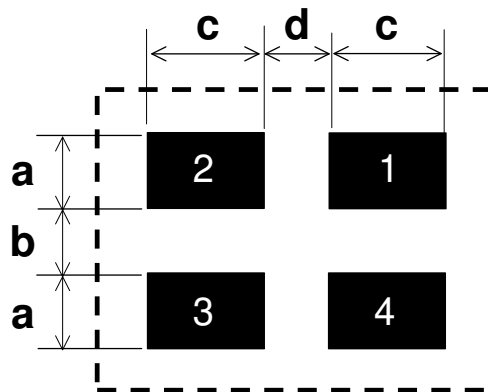

unit (mm)

Mark	Dimension	Mark	Dimension
a	0.38	d	0.32
b	0.33		
c	0.58		

\*Reference purpose only



Fig.2  
Testing board

Unit: mm

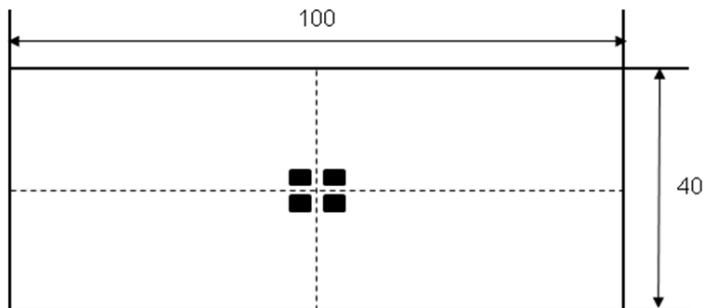

■: Land pattern is same as figure 1  
Glass-fluorine board  $t=1.6\text{mm}$   
Copper thickness over  $35\ \mu\text{m}$

Mounted situation

Unit: mm

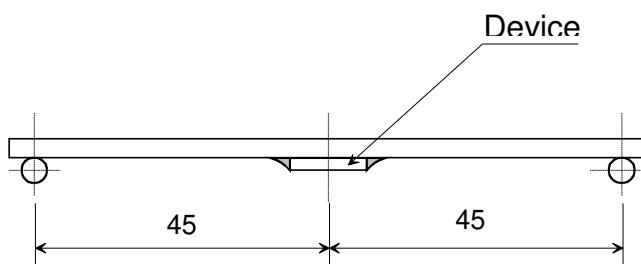

Test method

Unit: mm

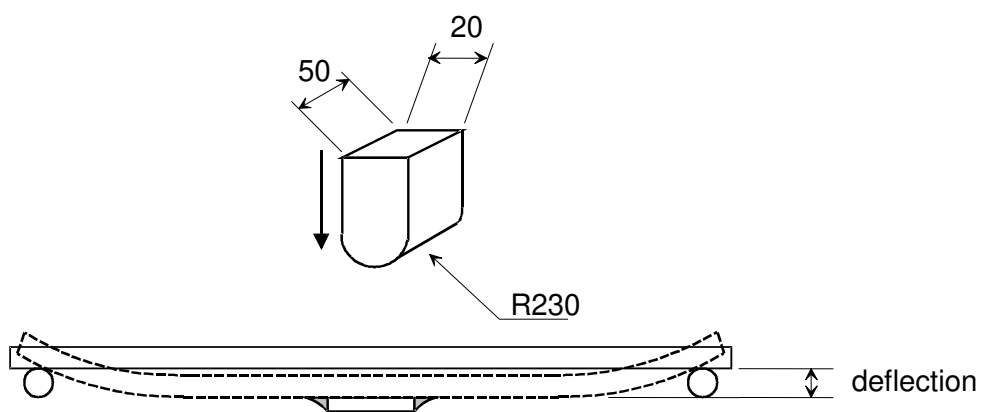

## 11. Tape and Reel Packing

### 1) Dimensions of Tape (Paper tape)

(Unit : mm)

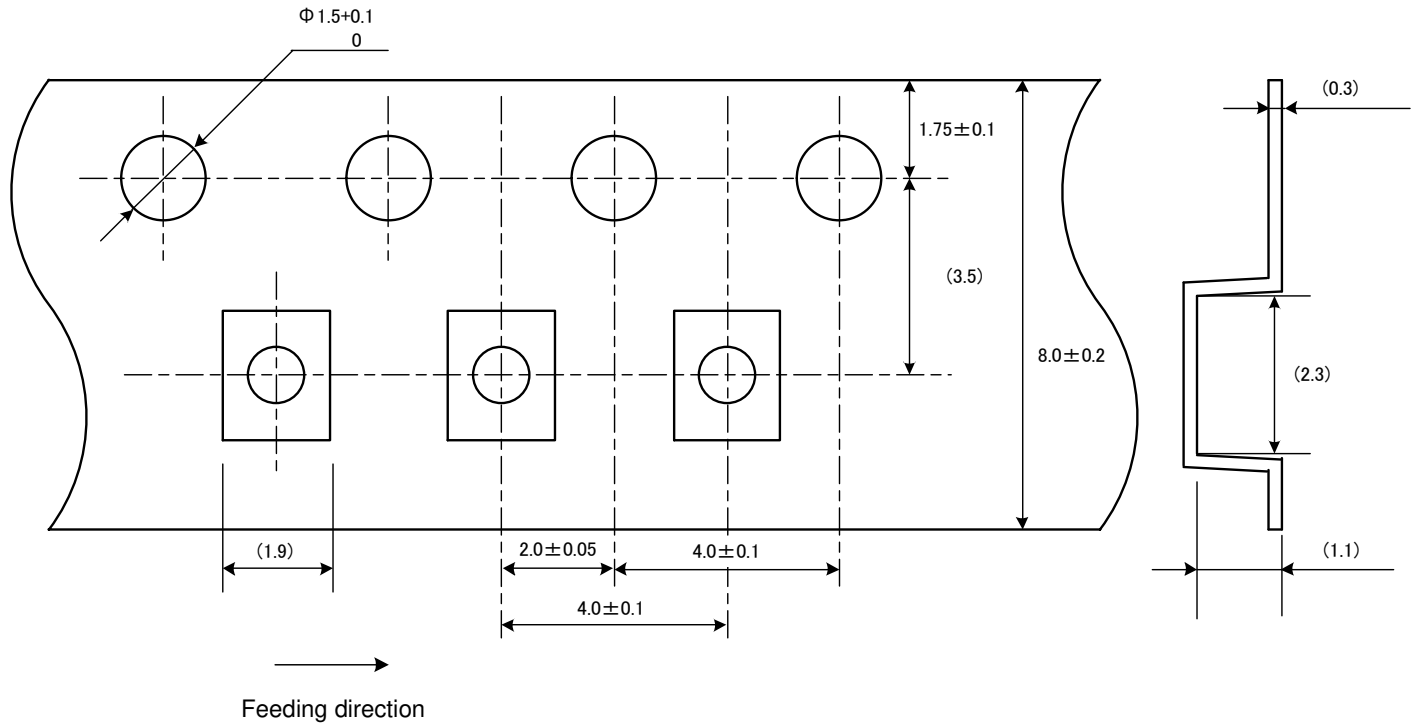

### 2) Dimensions of Reel

(Unit : mm)

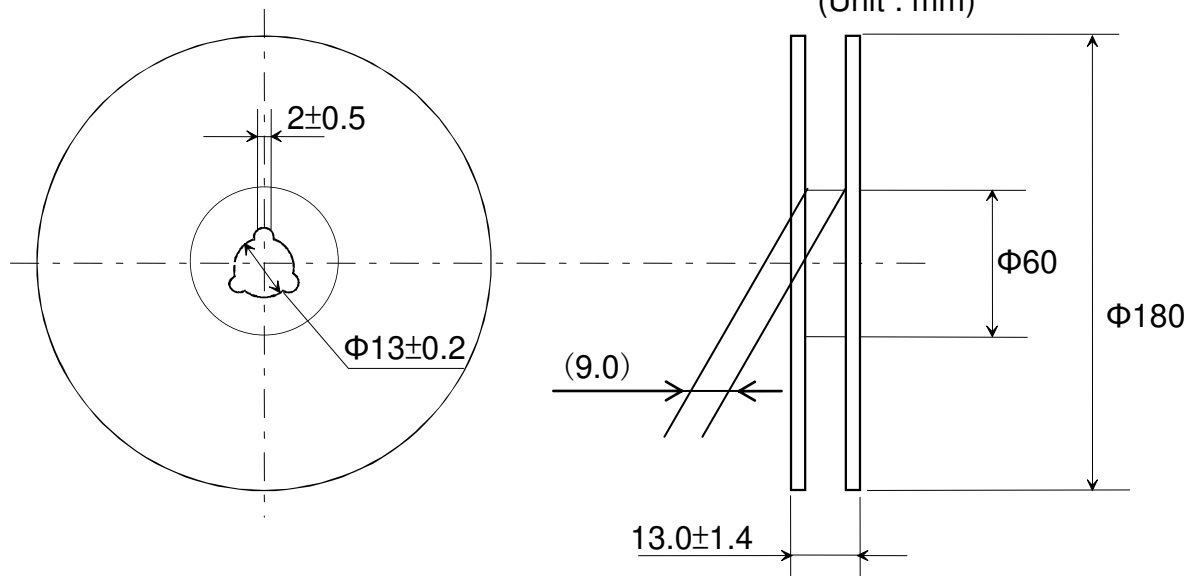

### 3) Taping Diagrams

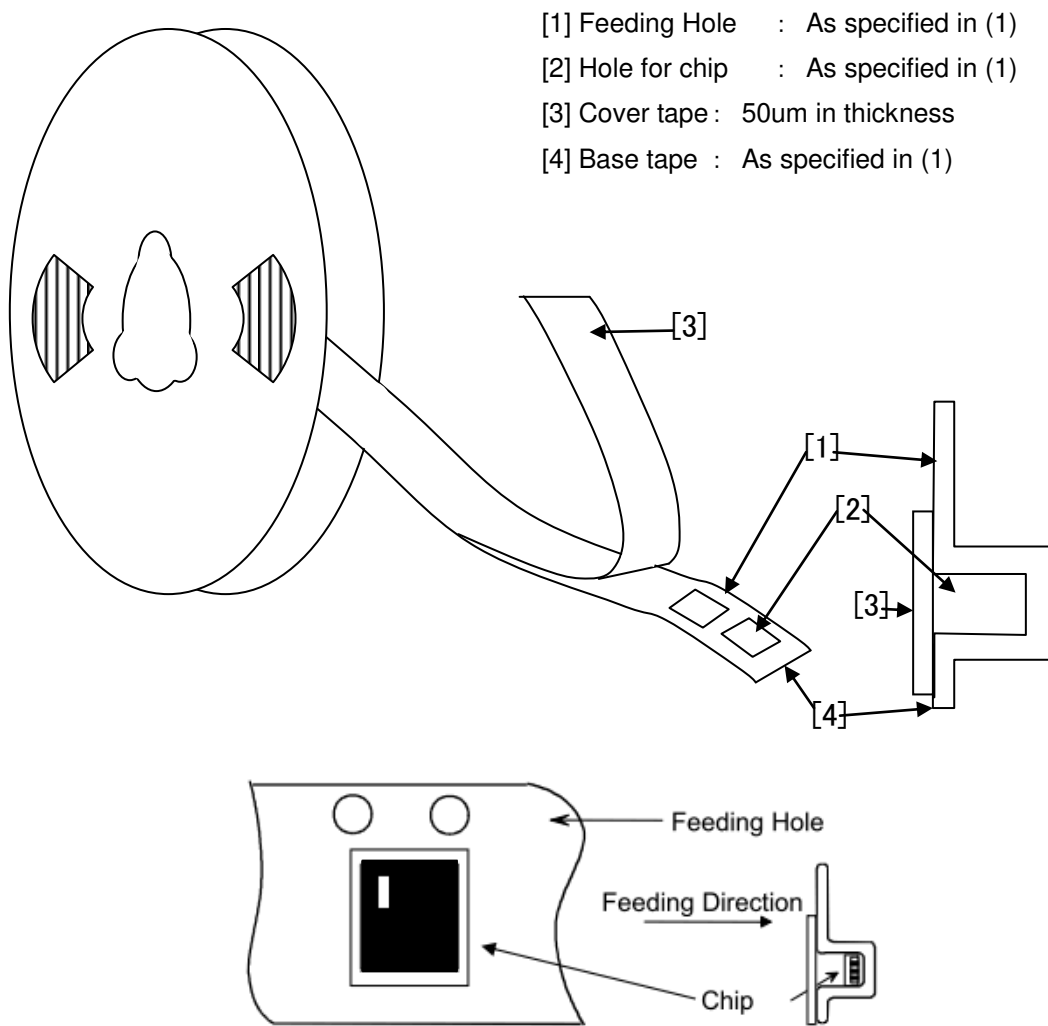

4) Leader and Tail tape

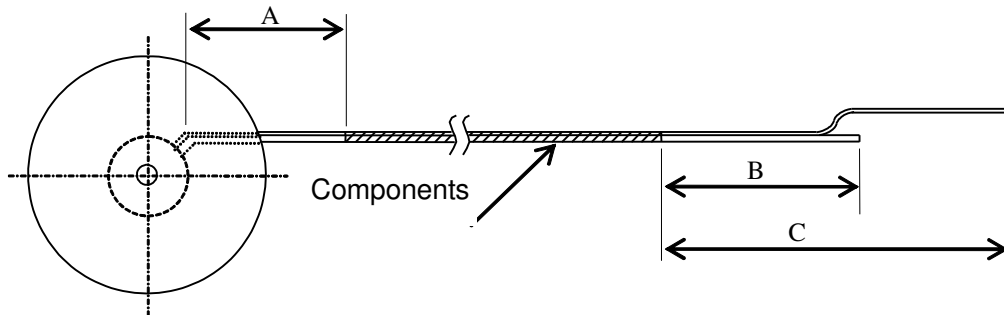

Symbol	Items	Ratings(mm)
A	No components at trailer	min 160
B	No components at leader	min 100
C	Whole leader	min 400

5) The tape for chips are wound clockwise, the feeding holes to the right side as the tape is pulled toward the user.

6) Packaging unit: 3000pcs./ reel

7) Material :     Base Tape     ... Plastic  
                  Reel             ... Plastic

Antistatic coating for both base tape and reel

8) Peeling of force

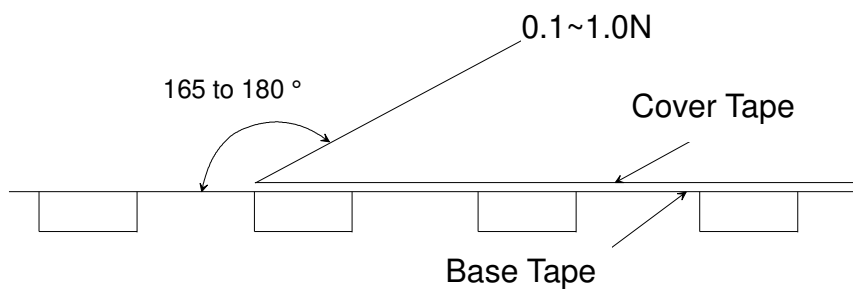

## NOTICE

### 1. Storage Conditions:

- The product shall be stored without opening the packing under the ambient temperature from 5 to 35 deg.C and humidity from 20 to 70%RH.  
(Packing materials, in particular, may be deformed at the temperature over 40 deg.C.)
- The product left more than 6 months after reception, it needs to be confirmed the solderability before used.
  - The product shall be stored in non corrosive gas (Cl<sub>2</sub>, NH<sub>3</sub>, SO<sub>2</sub>, No<sub>x</sub>, etc.).
  - Any excess mechanical shock including, but not limited to, sticking the packing materials by sharp object and dropping the product, shall not be applied in order not to damage the packing materials.
- After the packing opened, the product shall be stored at  $\leq 30$  deg.C /  $\leq 60$  %RH and the product shall be used within 168 hours.

When the color of the indicator in the packing changed, the product shall be baked before soldering.

This product is applicable to MSL3 (Based on IPC/JEDEC J-STD-020)

### 2. Handling Conditions:

Be careful in handling or transporting the product. Excessive stress or mechanical shock may damage the product because of the nature of ceramics structure.

Do not touch the product, especially the terminals, with bare hands. Doing so may result in poor solderability.

### 3. Standard PCB Design (Land Pattern and Dimensions):

All the ground terminals should be connected to ground patterns. Furthermore, the ground pattern should be provided between IN and OUT terminals. Please refer to the specifications for the standard land dimensions.

The recommended land pattern and dimensions are shown for a reference purpose only.

Electrical, mechanical and thermal characteristics of the product shall depend on the pattern design and material / thickness of the PCB. Therefore, be sure to check the product performance in the actual set.

When using underfill materials, be sure to check the mechanical characteristics in the actual set.

#### 4. Soldering Conditions:

Soldering is allowed up through 2 times.

Carefully perform preheating :  $\Delta T$  less than 130 °C.

When products are immersed in solvent after mounting, pay special attention to maintain the temperature difference within 100 °C. Soldering must be carried out by the above mentioned conditions to prevent products from damage. Contact Murata before use if concerning other soldering conditions.

##### Reflow soldering standard conditions (example)

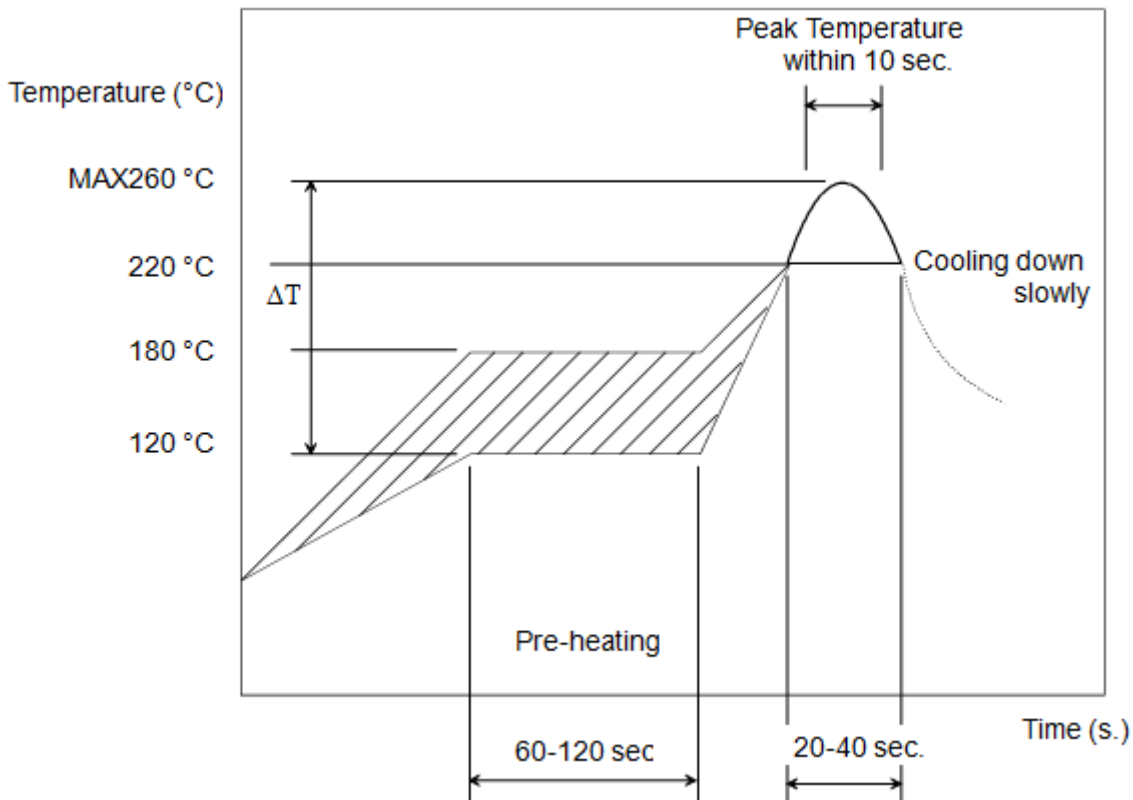

Use rosin type flux or weakly active flux with a chlorine content of 0.2 wt % or less.

## 5. Cleaning Conditions:

The product is not designed to be cleaned after soldering.

## 6. Operational Environment Conditions:

Products are designed to work for electronic products under normal environmental conditions (ambient temperature, humidity and pressure). Therefore, products have no problems to be used under the similar conditions to the above-mentioned. However, if products are used under the following circumstances, it may damage products and leakage of electricity and abnormal temperature may occur.

- In an atmosphere containing corrosive gas ( Cl<sub>2</sub>, NH<sub>3</sub>, SO<sub>x</sub>, NO<sub>x</sub> etc.).
- In an atmosphere containing combustible and volatile gases.
- In a dusty environment.
- Direct sunlight
- Water splashing place.
- Humid place where water condenses.
- In a freezing environment.

If there are possibilities for products to be used under the preceding clause, consult with Murata before actual use.

If static electricity is added to this product, degradation and destruction may be produced.

Please use it after consideration enough so that neither static electricity nor excess voltage is added at the time of an assembly and measurement.

If product malfunctions may result in serious damage, including that to human life, sufficient fail-safe measures must be taken, including the following:

- (1) Installation of protection circuits or other protective device to improve system safety
- (2) Installation of redundant circuits in the case of single-circuit failure.

## 7. Input Power Capacity:

Products shall be used in the input power capacity as specified in this specifications.

Inform Murata beforehand, in case that the components are used beyond such input power capacity range.

## 8. Limitation of Applications:

The products are designed and produced for application in ordinary electronic equipment (AV equipment, OA equipment, telecommunication, etc). If the products are to be used in devices requiring extremely high reliability following the application listed below, you should consult with the Murata staff in advance.

- Aircraft equipment.
- Aerospace equipment
- Undersea equipment.
- Power plant control equipment.
- Medical equipment.
- Transportation equipment (vehicles, trains, ships, etc.).
- Automobile equipment which includes the genuine brand of car manufacture, car factory-installed option and dealer-installed option.
- Traffic signal equipment.
- Disaster prevention / crime prevention equipment.
- Data-processing equipment.
- Application which malfunction or operational error may endanger human life and property of assets.
- Application which related to occurrence the serious damage
- Application of similar complexity and/ or reliability requirements to the applications listed in the above.



### Note:

Please make sure that your product has been evaluated and confirmed against your specifications when our product is mounted to your product.

Product specifications are subject to change or our products in it may be discontinued without advance notice.

This catalog is for reference only and not an official product specification document, therefore, please review and approve our official product specification before ordering this product.