

# Distinctive Characteristics

Highly visible legends and choice of screwdriver, shaft, or dial adjusted actuators provide trouble-free code setting. Knob actuator also available.

Detent mechanism gives crisp, positive action for accurate switch setting.

Sealed construction prevents contamination and allows automated soldering and washing.

Optional panel seal mount available in the DRA model which can be installed with behind-panel o-ring for protection against splashed or sprayed liquids.

Real or complement code setting identified by color-keyed actuator.

Crimped terminals ensure secure PC mounting and prevent dislodging during soldering.

Self-wiping contacts assure contact reliability and continuity.

Compact dimensions and low profile allow high density mounting and close stacking of PC boards.

Ultrasonically welded case, o-ring sealed actuator, and insert molded terminals seal out flux and other contaminants.

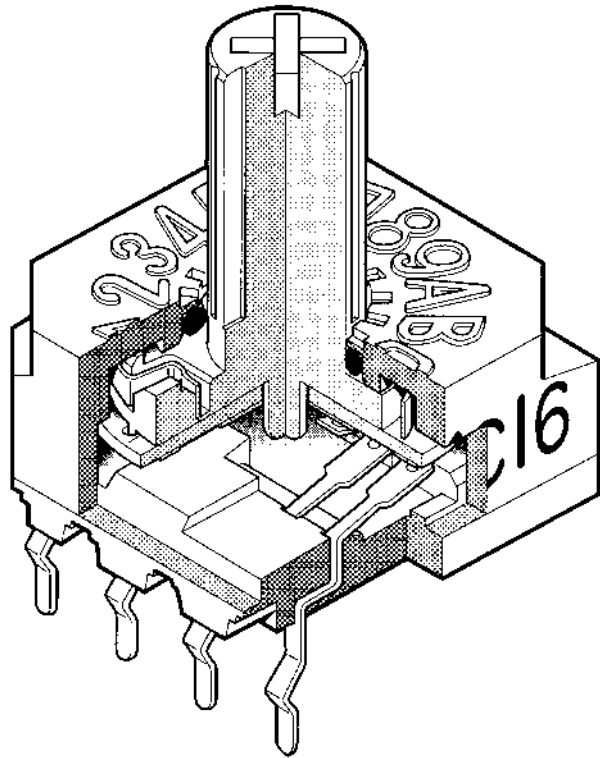

Actual Size

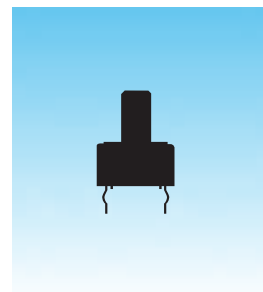

# General Specifications

## Electrical Capacity (Resistive Load)

<b>Switching Rating:</b>	100mA @ 5V DC
<b>Nonswitching Rating:</b>	100mA @ 50V DC

## Other Ratings

<b>Contact Resistance:</b>	80 milliohms maximum for all 4 contacts closed 30 milliohms maximum for 1 contact closed
<b>Insulation Resistance:</b>	1,000 megohms minimum @ 250V DC
<b>Dielectric Strength:</b>	250V AC minimum for 1 minute minimum
<b>Mechanical Life:</b>	20,000 detent operations minimum
<b>Electrical Life:</b>	20,000 detent operations minimum
Note: A detent operation is one actuator position operation or stepping. 20,000 detent operations = 1,250 cycles for hexadecimal devices or 2,000 cycles for decimal devices. A cycle is one 360° rotation.	
<b>Nominal Operating Torque:</b>	80 ~ 320 grams-cm (1.1 ~ 4.4 ounce•in)
<b>Contact Timing:</b>	Shorting (Avoid possible false signal by turning off power before switching.)

## Materials & Finishes

<b>Shaft &amp; Bushing (DRA only):</b>	Brass with nickel plating
<b>Actuator:</b>	Glass fiber reinforced polyester (PBT) (UL 94V-0)
<b>Housing &amp; Case:</b>	Glass fiber reinforced polyester (PBT) (UL 94V-0)
<b>O-rings:</b>	Nitrile butadiene rubber
<b>Base:</b>	Glass fiber reinforced polyester (PBT) (UL 94V-0)
<b>Movable Contact:</b>	Copper with gold plating
<b>Stationary Contacts:</b>	Phosphor bronze with gold plating
<b>Terminals:</b>	Phosphor bronze with gold plating

## Environmental Data

<b>Operating Temp Range:</b>	-25°C through +75°C (-13°F through +167°F)
<b>Humidity:</b>	90 ~ 95% for 96 hours @ 40°C (104°F)
<b>Vibration:</b>	10 ~ 55Hz with peak-to-peak amplitude of 1.5mm traversing the frequency range & returning in 1 minute; 3 right angled directions for 2 hours
<b>Shock:</b>	50G (490m/s <sup>2</sup> ) acceleration (tested in 3 right angled directions, with 3 shocks in each direction)

## Installation

<b>Mounting Torque for DRA:</b>	1.47Nm (13.0 lb•in) for double nut; .686Nm (6.08 lb•in) for single nut
<b>Knob Installation Force:</b>	39.2N maximum (8.82 lbf) for DRA model; 29.4N maximum (6.61 lbf) for DRF/DRF2 models
<b>Soldering Time &amp; Temperature:</b>	3 seconds @ 350°C manual soldering or 5 seconds @ 270°C solder pot
<b>Process Seal:</b>	See Supplement Index (page Z2) for specific processing data.

## Standards & Certifications

<b>Flammability Standards:</b>	UL 94V-0 rated actuator, housing, case, & base
<b>UL Recognition or CSA Certification:</b>	The DR series rotaries have not been tested for UL recognition or CSA certification. These switches are designed for use in a low-voltage, low-current, logic-level circuit. When used as intended in a logic-level circuit, the results do not produce hazardous energy.

## TYPICAL SWITCH ORDERING EXAMPLE

**DR**

**F**

ACTUATORS	
PCB Mount	
<b>F</b>	Screwdriver Actuated with White Dot Indicator
<b>F2</b>	Screwdriver Actuated with Arrow Indicator
<b>K</b>	Shaft Actuated
<b>S</b>	Dial Actuated (for straight terminals only)
Panel or PCB Mount	
<b>A</b>	Knob Actuated

**R**

POSITIONS	
<b>10</b>	Decimal
<b>16</b>	Hexadecimal

**10**

**P**

PC TERMINALS	
<b>P</b>	Straight
<b>H</b>	Right Angle

**BRACKETS**

<b>No Code</b>	No Bracket (supplied w/standard hardware)
<b>B</b>	With Bracket (order hardware separately)

For DRA model only

**DESCRIPTION FOR TYPICAL ORDERING EXAMPLE**

**DRFR10P**

CIRCUITS	
<b>R</b>	Real Coded (Orange Actuator)
<b>C</b>	Complement Coded (White on F2 actuator & Red on all other actuators)

## ACTUATORS

**F** Screwdriver Actuated with White Dot Indicator

Adjusted with a flat or Phillips tipped screwdriver or Snap-in Knob AT4061.

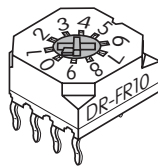

**AT4061**  
Optional Snap-in Knob for "F" Actuator

Polyamide

Black knob with clear flange

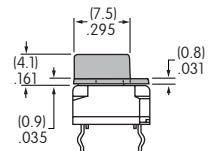
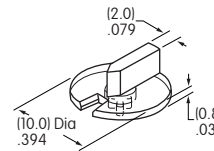

Install knob before mounting on PCB for right angle type; it should not be removed once mounted. When mounting, align slit in knob with white pointer on actuator.

**F2** Screwdriver Actuated with Arrow Indicator

Adjusted with a flat tipped screwdriver.

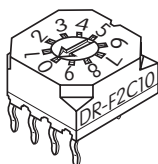

**K** Shaft Actuated

Adjusted by hand or with a flat or Phillips tipped screwdriver.

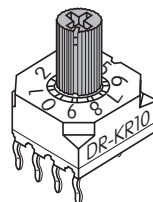

**S** Dial Actuated

Adjusted by hand or with a flat tipped screwdriver.



Actuators are fully rotational and operate either clockwise or counterclockwise.

Actuator Colors: Orange for real coded devices. Red for complement coded devices, except arrow actuated (F2) which is white.

## ACTUATORS (CONTINUED)

### A Knob Actuated

Knobs AT433, AT4103, and AT4104 (shown below) are available and can be ordered separately.

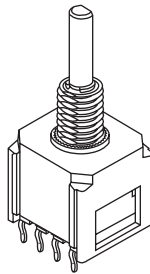

### Panel Mounting With Locking Ring

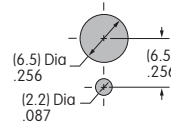

Maximum Effective Panel Thickness: 1.5mm (.059")

### Panel Mounting With D-flat

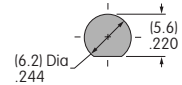

Maximum Effective Panel Thickness: 2.3mm (.091")

Actuators are fully rotational and operate either clockwise or counterclockwise.

### AT513M (2 supplied) Metric Hexagon Nut



### AT515M (1 supplied) Locking Ring



### AT509 (1 supplied) Lockwasher

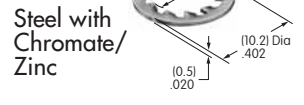

### AT085 (Optional) O-ring



Nitrile Butadiene Rubber

Hardware can be ordered separately for bracketed models.

### AT433 Plain Black

Polyacetal  
Black only

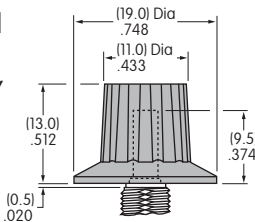

### AT4103 Small Color Tipped

Polyester Base: Black  
Polyamide Tip Colors: A, B, C, E, F, G, H

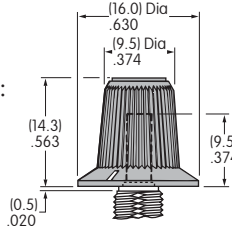

### AT4104 Large Color Tipped

Polyester Base: Black  
Polyamide Tip Colors: A, B, C, E, F, G, H

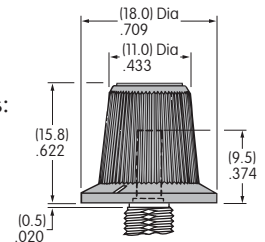

All actuator knobs must be ordered separately.

Color Codes: **A** Black **B** White **C** Red **E** Yellow **F** Green **G** Blue **H** Gray

## TRUTH TABLES (CIRCUITS & POSITIONS)

Actuator Position ● = on		10 Decimal										16 Hexadecimal															
		0	1	2	3	4	5	6	7	8	9	0	1	2	3	4	5	6	7	8	9	A	B	C	D	E	F
<b>R</b> Real Coded Model Numbers: DRFR, DRKR, DRSR, DRAR	1		●		●		●		●		●		●		●		●		●		●		●		●		●
	2			●	●			●	●				●	●			●	●				●	●			●	●
	4					●	●	●	●					●	●	●	●					●	●	●	●		
	8								●	●									●	●	●	●	●	●	●	●	●
<b>C</b> Complement Coded Model Numbers: DRFC, DRKC, DRSC, DRAC	1	●		●		●		●		●		●		●		●		●		●		●		●		●	
	2	●	●			●	●			●	●			●	●			●	●			●	●			●	●
	4	●	●	●	●				●	●				●	●			●	●			●	●			●	●
	8	●	●	●	●	●	●	●						●	●	●	●					●	●	●	●		

Terminal numbers are actually on switch.

### TYPICAL SWITCH DIMENSIONS

#### P Straight PC Terminals

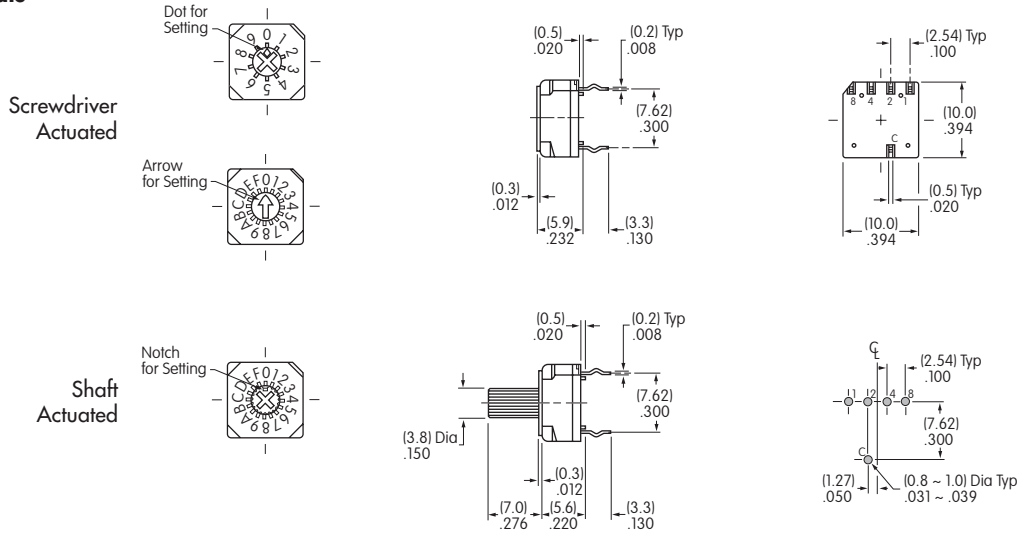

DRFR10P

#### H Right Angle PC Terminals

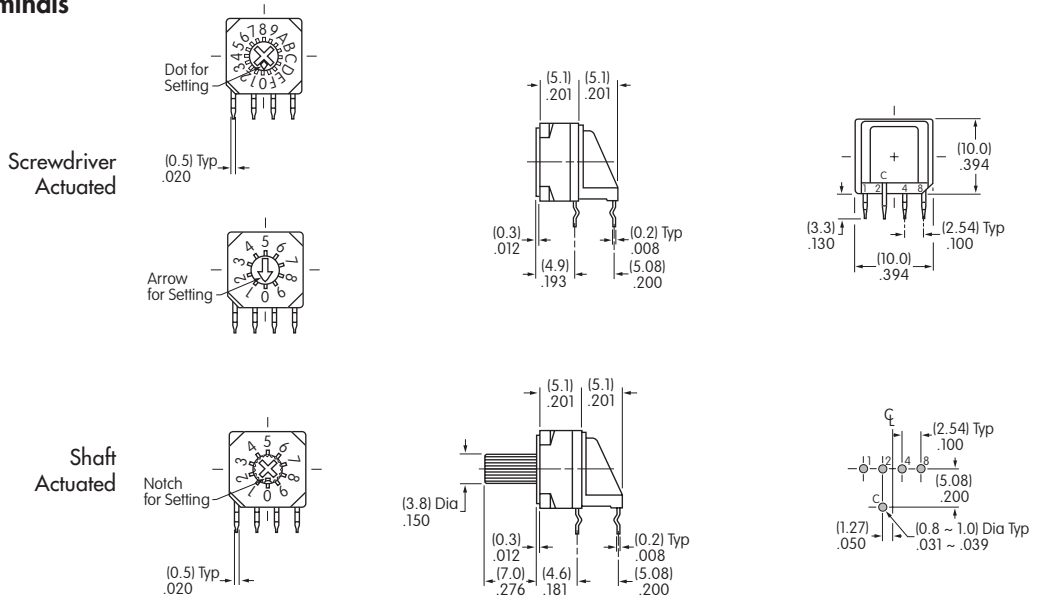

DRKR10H

#### P Straight PC Terminals

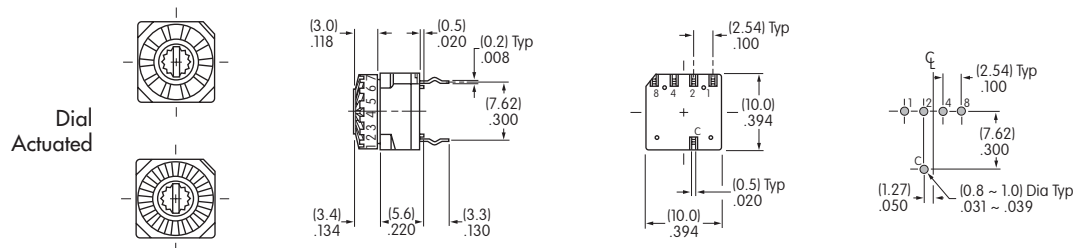

DRSR10P

## TYPICAL SWITCH DIMENSIONS

### Straight PC Terminals • Panel Mount

P

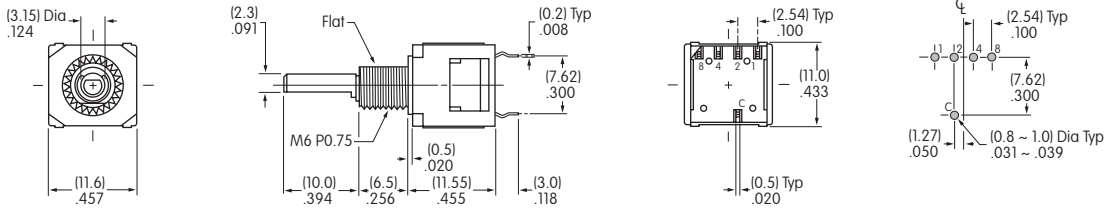

Shown in Position 0 with shaft flat rotated 180° from bushing flat.

DRAR10P

(Hardware is not supplied with bracketed models.)

### Straight PC Terminals • With Bracket

PB

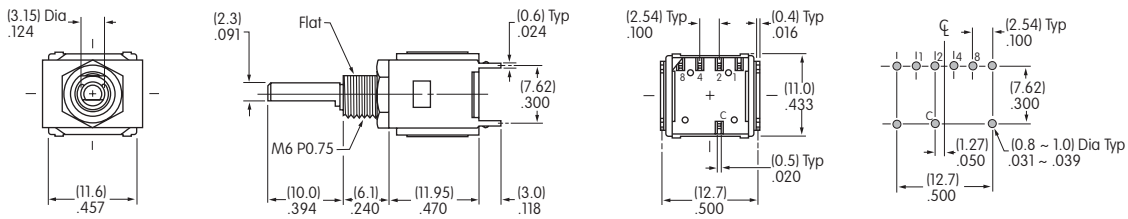

Shown in Position 0 with shaft flat rotated 180° from bushing flat.

DRAR10PB

### Right Angle PC Terminals • Panel Mount

H

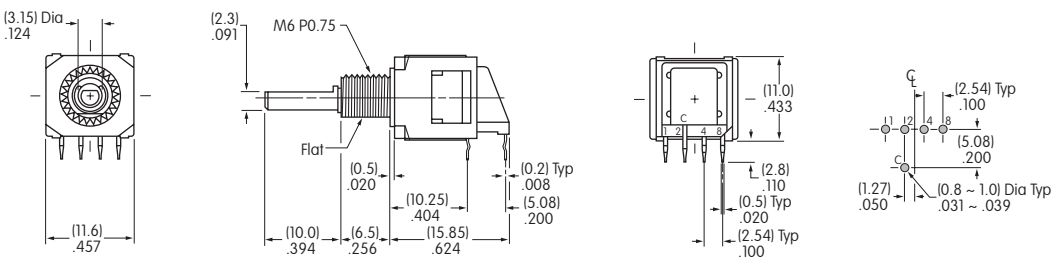

Shown in Position 0 with shaft flat rotated 180° from bushing flat.

DRAR10H

(Hardware is not supplied with bracketed models.)

### Right Angle PC Terminals • With Bracket

HB

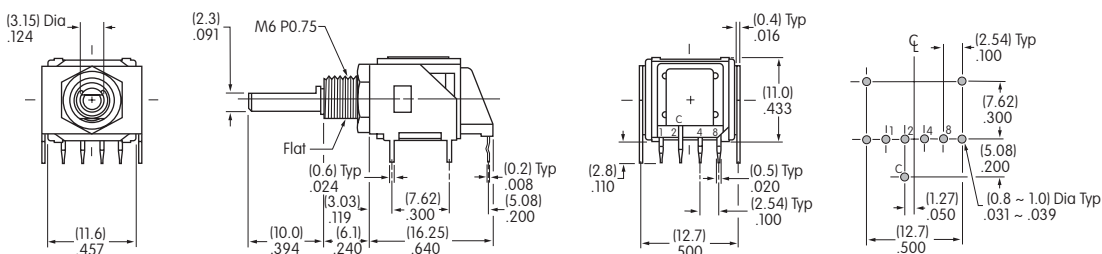

Shown in Position 0 with shaft flat rotated 180° from bushing flat.

DRAR10HB