

ADC088S102 8-Channel, 500 kSPS to 1 MSPS, 8-Bit A/D Converter

Check for Samples: [ADC088S102](#)

FEATURES

- Eight Input Channels
- Variable Power Management
- Independent Analog and Digital Supplies
- SPI/QSPI/MICROWIRE/DSP Compatible
- Packaged in 16-Lead TSSOP

APPLICATIONS

- Automotive Navigation
- Portable Systems
- Medical Instruments
- Mobile Communications
- Instrumentation and Control Systems

KEY SPECIFICATIONS

- Conversion Rate: 500 kSPS to 1 MSPS
- DNL ($V_A = V_D = 5.0\text{ V}$): $\pm 0.3\text{ LSB (max)}$
- INL ($V_A = V_D = 5.0\text{ V}$): $\pm 0.2\text{ LSB (max)}$
- Power Consumption
 - 3V Supply: 1.8 mW (typ)
 - 5V Supply: 8.0 mW (typ)

Connection Diagram

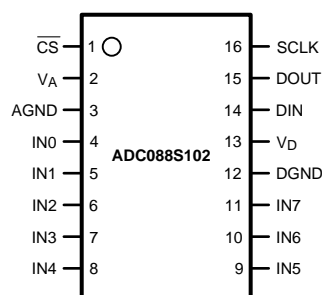

Figure 1. 16-Lead TSSOP
See Package Number PW0016A

DESCRIPTION

The ADC088S102 is a low-power, eight-channel CMOS 8-bit analog-to-digital converter specified for conversion throughput rates of 500 kSPS to 1 MSPS. The converter is based on a successive-approximation register architecture with an internal track-and-hold circuit. It can be configured to accept up to eight input signals at inputs IN0 through IN7.

The output serial data is straight binary and is compatible with several standards, such as SPI, QSPI, MICROWIRE, and many common DSP serial interfaces.

The ADC088S102 may be operated with independent analog and digital supplies. The analog supply (V_A) can range from +2.7V to +5.25V, and the digital supply (V_D) can range from +2.7V to V_A . Normal power consumption using a +3V or +5V supply is 1.8 mW and 8.0 mW, respectively. The power-down feature reduces the power consumption to 0.03 μW using a +3V supply and 0.15 μW using a +5V supply.

The ADC088S102 is packaged in a 16-lead TSSOP package. Operation is specified over the extended industrial temperature range of -40°C to $+105^\circ\text{C}$.



Please be aware that an important notice concerning availability, standard warranty, and use in critical applications of Texas Instruments semiconductor products and disclaimers thereto appears at the end of this data sheet.

All trademarks are the property of their respective owners.

Block Diagram

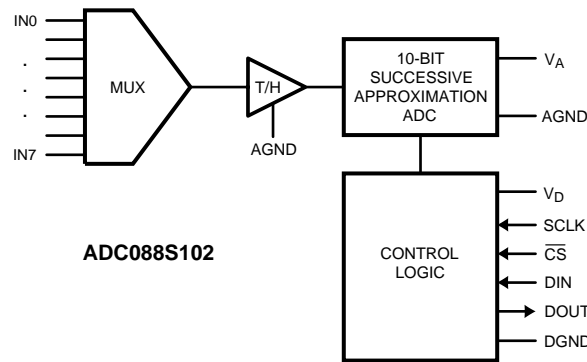

Pin Descriptions and Equivalent Circuits

| Pin No. | Symbol | Equivalent Circuit | Description |
|---------------------|-----------------|--------------------|---|
| ANALOG I/O | | | |
| 4 - 11 | IN0 to IN7 | | Analog inputs. These signals can range from 0V to V_{REF} . |
| DIGITAL I/O | | | |
| 16 | SCLK | | Digital clock input. The specified performance range of frequencies for this input is 8 MHz to 16 MHz. This clock directly controls the conversion and readout processes. |
| 15 | DOUT | | Digital data output. The output samples are clocked out of this pin on the falling edges of the SCLK pin. |
| 14 | DIN | | Digital data input. The ADC088S102's Control Register is loaded through this pin on rising edges of the SCLK pin. |
| 1 | \overline{CS} | | Chip select. On the falling edge of \overline{CS} , a conversion process begins. Conversions continue as long as \overline{CS} is held low. |
| POWER SUPPLY | | | |
| 2 | V_A | | Positive analog supply pin. This voltage is also used as the reference voltage. This pin should be connected to a quiet +2.7V to +5.25V source and bypassed to GND with 1 μ F and 0.1 μ F monolithic ceramic capacitors located within 1 cm of the power pin. |
| 13 | V_D | | Positive digital supply pin. This pin should be connected to a +2.7V to V_A supply, and bypassed to GND with a 0.1 μ F monolithic ceramic capacitor located within 1 cm of the power pin. |
| 3 | AGND | | The ground return for the analog supply and signals. |
| 12 | DGND | | The ground return for the digital supply and signals. |



These devices have limited built-in ESD protection. The leads should be shorted together or the device placed in conductive foam during storage or handling to prevent electrostatic damage to the MOS gates.

Absolute Maximum Ratings⁽¹⁾⁽²⁾

| | | |
|--|------------------|----------------------------------|
| Analog Supply Voltage V_A | | -0.3V to 6.5V |
| Digital Supply Voltage V_D | | -0.3V to $V_A + 0.3V$, max 6.5V |
| Voltage on Any Pin to GND | | -0.3V to $V_A + 0.3V$ |
| Input Current at Any Pin ⁽³⁾ | | ±10 mA |
| Package Input Current ⁽³⁾ | | ±20 mA |
| Power Dissipation at $T_A = 25^\circ\text{C}$ | | See ⁽⁴⁾ |
| ESD Susceptibility | Human Body Model | 2500V |
| | Machine Model | 250V |
| For soldering specifications: see product folder at http://www.ti.com/lit/SNOA549C | | |
| Junction Temperature | | +150°C |
| Storage Temperature | | -65°C to +150°C |

- (1) Absolute Maximum Ratings indicate limits beyond which damage to the device may occur. Operating Ratings indicate conditions for which the device is functional, but do not ensure specific performance limits. For ensured specifications and test conditions, see the Electrical Characteristics. The ensured specifications apply only for the test conditions listed. Some performance characteristics may degrade when the device is not operated under the listed test conditions.
- (2) If Military/Aerospace specified devices are required, please contact the Texas Instruments Sales Office/ Distributors for availability and specifications.
- (3) When the input voltage at any pin exceeds the power supplies (that is, $V_{IN} < \text{AGND}$ or $V_{IN} > V_A$ or V_D), the current at that pin should be limited to 10 mA. The 20 mA maximum package input current rating limits the number of pins that can safely exceed the power supplies with an input current of 10 mA to two.
- (4) The absolute maximum junction temperature (T_{Jmax}) for this device is 150°C. The maximum allowable power dissipation is dictated by T_{Jmax} , the junction-to-ambient thermal resistance (θ_{JA}), and the ambient temperature (T_A), and can be calculated using the formula $P_{DMAX} = (T_{Jmax} - T_A)/\theta_{JA}$. In the 16-pin TSSOP, θ_{JA} is 96°C/W, so $P_{DMAX} = 1,200$ mW at 25°C and 625 mW at the maximum operating ambient temperature of 105°C. Note that the power consumption of this device under normal operation is a maximum of 12 mW. The values for maximum power dissipation listed above will be reached only when the ADC088S102 is operated in a severe fault condition (e.g. when input or output pins are driven beyond the power supply voltages, or the power supply polarity is reversed). Obviously, such conditions should always be avoided.

Operating Ratings⁽¹⁾⁽²⁾

| | |
|-----------------------|--|
| Operating Temperature | $-40^\circ\text{C} \leq T_A \leq +105^\circ\text{C}$ |
| V_A Supply Voltage | +2.7V to +5.25V |
| V_D Supply Voltage | +2.7V to V_A |
| Digital Input Voltage | 0V to V_A |
| Analog Input Voltage | 0V to V_A |
| Clock Frequency | 8 MHz to 16 MHz |

- (1) Absolute Maximum Ratings indicate limits beyond which damage to the device may occur. Operating Ratings indicate conditions for which the device is functional, but do not ensure specific performance limits. For ensured specifications and test conditions, see the Electrical Characteristics. The ensured specifications apply only for the test conditions listed. Some performance characteristics may degrade when the device is not operated under the listed test conditions.
- (2) All voltages are measured with respect to GND = 0V, unless otherwise specified.

Package Thermal Resistance

| Package | θ_{JA} |
|-------------------------------------|---------------|
| 16-lead TSSOP on 4-layer, 2 oz. PCB | 96°C / W |

ADC088S102 Converter Electrical Characteristics⁽¹⁾

The following specifications apply for $V_A = V_D = +2.7V$ to $+5.25V$, $AGND = DGND = 0V$, $f_{SCLK} = 8$ MHz to 16 MHz, $f_{SAMPLE} = 500$ kSPS to 1 MSPS, and $C_L = 50pF$, unless otherwise noted. **Boldface limits apply for $T_A = T_{MIN}$ to T_{MAX}** ; all other limits $T_A = 25^\circ C$.

| Parameter | Test Conditions | Typ | Limits ⁽²⁾ | Units | |
|--|--|-------------------------------------|-----------------------------|-------------------------------|---------------|
| STATIC CONVERTER CHARACTERISTICS | | | | | |
| | Resolution with No Missing Codes | | 8 | Bits | |
| INL | Integral Non-Linearity (End Point Method) | ± 0.05 | ± 0.2 | LSB (max) | |
| DNL | Differential Non-Linearity | ± 0.06 | ± 0.3 | LSB (max) | |
| V_{OFF} | Offset Error | +0.6 | ± 0.7 | LSB (max) | |
| OEM | Offset Error Match | ± 0.02 | ± 0.2 | LSB (max) | |
| FSE | Full Scale Error | +0.5 | ± 0.6 | LSB (max) | |
| FSEM | Full Scale Error Match | ± 0.02 | ± 0.2 | LSB (max) | |
| DYNAMIC CONVERTER CHARACTERISTICS | | | | | |
| FPBW | Full Power Bandwidth (-3dB) | | 8 | MHz | |
| SINAD | Signal-to-Noise Plus Distortion Ratio | $f_{IN} = 40.2$ kHz, -0.02 dBFS | 49.6 | 49.2 | dB (min) |
| SNR | Signal-to-Noise Ratio | $f_{IN} = 40.2$ kHz, -0.02 dBFS | 49.6 | 49.3 | dB (min) |
| THD | Total Harmonic Distortion | $f_{IN} = 40.2$ kHz, -0.02 dBFS | -71.2 | -63.7 | dB (max) |
| SFDR | Spurious-Free Dynamic Range | $f_{IN} = 40.2$ kHz, -0.02 dBFS | 67.9 | 63.9 | dB (min) |
| ENOB | Effective Number of Bits | $f_{IN} = 40.2$ kHz | 7.95 | 7.88 | Bits (min) |
| ISO | Channel-to-Channel Isolation | $f_{IN} = 20$ kHz | 69.6 | | dB |
| IMD | Intermodulation Distortion, Second Order Terms | $f_a = 19.5$ kHz, $f_b = 20.5$ kHz | -75.5 | | dB |
| | Intermodulation Distortion, Third Order Terms | $f_a = 19.5$ kHz, $f_b = 20.5$ kHz | -71.8 | | dB |
| ANALOG INPUT CHARACTERISTICS | | | | | |
| V_{IN} | Input Range | | 0 to V_A | V | |
| I_{DCL} | DC Leakage Current | | | ± 1 | μA (max) |
| C_{INA} | Input Capacitance | Track Mode | 33 | | pF |
| | | Hold Mode | 3 | | pF |
| DIGITAL INPUT CHARACTERISTICS | | | | | |
| V_{IH} | Input High Voltage | $V_A = V_D = +2.7V$ to $+3.6V$ | | 2.1 | V (min) |
| | | $V_A = V_D = +4.75V$ to $+5.25V$ | | 2.4 | V (min) |
| V_{IL} | Input Low Voltage | $V_A = V_D = +2.7V$ to $+5.25V$ | | 0.8 | V (max) |
| I_{IN} | Input Current | $V_{IN} = 0V$ or V_D | ± 0.01 | ± 1 | μA (max) |
| C_{IND} | Digital Input Capacitance | | 2 | 4 | pF (max) |
| DIGITAL OUTPUT CHARACTERISTICS | | | | | |
| V_{OH} | Output High Voltage | $I_{SOURCE} = 200 \mu A$ | | $V_D - 0.5$ | V (min) |
| V_{OL} | Output Low Voltage | $I_{SINK} = 200 \mu A$ to 1.0 mA, | | 0.4 | V (max) |
| I_{OZH}, I_{OZL} | Hi-Impedance Output Leakage Current | | | ± 1 | μA (max) |
| C_{OUT} | Hi-Impedance Output Capacitance ⁽¹⁾ | | 2 | 4 | pF (max) |
| | Output Coding | | Straight (Natural) Binary | | |

(1) Data sheet min/max specification limits are ensured by design, test, or statistical analysis.

(2) Tested limits are ensured to TI's AOQL (Average Outgoing Quality Level).

ADC088S102 Converter Electrical Characteristics⁽¹⁾ (continued)

The following specifications apply for $V_A = V_D = +2.7V$ to $+5.25V$, $AGND = DGND = 0V$, $f_{SCLK} = 8$ MHz to 16 MHz, $f_{SAMPLE} = 500$ kSPS to 1 MSPS, and $C_L = 50pF$, unless otherwise noted. **Boldface limits apply for $T_A = T_{MIN}$ to T_{MAX}** ; all other limits $T_A = 25^\circ C$.

| Parameter | | Test Conditions | Typ | Limits (2) | Units |
|--|---|--|------|---------------|-------------|
| POWER SUPPLY CHARACTERISTICS ($C_L = 10$ pF) | | | | | |
| V_A, V_D | Analog and Digital Supply Voltages | $V_A \geq V_D$ | | 2.7 | V (min) |
| | | | | 5.25 | V (max) |
| $I_A + I_D$ | Total Supply Current Normal Mode (\overline{CS} low) | $V_A = V_D = +2.7V$ to $+3.6V$, $f_{SAMPLE} = 1$ MSPS, $f_{IN} = 40$ kHz | 0.6 | 1.2 | mA (max) |
| | | $V_A = V_D = +4.75V$ to $+5.25V$, $f_{SAMPLE} = 1$ MSPS, $f_{IN} = 40$ kHz | 1.6 | 2.2 | mA (max) |
| | Total Supply Current Shutdown Mode (\overline{CS} high) | $V_A = V_D = +2.7V$ to $+3.6V$, $f_{SCLK} = 0$ kSPS | 10 | | nA |
| | | $V_A = V_D = +4.75V$ to $+5.25V$, $f_{SCLK} = 0$ kSPS | 30 | | nA |
| P_C | Power Consumption Normal Mode (\overline{CS} low) | $V_A = V_D = +3.0V$ $f_{SAMPLE} = 1$ MSPS, $f_{IN} = 40$ kHz | 1.8 | 3.6 | mW (max) |
| | | $V_A = V_D = +5.0V$ $f_{SAMPLE} = 1$ MSPS, $f_{IN} = 40$ kHz | 8.0 | 11.0 | mW (max) |
| | Power Consumption Shutdown Mode (\overline{CS} high) | $V_A = V_D = +3.0V$ $f_{SCLK} = 0$ kSPS | 0.03 | | μW |
| | | $V_A = V_D = +5.0V$ $f_{SCLK} = 0$ kSPS | 0.15 | | μW |
| AC ELECTRICAL CHARACTERISTICS | | | | | |
| $f_{SCLKMIN}$ | Minimum Clock Frequency | | 0.8 | 8 | MHz (min) |
| f_{SCLK} | Maximum Clock Frequency | | | 16 | MHz (max) |
| f_s | Sample Rate Continuous Mode | | 50 | 500 | kSPS (min) |
| | | | | 1 | MSPS (max) |
| $t_{CONVERT}$ | Conversion (Hold) Time | | | 13 | SCLK cycles |
| DC | SCLK Duty Cycle | | 30 | 40 | % (min) |
| | | | 70 | 60 | % (max) |
| t_{ACQ} | Acquisition (Track) Time | | | 3 | SCLK cycles |
| | Throughput Time | Acquisition Time + Conversion Time | | 16 | SCLK cycles |
| t_{AD} | Aperture Delay | | 4 | | ns |

ADC088S102 Timing Specifications

The following specifications apply for $V_A = V_D = +2.7V$ to $+5.25V$, $AGND = DGND = 0V$, $f_{SCLK} = 8\text{ MHz}$ to 16 MHz , $f_{SAMPLE} = 500\text{ kSPS}$ to 1 MSPS , and $C_L = 50pF$. **Boldface limits apply for $T_A = T_{MIN}$ to T_{MAX}** ; all other limits $T_A = 25^\circ C$.

| Parameter | | Test Conditions | Typ | Limits (1) | Units |
|------------|--|-----------------|-----|---|----------|
| t_{CSH} | \overline{CS} Hold Time after SCLK Rising Edge | | 0 | 10 | ns (min) |
| t_{CSS} | \overline{CS} Setup Time prior to SCLK Rising Edge | | 5 | 10 | ns (min) |
| t_{EN} | \overline{CS} Falling Edge to DOUT enabled | | 5 | 30 | ns (max) |
| t_{DACC} | DOUT Access Time after SCLK Falling Edge | | 17 | 27 | ns (max) |
| t_{DHLD} | DOUT Hold Time after SCLK Falling Edge | | 4 | | ns (typ) |
| t_{DS} | DIN Setup Time prior to SCLK Rising Edge | | 3 | 10 | ns (min) |
| t_{DH} | DIN Hold Time after SCLK Rising Edge | | 3 | 10 | ns (min) |
| t_{CH} | SCLK High Time | | | $0.4 \times t_{SCLK}$ | ns (min) |
| t_{CL} | SCLK Low Time | | | $0.4 \times t_{SCLK}$ | ns (min) |
| t_{DIS} | \overline{CS} Rising Edge to DOUT High-Impedance | DOUT falling | 2.4 | 20 | ns (max) |
| | | DOUT rising | 0.9 | 20 | ns (max) |

(1) Tested limits are ensured to TI's AOQL (Average Outgoing Quality Level).

Timing Diagrams

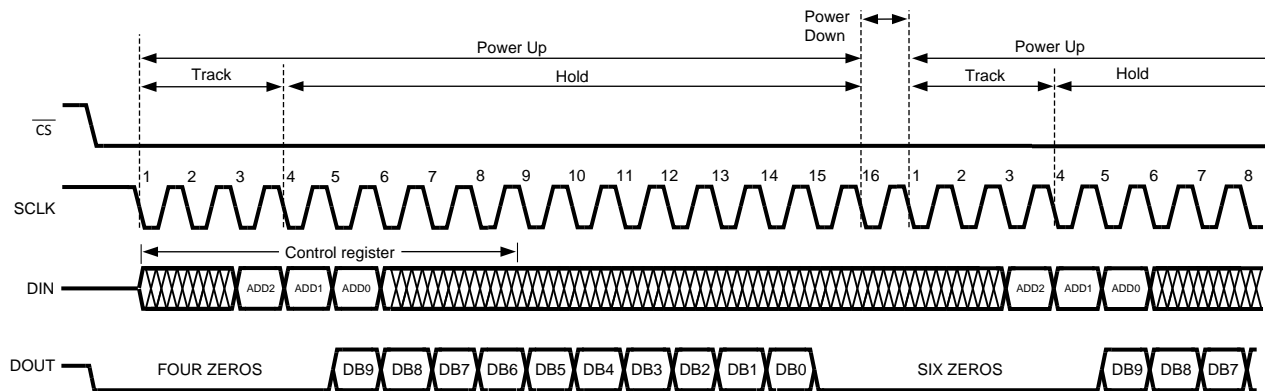

Figure 2. ADC088S102 Operational Timing Diagram

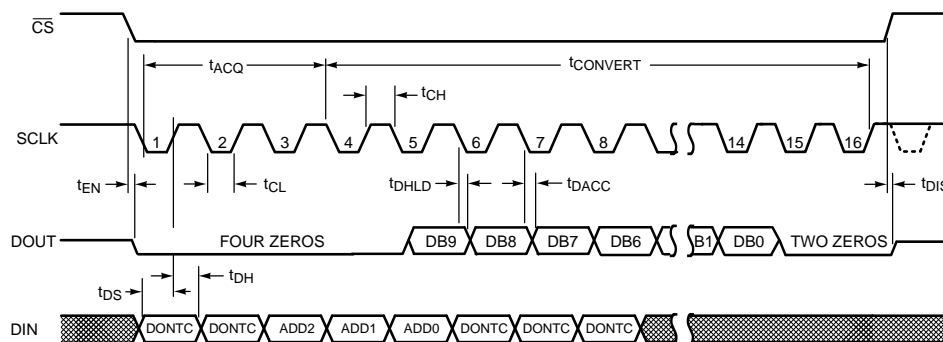

Figure 3. ADC088S102 Serial Timing Diagram

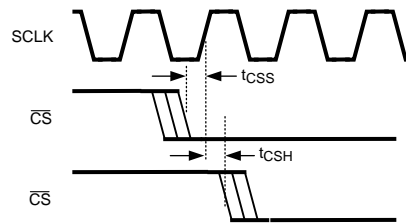

Figure 4. SCLK and \overline{CS} Timing Parameters

Specification Definitions

ACQUISITION TIME is the time required for the ADC to acquire the input voltage. During this time, the hold capacitor is charged by the input voltage.

APERTURE DELAY is the time between the fourth falling edge of SCLK and the time when the input signal is internally acquired or held for conversion.

CONVERSION TIME is the time required, after the input voltage is acquired, for the ADC to convert the input voltage to a digital word.

CHANNEL-TO-CHANNEL ISOLATION is resistance to coupling of energy from one channel into another channel.

CROSSTALK is the coupling of energy from one channel into another channel. This is similar to Channel-to-Channel Isolation, except for the sign of the data.

DIFFERENTIAL NON-LINEARITY (DNL) is the measure of the maximum deviation from the ideal step size of 1 LSB.

DUTY CYCLE is the ratio of the time that a repetitive digital waveform is high to the total time of one period. The specification here refers to the SCLK.

EFFECTIVE NUMBER OF BITS (ENOB, or EFFECTIVE BITS) is another method of specifying Signal-to-Noise and Distortion or SINAD. ENOB is defined as $(\text{SINAD} - 1.76) / 6.02$ and says that the converter is equivalent to a perfect ADC of this (ENOB) number of bits.

FULL POWER BANDWIDTH is a measure of the frequency at which the reconstructed output fundamental drops 3 dB below its low frequency value for a full scale input.

GAIN ERROR is the deviation of the last code transition (111...110) to (111...111) from the ideal ($V_{\text{REF}} - 1.5$ LSB), after adjusting for offset error.

INTEGRAL NON-LINEARITY (INL) is a measure of the deviation of each individual code from a line drawn from negative full scale ($\frac{1}{2}$ LSB below the first code transition) through positive full scale ($\frac{1}{2}$ LSB above the last code transition). The deviation of any given code from this straight line is measured from the center of that code value.

INTERMODULATION DISTORTION (IMD) is the creation of additional spectral components as a result of two sinusoidal frequencies being applied to an individual ADC input at the same time. It is defined as the ratio of the power in either the second or the third order intermodulation products to the sum of the power in both of the original frequencies. Second order products are $f_a \pm f_b$, where f_a and f_b are the two sine wave input frequencies. Third order products are $(2f_a \pm f_b)$ and $(f_a \pm 2f_b)$. IMD is usually expressed in dB.

MISSING CODES are those output codes that will never appear at the ADC outputs. The ADC088S102 is specified not to have any missing codes.

OFFSET ERROR is the deviation of the first code transition (000...000) to (000...001) from the ideal (i.e. GND + 0.5 LSB).

SIGNAL TO NOISE RATIO (SNR) is the ratio, expressed in dB, of the rms value of the input signal to the rms value of the sum of all other spectral components below one-half the sampling frequency, not including harmonics or d.c.

SIGNAL TO NOISE PLUS DISTORTION (S/N+D or SINAD) Is the ratio, expressed in dB, of the rms value of the input signal to the rms value of all of the other spectral components below half the clock frequency, including harmonics but excluding d.c.

SPURIOUS FREE DYNAMIC RANGE (SFDR) is the difference, expressed in dB, between the rms values of the input signal and the peak spurious signal where a spurious signal is any signal present in the output spectrum that is not present at the input, including harmonics but excluding d.c.

TOTAL HARMONIC DISTORTION (THD) is the ratio, expressed in dBc, of the rms total of the first five harmonic components at the output to the rms level of the input signal frequency as seen at the output. THD is calculated as

$$\text{THD} = 20 \times \log_{10} \sqrt{\frac{A_{f2}^2 + \dots + A_{f6}^2}{A_{f1}^2}}$$

where

- A_{f1} is the RMS power of the input frequency at the output and A_{f2} through A_{f6} are the RMS power in the first 5 harmonic frequencies.

THROUGHPUT TIME is the minimum time required between the start of two successive conversions. It is the acquisition time plus the conversion time.

Typical Performance Characteristics

$V_A = V_D = +5.0V$, $T_A = +25^\circ C$, $f_{SAMPLE} = 1$ MSPS, $f_{SCLK} = 16$ MHz, $f_{IN} = 40.2$ kHz unless otherwise stated.

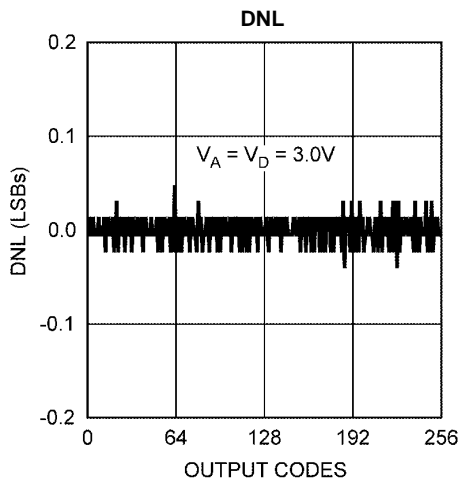

Figure 5.

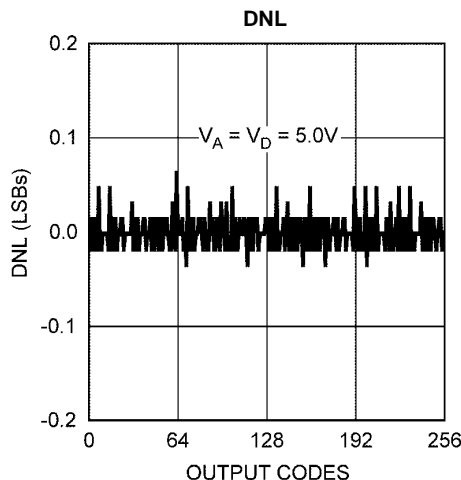

Figure 6.

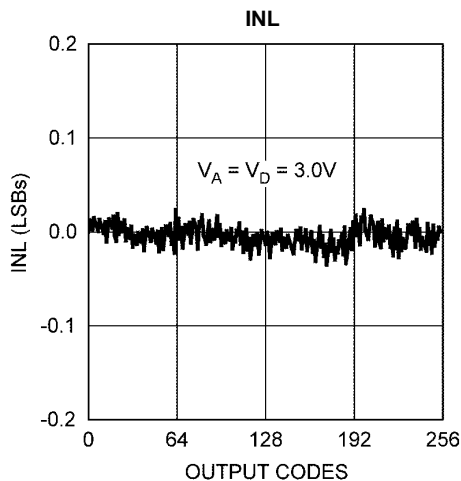

Figure 7.

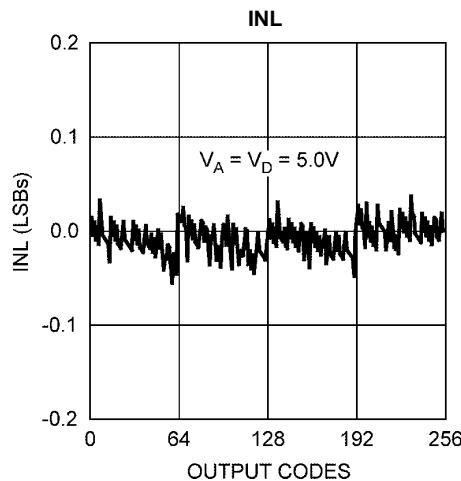

Figure 8.

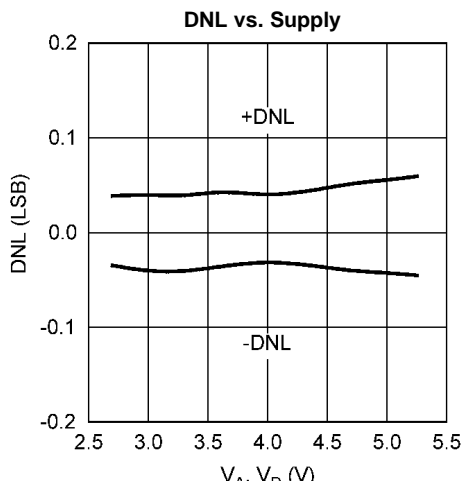

Figure 9.

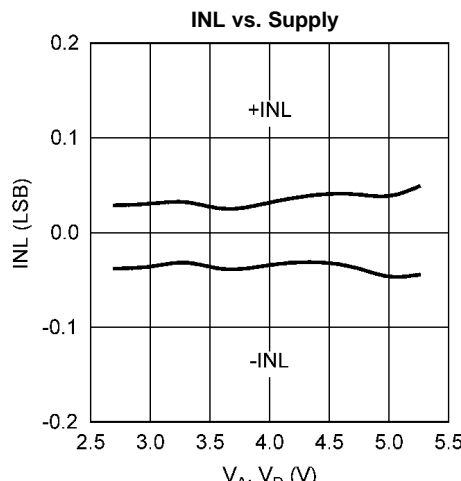

Figure 10.

Typical Performance Characteristics (continued)

$V_A = V_D = +5.0V$, $T_A = +25^\circ C$, $f_{SAMPLE} = 1$ MSPS, $f_{SCLK} = 16$ MHz, $f_{IN} = 40.2$ kHz unless otherwise stated.

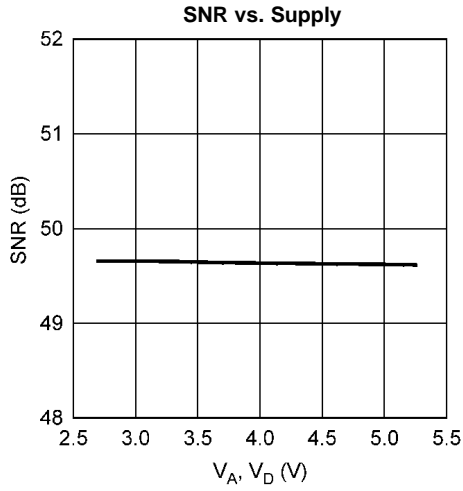

Figure 11.

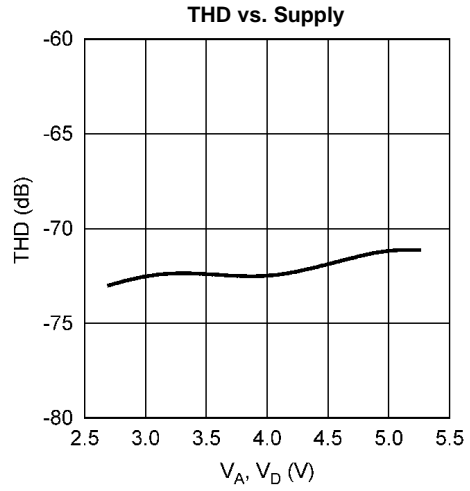

Figure 12.

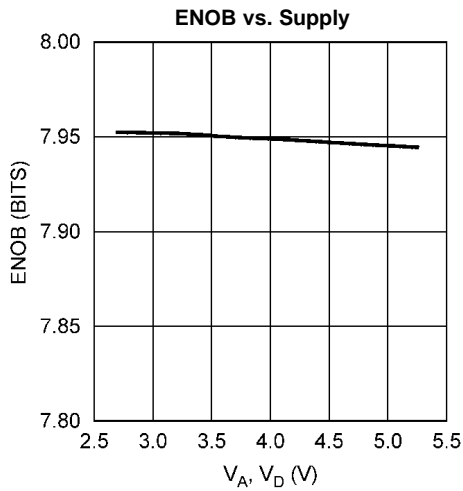

Figure 13.

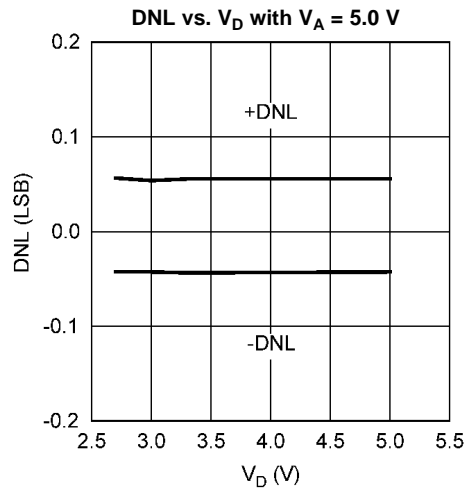

Figure 14.

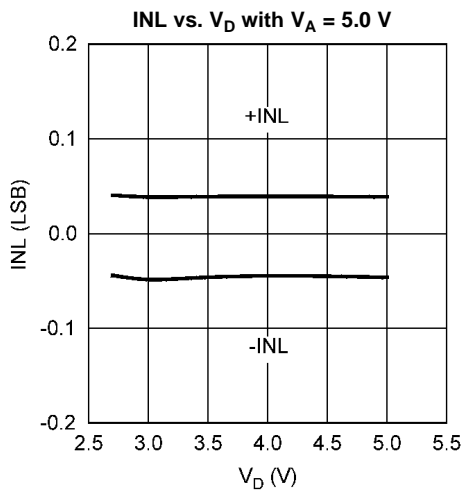

Figure 15.

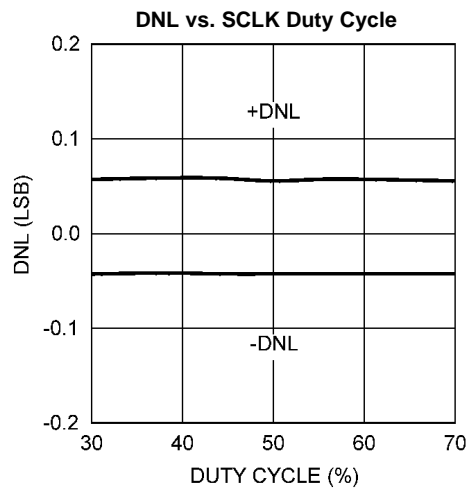

Figure 16.

Typical Performance Characteristics (continued)

$V_A = V_D = +5.0V$, $T_A = +25^\circ C$, $f_{SAMPLE} = 1 \text{ MSPS}$, $f_{SCLK} = 16 \text{ MHz}$, $f_{IN} = 40.2 \text{ kHz}$ unless otherwise stated.

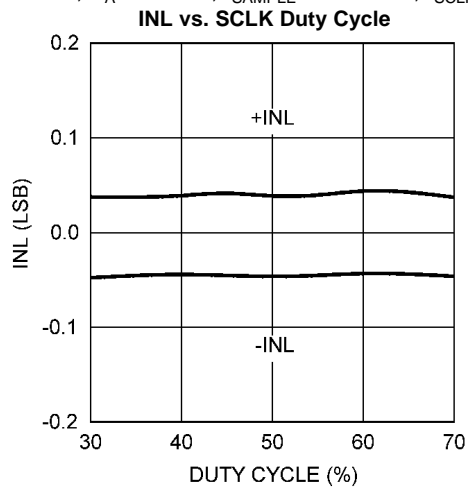

Figure 17.

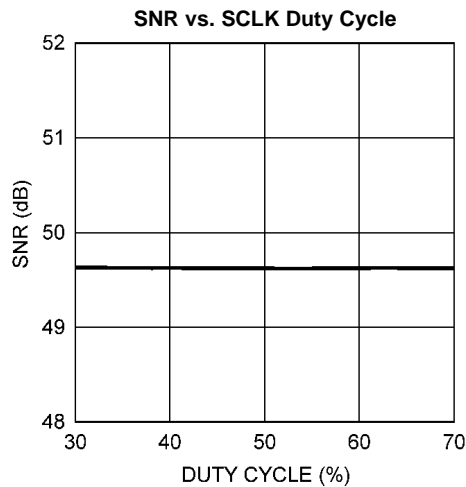

Figure 18.

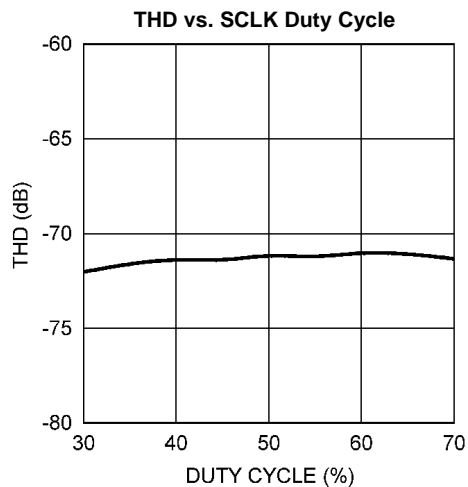

Figure 19.

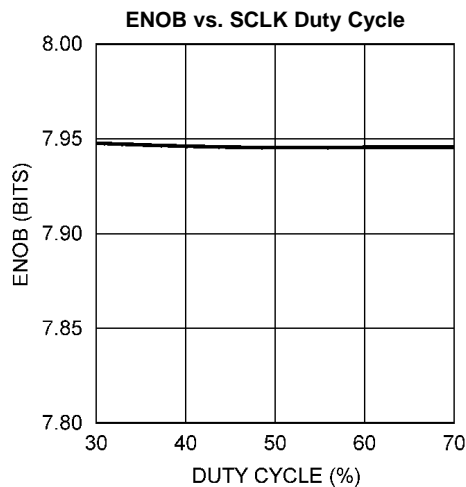

Figure 20.

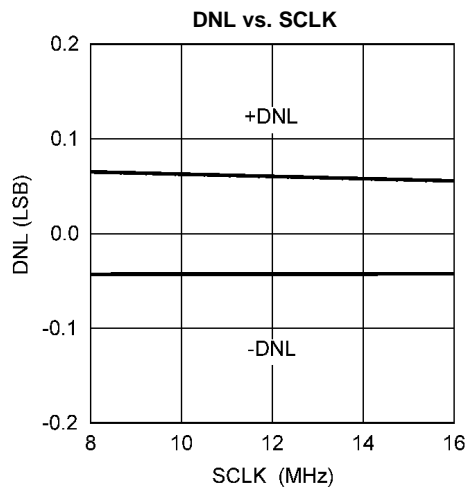

Figure 21.

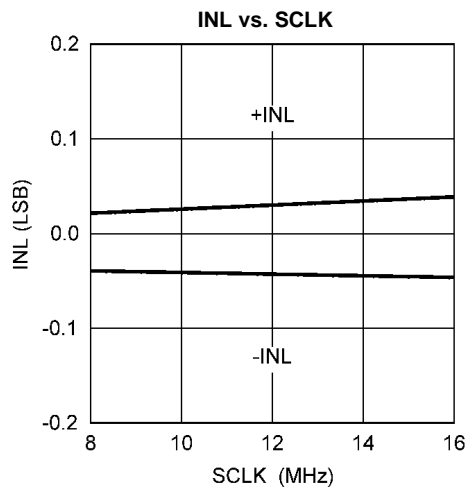

Figure 22.

Typical Performance Characteristics (continued)

$V_A = V_D = +5.0V$, $T_A = +25^\circ C$, $f_{SAMPLE} = 1 \text{ MSPS}$, $f_{SCLK} = 16 \text{ MHz}$, $f_{IN} = 40.2 \text{ kHz}$ unless otherwise stated.

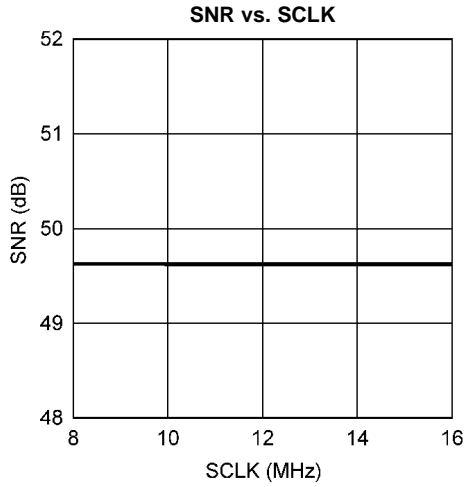

Figure 23.

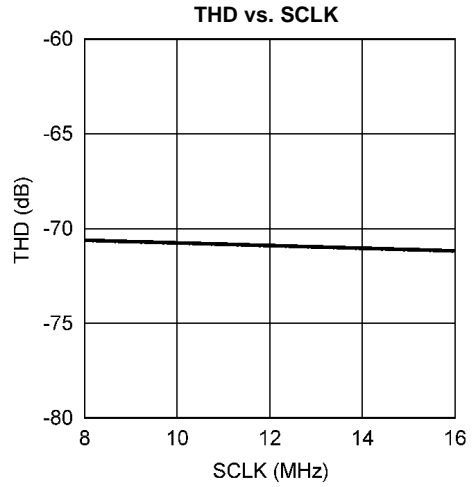

Figure 24.

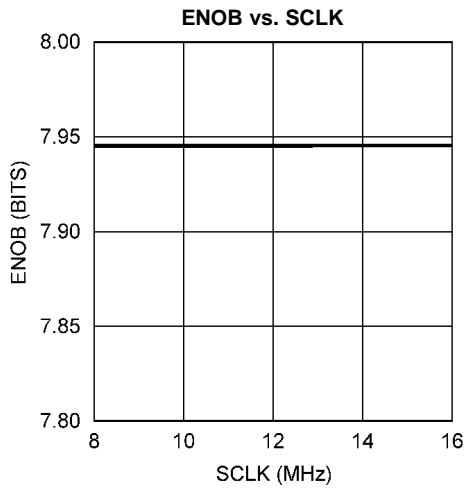

Figure 25.

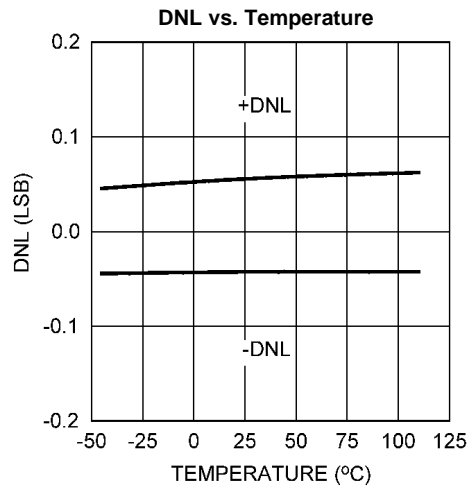

Figure 26.

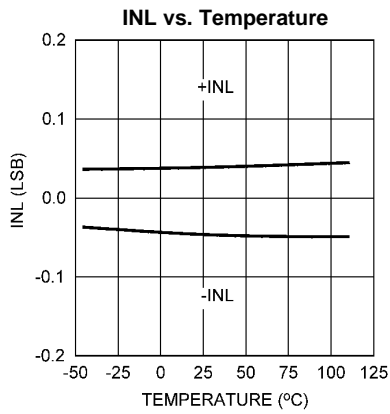

Figure 27.

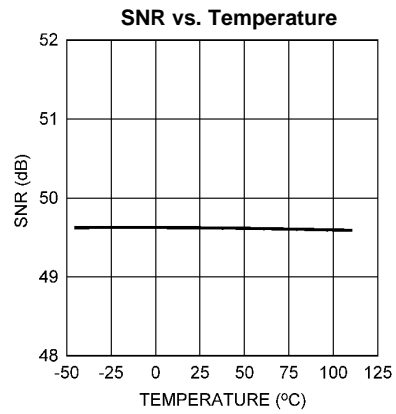

Figure 28.

Typical Performance Characteristics (continued)

$V_A = V_D = +5.0V$, $T_A = +25^\circ C$, $f_{SAMPLE} = 1 \text{ MSPS}$, $f_{SCLK} = 16 \text{ MHz}$, $f_{IN} = 40.2 \text{ kHz}$ unless otherwise stated.

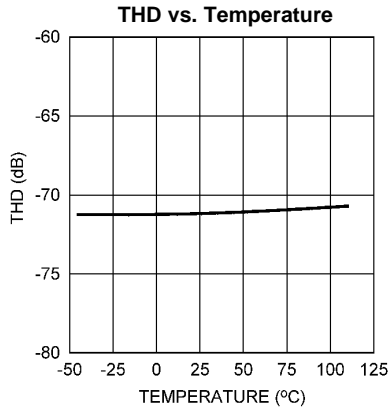

Figure 29.

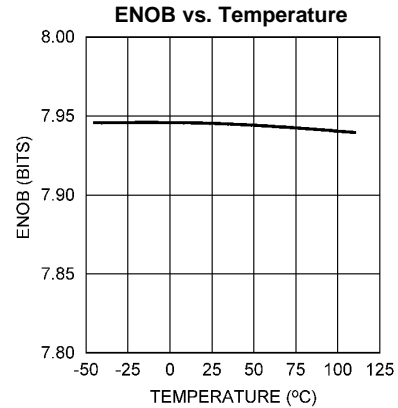

Figure 30.

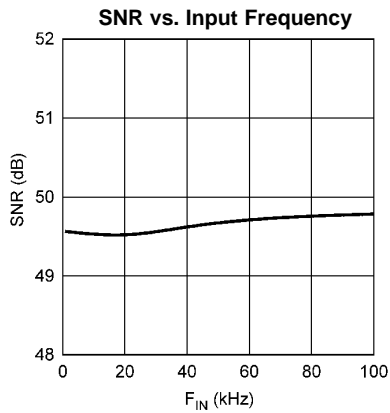

Figure 31.

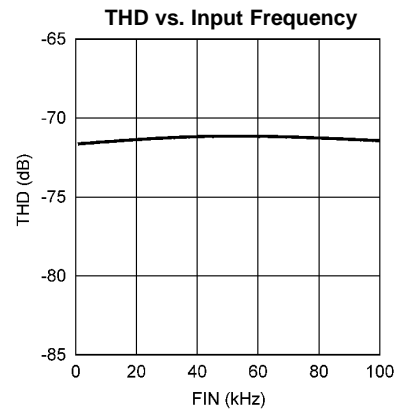

Figure 32.

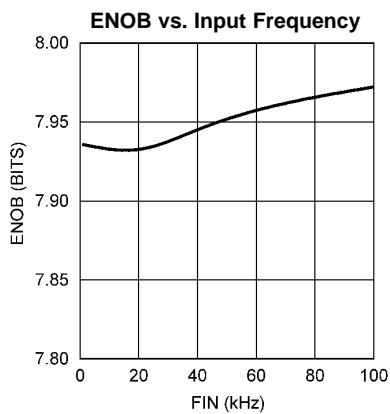

Figure 33.

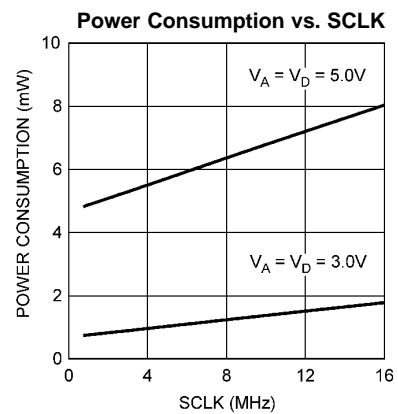

Figure 34.

FUNCTIONAL DESCRIPTION

The ADC088S102 is a successive-approximation analog-to-digital converter designed around a charge-redistribution digital-to-analog converter.

ADC088S102 OPERATION

Simplified schematics of the ADC088S102 in both track and hold operation are shown in [Figure 35](#) and [Figure 36](#) respectively. In [Figure 35](#), the ADC088S102 is in track mode: switch SW1 connects the sampling capacitor to one of eight analog input channels through the multiplexer, and SW2 balances the comparator inputs. The ADC088S102 is in this state for the first three SCLK cycles after \overline{CS} is brought low.

[Figure 36](#) shows the ADC088S102 in hold mode: switch SW1 connects the sampling capacitor to ground, maintaining the sampled voltage, and switch SW2 unbalances the comparator. The control logic then instructs the charge-redistribution DAC to add or subtract fixed amounts of charge to or from the sampling capacitor until the comparator is balanced. When the comparator is balanced, the digital word supplied to the DAC is the digital representation of the analog input voltage. The ADC088S102 is in this state for the last thirteen SCLK cycles after \overline{CS} is brought low.

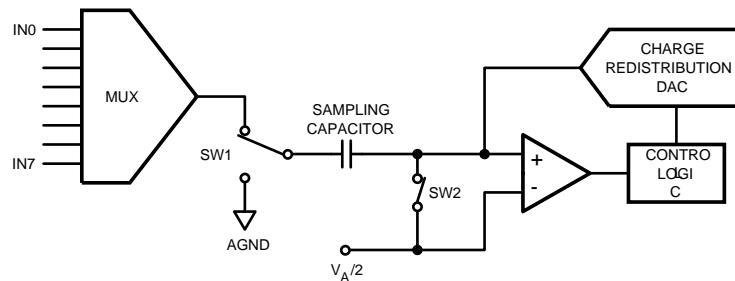

Figure 35. ADC088S102 in Track Mode

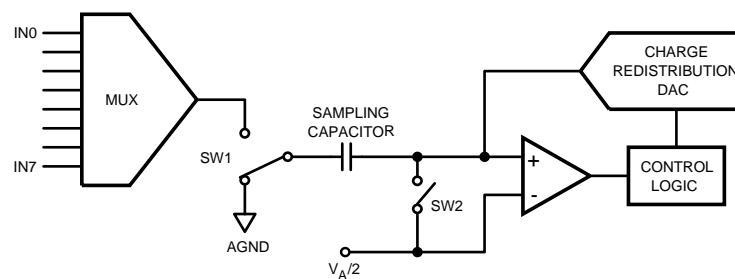

Figure 36. ADC088S102 in Hold Mode

SERIAL INTERFACE

An operational timing diagram and a serial interface timing diagram for the ADC088S102 are shown in The Timing Diagrams section. \overline{CS} , chip select, initiates conversions and frames the serial data transfers. SCLK (serial clock) controls both the conversion process and the timing of serial data. DOUT is the serial data output pin, where a conversion result is sent as a serial data stream, MSB first. Data to be written to the ADC088S102's Control Register is placed on DIN, the serial data input pin. New data is written to DIN with each conversion.

A serial frame is initiated on the falling edge of \overline{CS} and ends on the rising edge of \overline{CS} . Each frame must contain an integer multiple of 16 rising SCLK edges. The ADC's DOUT pin is in a high impedance state when \overline{CS} is high and is active when \overline{CS} is low. Thus, \overline{CS} acts as an output enable. Similarly, SCLK is internally gated off when \overline{CS} is brought high.

During the first 3 cycles of SCLK, the ADC is in the track mode, acquiring the input voltage. For the next 13 SCLK cycles the conversion is accomplished and the data is clocked out. SCLK falling edges 1 through 4 clock out leading zeros, falling edges 5 through 12 clock out the conversion result, MSB first, and falling edges 13 through 16 clock out trailing zeros. If there is more than one conversion in a frame (continuous conversion mode), the ADC will re-enter the track mode on the falling edge of SCLK after the N*16th rising edge of SCLK and re-enter the hold/convert mode on the N*16+4th falling edge of SCLK. "N" is an integer value.

The ADC088S102 enters track mode under three different conditions. In [Figure 2](#), \overline{CS} goes low with SCLK high and the ADC enters track mode on the first falling edge of SCLK. In the second condition, \overline{CS} goes low with SCLK low. Under this condition, the ADC automatically enters track mode and the falling edge of \overline{CS} is seen as the first falling edge of SCLK. In the third condition, \overline{CS} and SCLK go low simultaneously and the ADC enters track mode. While there is no timing restriction with respect to the falling edges of \overline{CS} and SCLK, see [Figure 4](#) for setup and hold time requirements for the falling edge of \overline{CS} with respect to the rising edge of SCLK.

During each conversion, data is clocked into a control register through the DIN pin on the first 8 rising edges of SCLK after the fall of \overline{CS} . The control register is loaded with data indicating the input channel to be converted on the subsequent conversion (see [Table 1](#) [Table 2](#) [Table 3](#)).

The user does not need to incorporate a power-up delay or dummy conversions as the ADC088S102 is able to acquire the input signal to full resolution in the first conversion immediately following power-up. The first conversion result after power-up will be that of IN0.

Table 1. Control Register Bits

| Bit 7 (MSB) | Bit 6 | Bit 5 | Bit 4 | Bit 3 | Bit 2 | Bit 1 | Bit 0 |
|-------------|-------|-------|-------|-------|-------|-------|-------|
| DONTC | DONTC | ADD2 | ADD1 | ADD0 | DONTC | DONTC | DONTC |

Table 2. Control Register Bit Descriptions

| Bit #: | Symbol: | Description |
|---------------|---------|---|
| 7, 6, 2, 1, 0 | DONTC | Don't care. The values of these bits do not affect the device. |
| 5 | ADD2 | These three bits determine which input channel will be sampled and converted at the next conversion cycle. The mapping between codes and channels is shown in Table 3 . |
| 4 | ADD1 | |
| 3 | ADD0 | |

Table 3. Input Channel Selection

| ADD2 | ADD1 | ADD0 | Input Channel |
|------|------|------|---------------|
| 0 | 0 | 0 | IN0 (Default) |
| 0 | 0 | 1 | IN1 |
| 0 | 1 | 0 | IN2 |
| 0 | 1 | 1 | IN3 |
| 1 | 0 | 0 | IN4 |
| 1 | 0 | 1 | IN5 |
| 1 | 1 | 0 | IN6 |
| 1 | 1 | 1 | IN7 |

ADC088S102 TRANSFER FUNCTION

The output format of the ADC088S102 is straight binary. Code transitions occur midway between successive integer LSB values. The LSB width for the ADC088S102 is $V_A / 256$. The ideal transfer characteristic is shown in [Figure 37](#). The transition from an output code of 0000 0000 to a code of 0000 0001 is at 1/2 LSB, or a voltage of $V_A / 512$. Other code transitions occur at steps of one LSB.

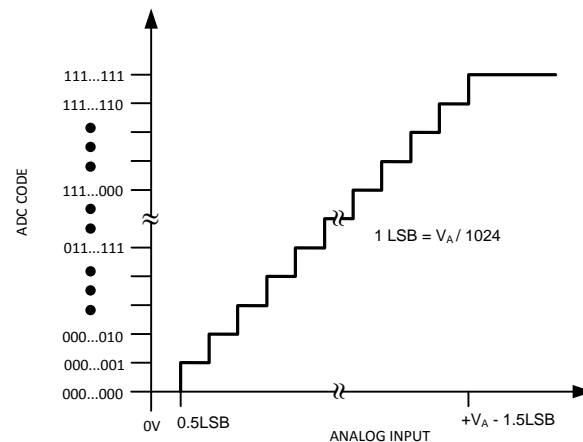

Figure 37. Ideal Transfer Characteristic

ANALOG INPUTS

An equivalent circuit for one of the ADC088S102's input channels is shown in [Figure 38](#). Diodes D1 and D2 provide ESD protection for the analog inputs. The operating range for the analog inputs is 0 V to V_A . Going beyond this range will cause the ESD diodes to conduct and result in erratic operation.

The capacitor C1 in [Figure 38](#) has a typical value of 3 pF and is mainly the package pin capacitance. Resistor R1 is the on resistance of the multiplexer and track / hold switch and is typically 500 ohms. Capacitor C2 is the ADC088S102 sampling capacitor, and is typically 30 pF. The ADC088S102 will deliver best performance when driven by a low-impedance source (less than 100 ohms). This is especially important when using the ADC088S102 to sample dynamic signals. Also important when sampling dynamic signals is a band-pass or low-pass filter which reduces harmonics and noise in the input. These filters are often referred to as anti-aliasing filters.

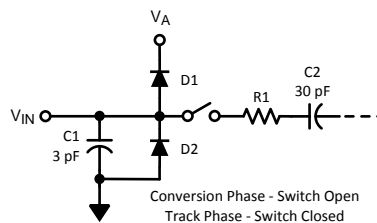

Figure 38. Equivalent Input Circuit

DIGITAL INPUTS AND OUTPUTS

The ADC088S102's digital inputs (SCLK, \overline{CS} , and DIN) have an operating range of 0 V to V_A . They are not prone to latch-up and may be asserted before the digital supply (V_D) without any risk. The digital output (DOUT) operating range is controlled by V_D . The output high voltage is $V_D - 0.5V$ (min) while the output low voltage is 0.4V (max).

Applications Information

TYPICAL APPLICATION CIRCUIT

A typical application is shown in [Figure 39](#). The split analog and digital supply pins are both powered in this example by the TI LP2950 low-dropout voltage regulator. The analog supply is bypassed with a capacitor network located close to the ADC088S102. The digital supply is separated from the analog supply by an isolation resistor and bypassed with additional capacitors. The ADC088S102 uses the analog supply (V_A) as its reference voltage, so it is very important that V_A be kept as clean as possible. Due to the low power requirements of the ADC088S102, it is also possible to use a precision reference as a power supply.

To minimize the error caused by the changing input capacitance of the ADC088S102, a capacitor is connected from each input pin to ground. The capacitor, which is much larger than the input capacitance of the ADC088S102 when in track mode, provides the current to quickly charge the sampling capacitor of the ADC088S102. An isolation resistor is added to isolate the load capacitance from the input source.

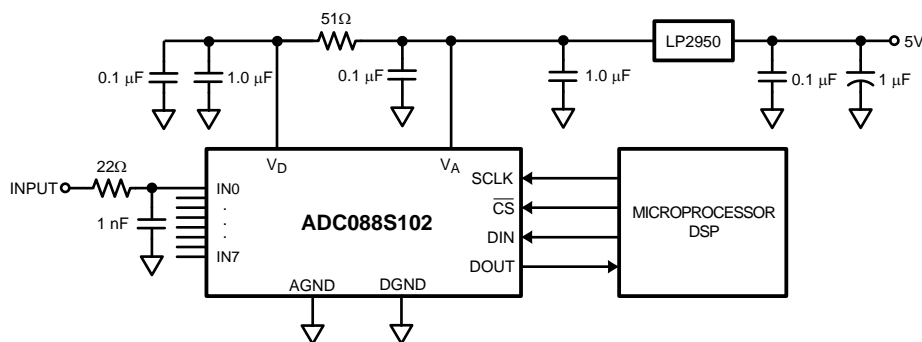

Figure 39. Typical Application Circuit

POWER SUPPLY CONSIDERATIONS

There are three major power supply concerns with this product: power supply sequencing, power management, and the effect of digital supply noise on the analog supply.

Power Supply Sequence

The ADC088S102 is a dual-supply device. The two supply pins share ESD resources, so care must be exercised to ensure that the power is applied in the correct sequence. To avoid turning on the ESD diodes, the digital supply (V_D) cannot exceed the analog supply (V_A) by more than 300 mV, not even on a transient basis. Therefore, V_A must ramp up before or concurrently with V_D .

Power Management

The ADC088S102 is fully powered-up whenever \overline{CS} is low and fully powered-down whenever \overline{CS} is high, with one exception. If operating in continuous conversion mode, the ADC088S102 automatically enters power-down mode between SCLK's 16th falling edge of a conversion and the SCLK's 1st falling edge of the subsequent conversion (see [Figure 2](#)).

In continuous conversion mode, the ADC088S102 can perform multiple conversions back to back. Each conversion requires 16 SCLK cycles and the ADC088S102 will perform conversions continuously as long as \overline{CS} is held low. Continuous mode offers maximum throughput.

In burst mode, the user may trade off throughput for power consumption by performing fewer conversions per unit time. This means spending more time in power-down mode and less time in normal mode. By utilizing this technique, the user can achieve very low sample rates while still utilizing an SCLK frequency within the electrical specifications. The Power Consumption vs. SCLK curve in the Typical Performance Curves section shows the typical power consumption of the ADC088S102. To calculate the power consumption (P_C), simply multiply the fraction of time spent in the normal mode (t_N) by the normal mode power consumption (P_N), and add the fraction of time spent in shutdown mode (t_S) multiplied by the shutdown mode power consumption (P_S) as shown in [Figure 40](#).

$$P_C = \frac{t_N}{t_N + t_S} \times P_N + \frac{t_S}{t_N + t_S} \times P_S$$

Figure 40. Power Consumption Equation

Power Supply Noise Considerations

The charging of any output load capacitance requires current from the digital supply, V_D . The current pulses required from the supply to charge the output capacitance will cause voltage variations on the digital supply. If these variations are large enough, they could degrade SNR and SINAD performance of the ADC. Furthermore, if the analog and digital supplies are tied directly together, the noise on the digital supply will be coupled directly into the analog supply, causing greater performance degradation than would noise on the digital supply alone. Similarly, discharging the output capacitance when the digital output goes from a logic high to a logic low will dump current into the die substrate, which is resistive. Load discharge currents will cause "ground bounce" noise in the substrate that will degrade noise performance if that current is large enough. The larger the output capacitance, the more current flows through the die substrate and the greater the noise coupled into the analog channel.

The first solution to keeping digital noise out of the analog supply is to decouple the analog and digital supplies from each other or use separate supplies for them. To keep noise out of the digital supply, keep the output load capacitance as small as practical. If the load capacitance is greater than 50 pF, use a 100 Ω series resistor at the ADC output, located as close to the ADC output pin as practical. This will limit the charge and discharge current of the output capacitance and improve noise performance. Since the series resistor and the load capacitance form a low frequency pole, verify signal integrity once the series resistor has been added.

LAYOUT AND GROUNDING

Capacitive coupling between the noisy digital circuitry and the sensitive analog circuitry can lead to poor performance. The solution is to keep the analog circuitry separated from the digital circuitry and the clock line as short as possible.

Digital circuits create substantial supply and ground current transients. The logic noise generated could have significant impact upon system noise performance. To avoid performance degradation of the ADC088S102 due to supply noise, do not use the same supply for the ADC088S102 that is used for digital logic.

Generally, analog and digital lines should cross each other at 90° to avoid crosstalk. However, to maximize accuracy in high resolution systems, avoid crossing analog and digital lines altogether. It is important to keep clock lines as short as possible and isolated from ALL other lines, including other digital lines. In addition, the clock line should also be treated as a transmission line and be properly terminated.



The analog input should be isolated from noisy signal traces to avoid coupling of spurious signals into the input. Any external component (e.g., a filter capacitor) connected between the converter's input pins and ground or to the reference input pin and ground should be connected to a very clean point in the ground plane.

We recommend the use of a single, uniform ground plane and the use of split power planes. The power planes should be located within the same board layer. All analog circuitry (input amplifiers, filters, reference components, etc.) should be placed over the analog power plane. All digital circuitry and I/O lines should be placed over the digital power plane. Furthermore, all components in the reference circuitry and the input signal chain that are connected to ground should be connected together with short traces and enter the analog ground plane at a single, quiet point.

REVISION HISTORY

| Changes from Revision A (March 2013) to Revision B | Page |
|--|-----------------|
| <hr/> <ul style="list-style-type: none">• Changed layout of National Data Sheet to TI format | <hr/> 18 |

PACKAGING INFORMATION

| Orderable Device | Status (1) | Package Type | Package Drawing | Pins | Package Qty | Eco Plan (2) | Lead finish/ Ball material (6) | MSL Peak Temp (3) | Op Temp (°C) | Device Marking (4/5) | Samples |
|----------------------|---------------|--------------|-----------------|------|-------------|-----------------|--------------------------------------|----------------------|--------------|-------------------------|---|
| ADC088S102CIMT/NOPB | ACTIVE | TSSOP | PW | 16 | 92 | RoHS & Green | SN | Level-1-260C-UNLIM | -40 to 105 | 088S102 CIMT |  |
| ADC088S102CIMTX/NOPB | ACTIVE | TSSOP | PW | 16 | 2500 | RoHS & Green | SN | Level-1-260C-UNLIM | -40 to 105 | 088S102 CIMT |  |

(1) The marketing status values are defined as follows:

ACTIVE: Product device recommended for new designs.

LIFEBUY: TI has announced that the device will be discontinued, and a lifetime-buy period is in effect.

NRND: Not recommended for new designs. Device is in production to support existing customers, but TI does not recommend using this part in a new design.

PREVIEW: Device has been announced but is not in production. Samples may or may not be available.

OBSOLETE: TI has discontinued the production of the device.

(2) **RoHS:** TI defines "RoHS" to mean semiconductor products that are compliant with the current EU RoHS requirements for all 10 RoHS substances, including the requirement that RoHS substance do not exceed 0.1% by weight in homogeneous materials. Where designed to be soldered at high temperatures, "RoHS" products are suitable for use in specified lead-free processes. TI may reference these types of products as "Pb-Free".

RoHS Exempt: TI defines "RoHS Exempt" to mean products that contain lead but are compliant with EU RoHS pursuant to a specific EU RoHS exemption.

Green: TI defines "Green" to mean the content of Chlorine (Cl) and Bromine (Br) based flame retardants meet JS709B low halogen requirements of <=1000ppm threshold. Antimony trioxide based flame retardants must also meet the <=1000ppm threshold requirement.

(3) MSL, Peak Temp. - The Moisture Sensitivity Level rating according to the JEDEC industry standard classifications, and peak solder temperature.

(4) There may be additional marking, which relates to the logo, the lot trace code information, or the environmental category on the device.

(5) Multiple Device Markings will be inside parentheses. Only one Device Marking contained in parentheses and separated by a "~" will appear on a device. If a line is indented then it is a continuation of the previous line and the two combined represent the entire Device Marking for that device.

(6) Lead finish/Ball material - Orderable Devices may have multiple material finish options. Finish options are separated by a vertical ruled line. Lead finish/Ball material values may wrap to two lines if the finish value exceeds the maximum column width.

Important Information and Disclaimer:The information provided on this page represents TI's knowledge and belief as of the date that it is provided. TI bases its knowledge and belief on information provided by third parties, and makes no representation or warranty as to the accuracy of such information. Efforts are underway to better integrate information from third parties. TI has taken and continues to take reasonable steps to provide representative and accurate information but may not have conducted destructive testing or chemical analysis on incoming materials and chemicals. TI and TI suppliers consider certain information to be proprietary, and thus CAS numbers and other limited information may not be available for release.

In no event shall TI's liability arising out of such information exceed the total purchase price of the TI part(s) at issue in this document sold by TI to Customer on an annual basis.

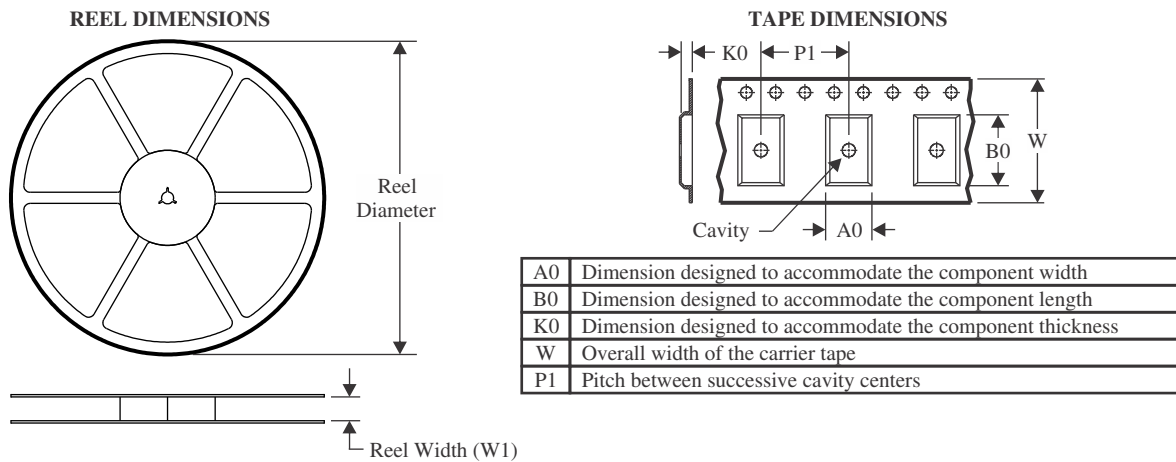
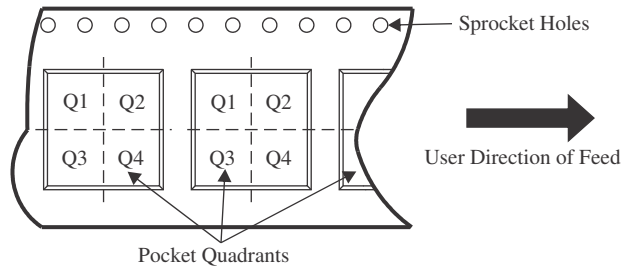
TAPE AND REEL INFORMATION

QUADRANT ASSIGNMENTS FOR PIN 1 ORIENTATION IN TAPE

*All dimensions are nominal

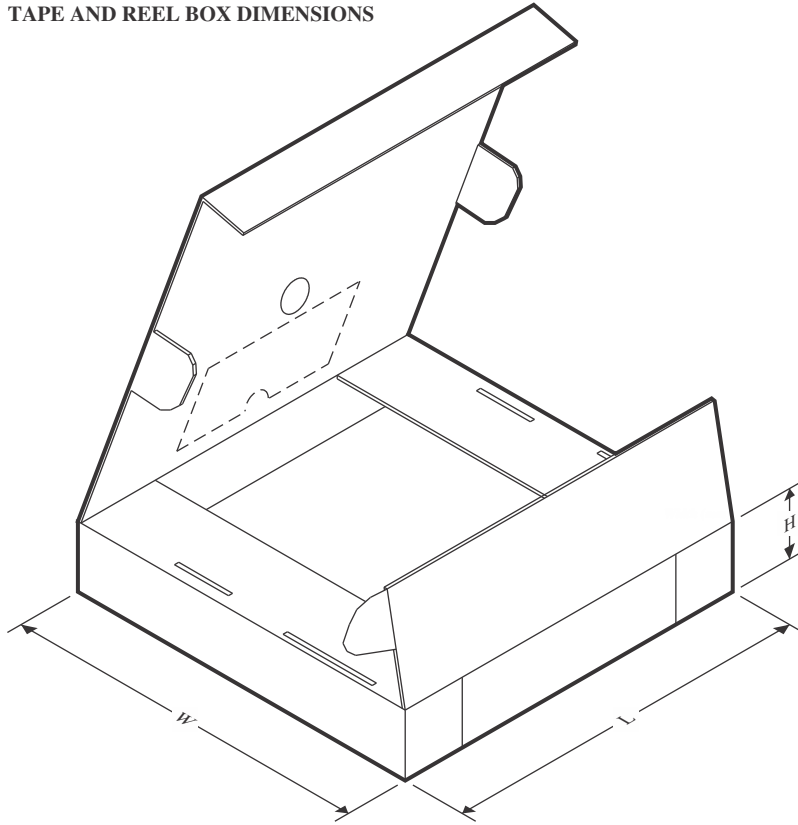
| Device | Package Type | Package Drawing | Pins | SPQ | Reel Diameter (mm) | Reel Width W1 (mm) | A0 (mm) | B0 (mm) | K0 (mm) | P1 (mm) | W (mm) | Pin1 Quadrant |
|----------------------|--------------|-----------------|------|------|--------------------|--------------------|---------|---------|---------|---------|--------|---------------|
| ADC088S102CIMTX/NOPB | TSSOP | PW | 16 | 2500 | 330.0 | 12.4 | 6.95 | 5.6 | 1.6 | 8.0 | 12.0 | Q1 |

TAPE AND REEL BOX DIMENSIONS

*All dimensions are nominal

| Device | Package Type | Package Drawing | Pins | SPQ | Length (mm) | Width (mm) | Height (mm) |
|--------------------------|--------------|-----------------|------|------|-------------|------------|-------------|
| ADC088S102CIMTX/ NOPB | TSSOP | PW | 16 | 2500 | 367.0 | 367.0 | 35.0 |

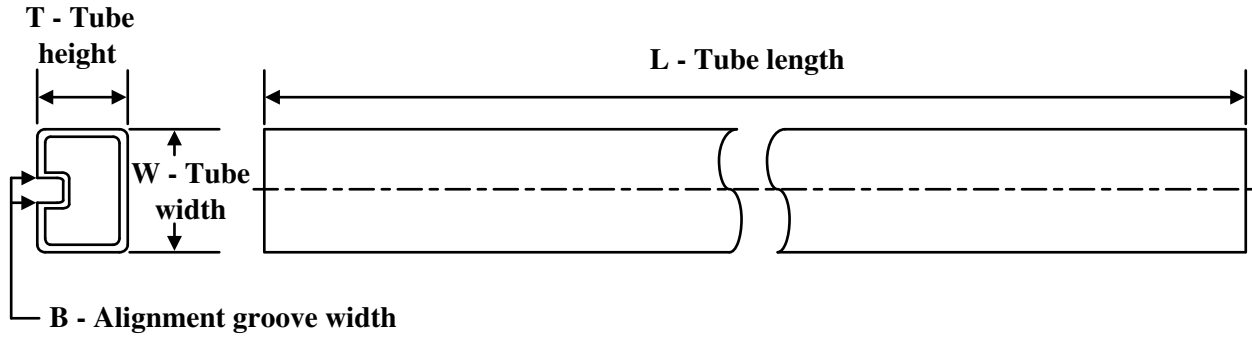
TUBE

*All dimensions are nominal

| Device | Package Name | Package Type | Pins | SPQ | L (mm) | W (mm) | T (μm) | B (mm) |
|---------------------|--------------|--------------|------|-----|--------|--------|--------|--------|
| ADC088S102CIMT/NOPB | PW | TSSOP | 16 | 92 | 495 | 8 | 2514.6 | 4.06 |

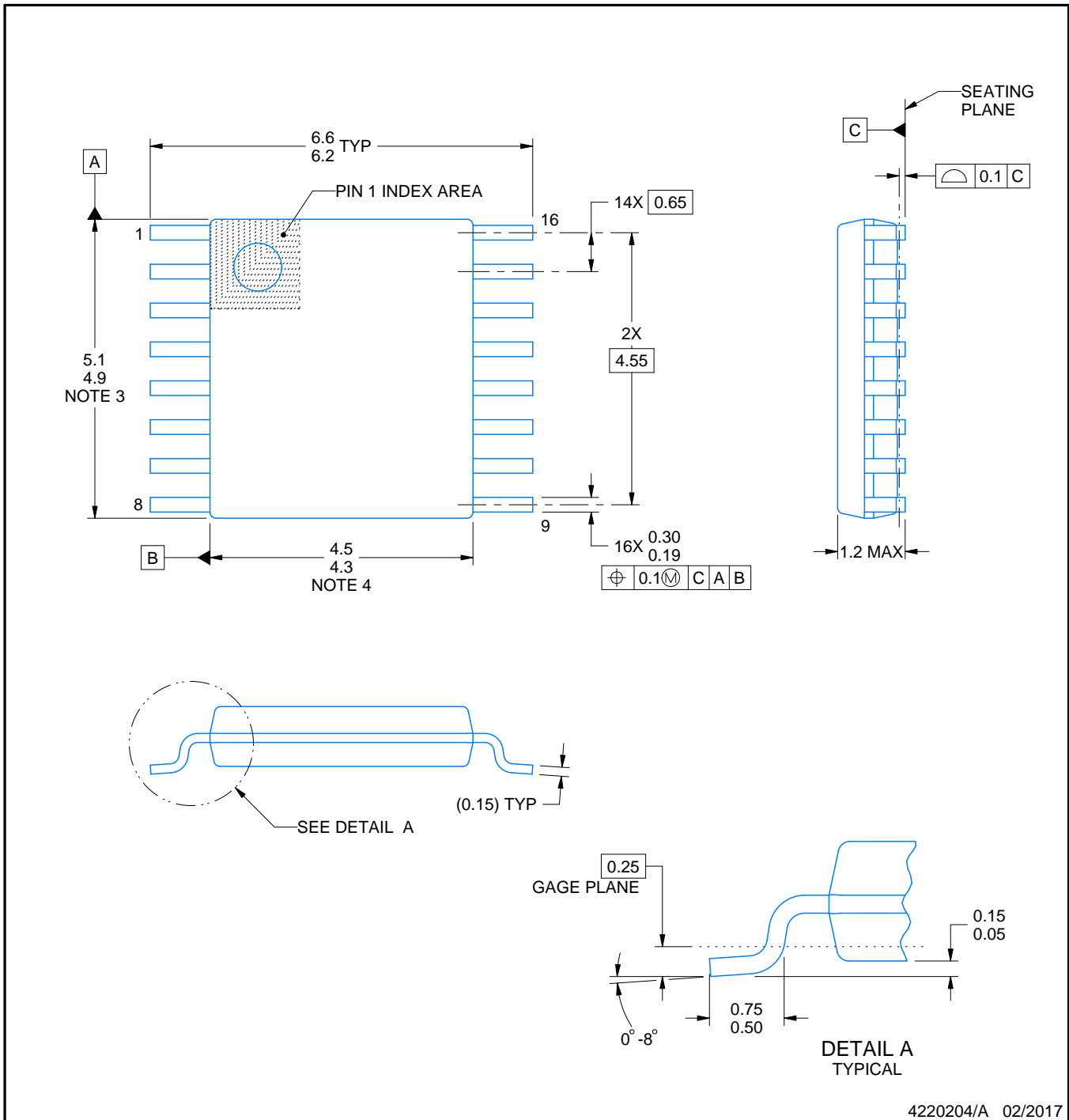

4220204/A 02/2017

NOTES:

1. All linear dimensions are in millimeters. Any dimensions in parenthesis are for reference only. Dimensioning and tolerancing per ASME Y14.5M.
2. This drawing is subject to change without notice.
3. This dimension does not include mold flash, protrusions, or gate burrs. Mold flash, protrusions, or gate burrs shall not exceed 0.15 mm per side.
4. This dimension does not include interlead flash. Interlead flash shall not exceed 0.25 mm per side.
5. Reference JEDEC registration MO-153.

EXAMPLE BOARD LAYOUT

PW0016A

TSSOP - 1.2 mm max height

SMALL OUTLINE PACKAGE

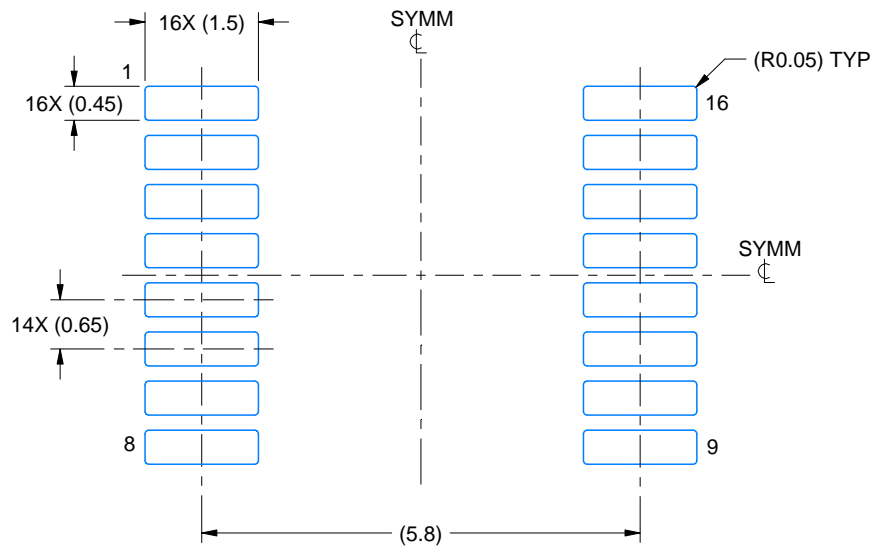

LAND PATTERN EXAMPLE
EXPOSED METAL SHOWN
SCALE: 10X

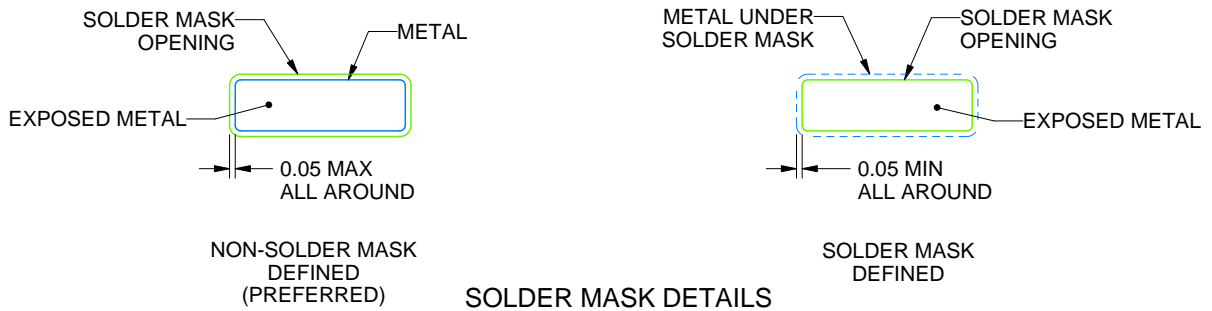

SOLDER MASK DETAILS

4220204/A 02/2017

NOTES: (continued)

- 6. Publication IPC-7351 may have alternate designs.
- 7. Solder mask tolerances between and around signal pads can vary based on board fabrication site.

EXAMPLE STENCIL DESIGN

PW0016A

TSSOP - 1.2 mm max height

SMALL OUTLINE PACKAGE

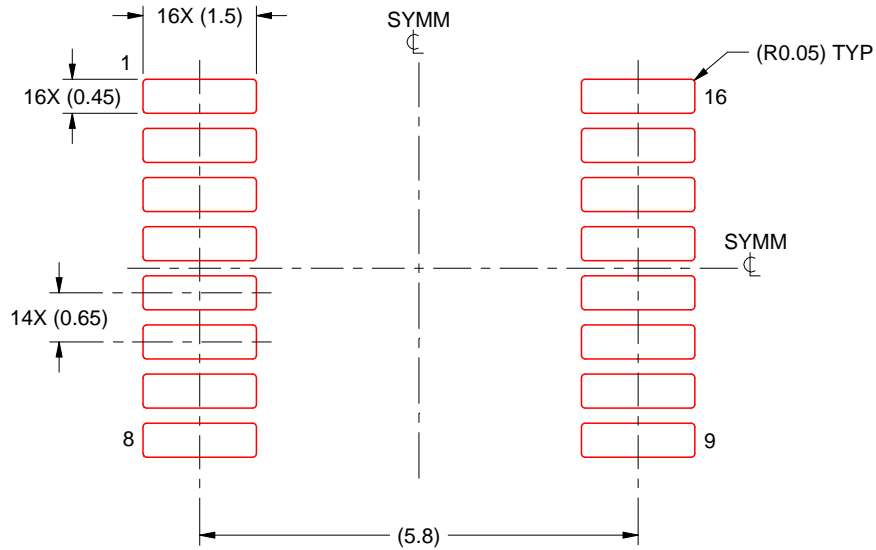

SOLDER PASTE EXAMPLE
BASED ON 0.125 mm THICK STENCIL
SCALE: 10X

4220204/A 02/2017

NOTES: (continued)

8. Laser cutting apertures with trapezoidal walls and rounded corners may offer better paste release. IPC-7525 may have alternate design recommendations.
9. Board assembly site may have different recommendations for stencil design.

IMPORTANT NOTICE AND DISCLAIMER

TI PROVIDES TECHNICAL AND RELIABILITY DATA (INCLUDING DATA SHEETS), DESIGN RESOURCES (INCLUDING REFERENCE DESIGNS), APPLICATION OR OTHER DESIGN ADVICE, WEB TOOLS, SAFETY INFORMATION, AND OTHER RESOURCES "AS IS" AND WITH ALL FAULTS, AND DISCLAIMS ALL WARRANTIES, EXPRESS AND IMPLIED, INCLUDING WITHOUT LIMITATION ANY IMPLIED WARRANTIES OF MERCHANTABILITY, FITNESS FOR A PARTICULAR PURPOSE OR NON-INFRINGEMENT OF THIRD PARTY INTELLECTUAL PROPERTY RIGHTS.

These resources are intended for skilled developers designing with TI products. You are solely responsible for (1) selecting the appropriate TI products for your application, (2) designing, validating and testing your application, and (3) ensuring your application meets applicable standards, and any other safety, security, regulatory or other requirements.

These resources are subject to change without notice. TI grants you permission to use these resources only for development of an application that uses the TI products described in the resource. Other reproduction and display of these resources is prohibited. No license is granted to any other TI intellectual property right or to any third party intellectual property right. TI disclaims responsibility for, and you will fully indemnify TI and its representatives against, any claims, damages, costs, losses, and liabilities arising out of your use of these resources.

TI's products are provided subject to [TI's Terms of Sale](#) or other applicable terms available either on ti.com or provided in conjunction with such TI products. TI's provision of these resources does not expand or otherwise alter TI's applicable warranties or warranty disclaimers for TI products.

TI objects to and rejects any additional or different terms you may have proposed.

Mailing Address: Texas Instruments, Post Office Box 655303, Dallas, Texas 75265
Copyright © 2022, Texas Instruments Incorporated