

MATERIALS AND FINISHES

BODY, BRASS
PLATED NICKEL

CENTER CONTACT, BRASS
PLATED GOLD

CRIMP TUBE BRASS
PLATED NICKEL

SHROUD: PBT OR NYLON 66
KEYING SEE TABLE
COLOR SEE TABLE

INSULATOR, PP

SECONDARY LOCK (TPA): PBT OR NYLON 66

PACKAGING BY BAG

SECONDARY LOCK
(TPA)

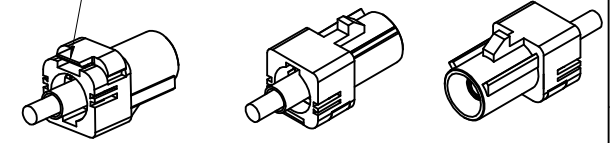

FAKRA
CONNECTOR
KEYING
CODE B SHOWN

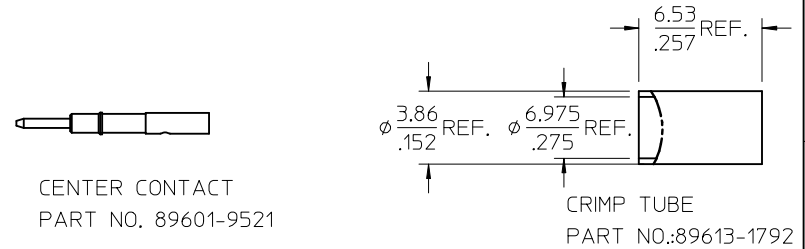
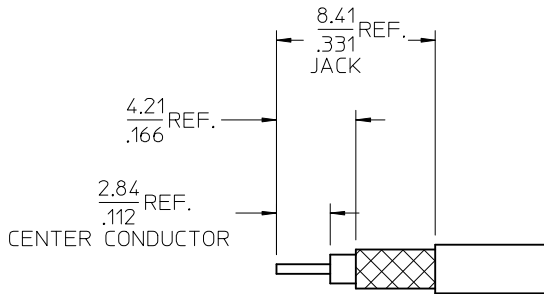
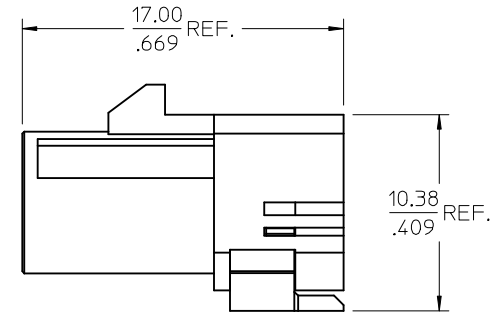
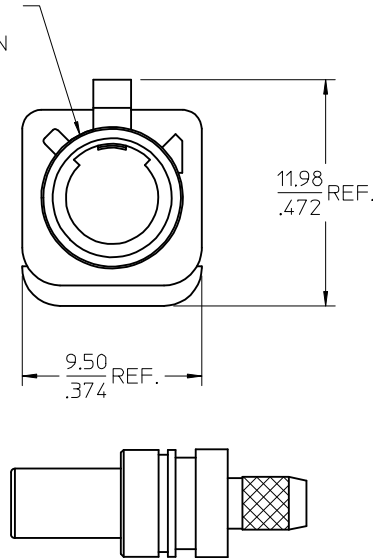

CENTER CONTACT
PART NO. 89601-9521

CRIMP TUBE
PART NO.:89613-1792

AS-73597-046	ASSYMBLY INSTRUCTIONS
PS-89675-331	PRODUCT SPECIFICATION
DIN 73594-1	INTERFACE SPECIFICATION
SPECIFICATION	DESCRIPTION

RTM PDR13031281 EC NO: URF2013-0510 DRWNLIN 2013/03/05 CHKD: A PPR:MHUANG 2013/07/10	DESCRIPTION	QUALITY SYMBOLS	GENERAL TOLERANCES (UNLESS SPECIFIED)	DIMENSION STYLE	SCALE	DESIGN UNITS	THIRD ANGLE PROJECTION
		▽=0 ▽=0 ▽=0	mm INCH	MM/IN	1:1	METRIC	
A	REV	4 PLACES ± --- ± ---	DRAWN BY DATE	TITLE			
		3 PLACES ± --- ± ---	EL IN 2013/03/05	FAKRA II JACK STR. FOR RG174/316 CABLE FAKRA-J			
A	REV	2 PLACES ± --- ± ---	CHECKED BY DATE	DOCUMENT NO. SD-73403-628			
		1 PLACE ± --- ± ---	KERRIE 2013/03/05				
A	REV	0 PLACE ± --- ± ---	APPROVED BY DATE	SHEET NO. 1 OF 3			
			MHUANG 2013/07/10				
		ANGULAR ± 2 °	SEE SHEET 2				
		DRAFT WHERE APPLICABLE MUST REMAIN WITHIN DIMENSIONS	THIS DRAWING CONTAINS INFORMATION THAT IS PROPRIETARY TO MOLEX INCORPORATED AND SHOULD NOT BE USED WITHOUT WRITTEN PERMISSION				

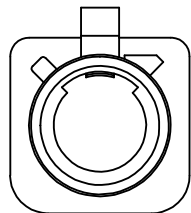

CODE-A

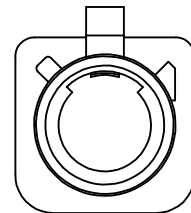

CODE-B

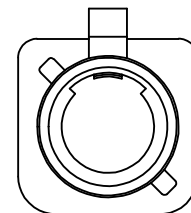

CODE-C

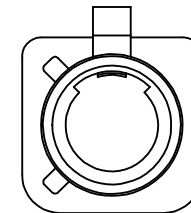

CODE-D

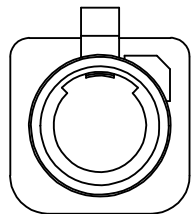

CODE-E

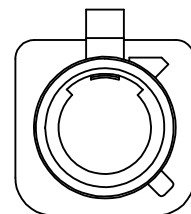

CODE-F

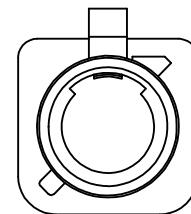

CODE-G

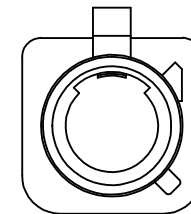

CODE-H

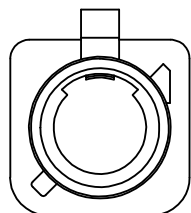

CODE-I

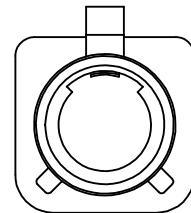

CODE-K

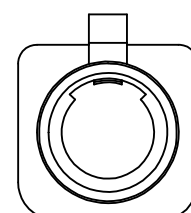

CODE-Z

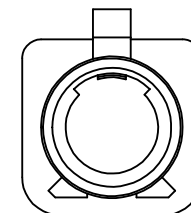

CODE-L

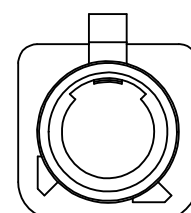

CODE-M

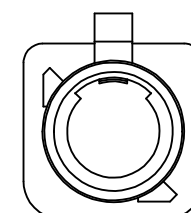

CODE-N

N	PASTEL GREEN	73403-6293
M	PASTEL ORANGE	73403-6292
L	CARMINE RED	73403-6291
Z	WATER BLUE	73403-6290
K	CURRY YELLOW	73403-6289
I	BEIGE	73403-6288
H	VIOLET	73403-6287
G	GRAY	73403-6286
F	BROWN	73403-6285
E	GREEN	73403-6284
D	BORDEAUXVIOLET	73403-6283
C	BLUE	73403-6282
B	NATURAL	73403-6281
A	BLACK	73403-6280
KEYING CODE	COLOR	PART NO.

SEE SHEET 1	QUALITY SYMBOLS
EC NO: URF2013-0510	
DRWNLIN 2013/03/05	
CHKD: APPR:MHUANG	
REV: 2013/07/10	

GENERAL TOLERANCES (UNLESS SPECIFIED)
4 PLACES ± --- ± ---
3 PLACES ± --- ± ---
2 PLACES ± --- ± ---
1 PLACE ± --- ± ---
0 PLACE ± --- ± ---
ANGULAR ± 2 °
DRAFT WHERE APPLICABLE MUST REMAIN WITHIN DIMENSIONS

DIMENSION STYLE	SCALE	DESIGN UNITS
MM/IN	1:1	METRIC
DRAWN BY	DATE	TITLE
EL IN	2013/03/05	FAKRA II JACK STR. FOR RG174/316 CABLE
CHECKED BY	DATE	FAKRA-J
KERRIE	2013/03/05	
APPROVED BY	DATE	
MHUANG	2013/07/10	

THIRD ANGLE PROJECTION	DOCUMENT NO.	SHEET NO.
	SD-73403-628	2 OF 3
THIS DRAWING CONTAINS INFORMATION THAT IS PROPRIETARY TO MOLEX INCORPORATED AND SHOULD NOT BE USED WITHOUT WRITTEN PERMISSION		

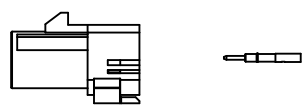

SHROUD WITH TPA x1
 CRIMP TUBE x1
 SMB SUB ASSY x1
 CENTER CONTACT x1

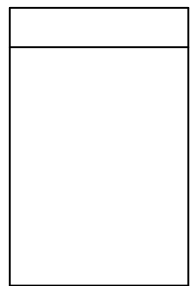

1 SET PER BAG
 BAG P/N: 89707-0317

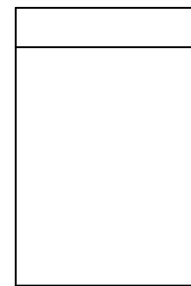

50 SET PER BAG
 BAG P/N: 89707-0174
 6" x 12"

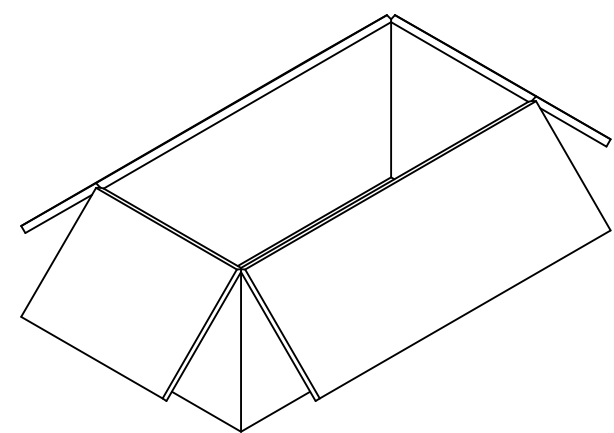

500 SET PER CARTON BOX
 P/N: 96707-0002
 367*176*188mm

SEE SHEET 1 EC NO: URF2013-0510 DRWNLIN 2013/03/05 CHKD: APPR:MHUANG 2013/07/10	QUALITY SYMBOLS	GENERAL TOLERANCES (UNLESS SPECIFIED)		DIMENSION STYLE		SCALE	DESIGN UNITS	THIRD ANGLE PROJECTION	
	▽=0	mm	INCH	MM/IN		1:3.33	METRIC		
	▽=0	4 PLACES ± ---	± ---	DRAWN BY	DATE	TITLE			
	▽=0	3 PLACES ± ---	± ---	EL IN	2013/03/05	FAKRA II JACK STR. FOR RG174/316 CABLE			
	2 PLACES ± ---	± ---	CHECKED BY		DATE	FAKRA-J			
	1 PLACE ± ---	± ---	KERRIE		2013/03/05	molex			
	0 PLACE ± ---	± ---	APPROVED BY		DATE				
			MHUANG		2013/07/10	MATERIAL NO.		DOCUMENT NO.	
			ANGULAR ± 2 °		SEE SHEET 2		SD-73403-628		SHEET NO.
			DRAFT WHERE APPLICABLE MUST REMAIN WITHIN DIMENSIONS		SIZE C		THIS DRAWING CONTAINS INFORMATION THAT IS PROPRIETARY TO MOLEX INCORPORATED AND SHOULD NOT BE USED WITHOUT WRITTEN PERMISSION		3 OF 3