

**Wire Wound Chip Common Mode Choke Coil**  
**DLW5ATN□□□MQ2□ Reference Specification**

**1. Scope**

This reference specification applies to Wire Wound Chip Common Mode Choke Coil DLW5AT\_MQ Series.

**2. Part Numbering**

(ex.) DL W 5A T N 111 M Q 2 L

- |                                     |                                |
|-------------------------------------|--------------------------------|
| (1) Chip Common Mode Choke Coil     | (6) Impedance (Typ. at 100MHz) |
| (2) Structure (W : Winding Type)    | (7) Circuit                    |
| (3) Dimension (L × W)               | (8) Features                   |
| (4) One Circuit and Low Height Type | (9) Number of Line             |
| (5) Category                        | (10) Packaging Code            |
- L : Taping (φ 180mm/reel)  
 K : Taping (φ 330mm/reel)  
 B : Bulk

**3. Rating**

| Customer Part Number | MURATA Part Number | Impedance at 10MHz, Under Standard Testing Conditions (min. Ω) | Impedance at 100MHz, Under Standard Testing Conditions (Ω Typ.) | Rated Voltage V(DC) | Withstanding Voltage V(DC) | *Rated Current (A) | DC Resistance (Rdc) (Ω max.) | Insulation Resistance (MΩ min.) |
|----------------------|--------------------|--|---|---------------------|----------------------------|--------------------|------------------------------|---------------------------------|
|                      | DLW5ATN500MQ2L     | 4.6  | 50  | 100                 | 250                        | 6.0                | 0.013                        | 10                              |
|                      | DLW5ATN500MQ2K     |  |   |                     |                            |                    |                              |                                 |
|                      | DLW5ATN500MQ2B     |  |   |                     |                            |                    |                              |                                 |
|                      | DLW5ATN151MQ2L     | 11   | 150   |                     |                            |                    |                              |                                 |
|                      | DLW5ATN151MQ2K     |  |   |                     |                            |                    |                              |                                 |
|                      | DLW5ATN151MQ2B     |  |   |                     |                            |                    |                              |                                 |
|                      | DLW5ATN331MQ2L     | 20   | 330   |                     |                            |                    |                              |                                 |
|                      | DLW5ATN331MQ2K     |  |   |                     |                            |                    |                              |                                 |
|                      | DLW5ATN331MQ2B     |  |   |                     |                            |                    |                              |                                 |
|                      | DLW5ATN501MQ2L     | 35   | 500   |                     |                            |                    |                              |                                 |
|                      | DLW5ATN501MQ2K     |  |   |                     |                            |                    |                              |                                 |
|                      | DLW5ATN501MQ2B     |  |   |                     |                            |                    |                              |                                 |
|                      | DLW5ATN112MQ2L     | 50   | 1100  |                     |                            |                    |                              |                                 |
|                      | DLW5ATN112MQ2K     |  |   |                     |                            |                    |                              |                                 |
|                      | DLW5ATN112MQ2B     |  |   |                     |                            |                    |                              |                                 |

· Operating Temperature : - 40 °C to + 105 °C      · Storage Temperature : - 40 °C to + 105 °C

**Derating**

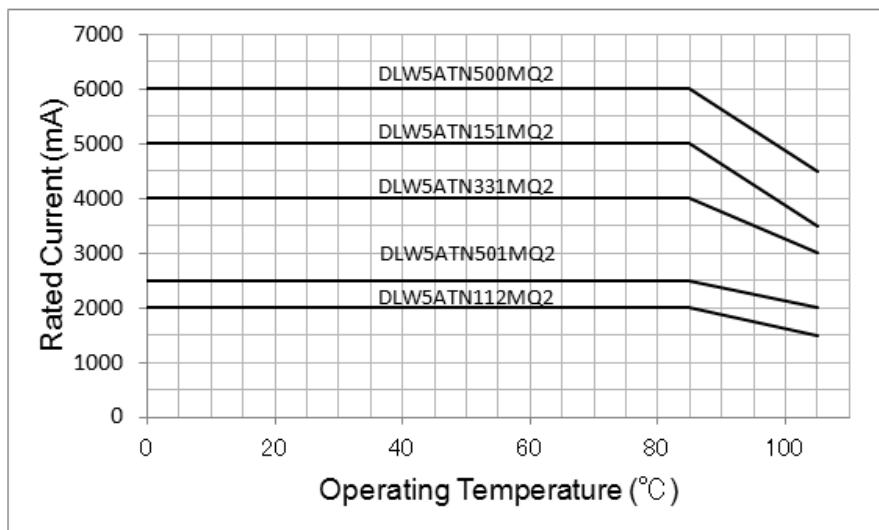

### 4. Standard Testing Conditions

< Unless otherwise specified >

Temperature : Ordinary Temp. 15 °C to 35 °C  
 Humidity : Ordinary Humidity 25 %(RH) to 85 %(RH)

< In case of doubt >

Temperature : 20 °C ± 2 °C  
 Humidity : 60 %(RH) to 70 %(RH)  
 Atmospheric pressure : 86 kPa to 106 kPa

### 5. Style and Dimensions

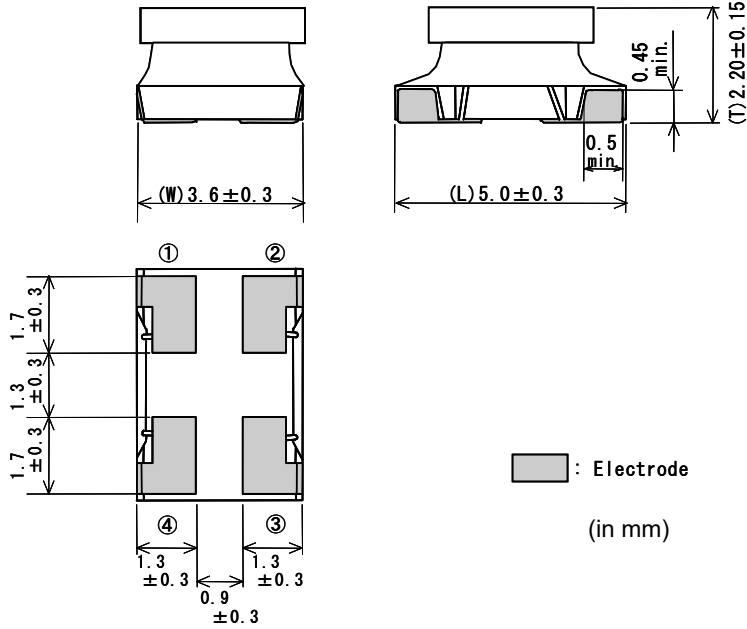

#### Equivalent Circuits

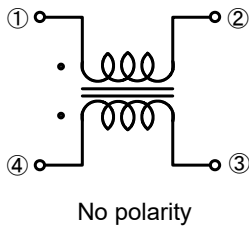

#### Unit Mass (Typical value)

0.140g

### 6. Marking

No marking.

### 7. Electrical Performance

| No. | Item                         | Specifications                 | Test Method   |
|-----|------------------------------|--------------------------------|---|
| 7.1 | Impedance ( Z ) (at 10MHz)   | Meet item 3.                   | Measuring Equipment : KEYSIGHT 4191A or the equivalents.<br>Measuring Frequency : 10MHz (ref. Item 10.)                                       |
| 7.2 | Insulation Resistance (I.R.) |                                | Measuring Equipment : R8340A or the equivalents.<br>Test Voltage : 100V<br>Time : within 60 s (ref. Item 10.)                                 |
| 7.3 | DC Resistance (Rdc)          |                                | Measuring Current : 100 mA max. (ref. Item 10.)<br>(In case of doubt in the above mentioned standard condition,measure by 4 terminal method.) |
| 7.4 | Withstanding Voltage         | Products shall not be damaged. | Voltage : 250 V(DC)<br>Time : 60 s<br>Charge Current : 1 mA max. (ref. Item 10.)  |

## 8. Mechanical Performance

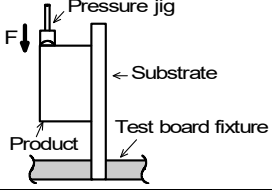
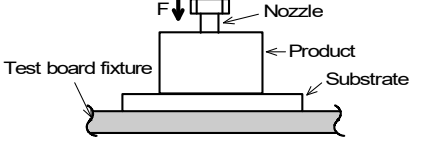
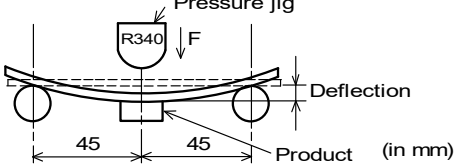
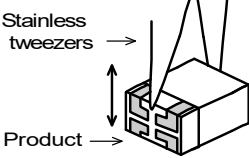
| No.                         | Item                               | Specifications  | Test Method   |             |                             |              |      |           |                      |             |   |
|-----------------------------|------------------------------------|---|---|-------------|-----------------------------|--------------|------|-----------|----------------------|-------------|---|
| 8.1                         | Appearance and Dimensions          | Meet item 5.  | Visual Inspection and measured with Slide Calipers.   |             |                             |              |      |           |                      |             |   |
| 8.2                         | Bonding Strength and Core Strength | No evidence of chipping, breakage. No evidence of coming off glass-epoxy substrate.   | Applying Force (F) : 10N<br>Applying Time : 5±1s<br>   |             |                             |              |      |           |                      |             |   |
| 8.3                         | Body strength                      | No evidence of chipping, breakage.  | Applying Force (F) : 10N<br>Applying Time : 5±1s<br>   |             |                             |              |      |           |                      |             |   |
| 8.4                         | Bending Strength                   | Meet Table 1.<br><u>Table 1</u> <table border="1" style="margin-left: 20px; border-collapse: collapse;"> <tr> <td style="padding: 2px;">Appearance</td> <td style="padding: 2px;">No damaged.</td> </tr> <tr> <td style="padding: 2px;">Impedance change (at 10MHz)</td> <td style="padding: 2px;">within ± 20%</td> </tr> <tr> <td style="padding: 2px;">I.R.</td> <td style="padding: 2px;">10MΩ min.</td> </tr> <tr> <td style="padding: 2px;">Withstanding Voltage</td> <td style="padding: 2px;">No damaged.</td> </tr> </table> | Appearance  | No damaged. | Impedance change (at 10MHz) | within ± 20% | I.R. | 10MΩ min. | Withstanding Voltage | No damaged. | Substrate : Glass-epoxy (t=1.6mm)<br>Deflection : 2mm<br>Keeping Time : 30 s<br>Speed of Applying Force : 0.5 mm/s<br> |
| Appearance                  | No damaged.                        |   |   |             |                             |              |      |           |                      |             |   |
| Impedance change (at 10MHz) | within ± 20%                       |   |   |             |                             |              |      |           |                      |             |   |
| I.R.                        | 10MΩ min.                          |   |   |             |                             |              |      |           |                      |             |   |
| Withstanding Voltage        | No damaged.                        |   |   |             |                             |              |      |           |                      |             |   |
| 8.5                         | Vibration                          |   | Products shall be soldered on the substrate.<br>Oscillation Frequency : 10 to 55 to 10Hz for 1 min.<br>Total Amplitude : 1.5mm<br>Testing Time : A period of 2 hours in each of 3 mutually perpendicular directions (Total 6 hours).  |             |                             |              |      |           |                      |             |   |
| 8.6                         | Drop                               |   | Products shall be dropped concrete or steel board.<br>Method : free fall<br>Height : 1m<br>The Number of Times : 10 Times   |             |                             |              |      |           |                      |             |   |
| 8.7                         | Solderability                      | The electrodes shall be at least 90% covered with new solder coating.   | Flux : Ethanol solution of rosin, 25(wt)%<br>Pre heating : 150 ± 10°C, 1 minute.<br>Solder : Sn-3.0Ag-0.5Cu<br>Solder Temperature : 245±5°C<br>Immersion Time : 4±1s<br>Immersion and Immersion rates : 25mm/s<br> |             |                             |              |      |           |                      |             |   |
| 8.8                         | Resistance to Soldering heat       | Meet Table 1.   | Flux : Ethanol solution of rosin, 25(wt)%<br>Pre heating : 150 ± 10°C, 1 minute.<br>Solder : Sn-3.0Ag-0.5Cu<br>Solder Temperature : 270 ± 5°C<br>Immersion Time : 5±1s<br>Immersion and Immersion rates : 25mm/s<br>Then measured after exposure in the room condition for 4 to 48 hours.               |             |                             |              |      |           |                      |             |   |

**9. Environmental Performance** (Product shall be soldered on the glass-epoxy substrate (t=1.6mm).)

| No. | Item              | Specifications | Test Method  |
|-----|-------------------|----------------|--|
| 9.1 | Temperature Cycle | Meet Table 1.  | 1 cycle<br>1 step : -40 °C (+0, -3)°C / 30min (+ 3,- 0) min<br>2 step : Ordinary temp. / 3 min max.<br>3 step : +105 °C (+3, -0)°C / 30min (+ 3,- 0) min<br>4 step : Ordinary temp. / 3 min max.<br>Total of 100 cycles<br>Then measured after exposure in the room condition for 4 to 48 hours. |
| 9.2 | Humidity          |                | Temperature : 40 ± 2 °C<br>Humidity : 90 to 95 %(RH)<br>Time : 1000 h (+48 h , -0 h)<br>Then measured after exposure in the room condition for 4 to 48 hours.  |
| 9.3 | Humidity Load     |                | Temperature : 40 ± 2 °C<br>Humidity : 90 to 95 %(RH)<br>Test Voltage : Rated Voltage<br>Time : 1000 h (+48 h , -0 h)<br>Then measured after exposure in the room condition for 4 to 48 hours. (ref. Item 10.)  |
| 9.4 | Heat life         |                | Temperature : 105 ± 2 °C<br>Test Voltage : 2times for Rated Voltage<br>Time : 1000 h (+48 h , -0 h)<br>Then measured after exposure in the room condition for 4 to 48 hours. (ref. Item 10.)   |
| 9.5 | Cold Resistance   |                | Temperature : - 40 ± 2 °C<br>Time : 1000 h (+48 h , -0 h)<br>Then measured after exposure in the room condition for 4 to 48 hours. (ref. Item 10.)   |

**10. Terminal to be Tested** When measuring and supplying the voltage, the following terminal is applied.

| No.  | Item   | Terminal to be Tested |
|------|--|-----------------------|
| 10.1 | Impedance ( Z )<br>(Measurement Terminal)              |                       |
| 10.2 | DC Resistance (Rdc)<br>(Measurement Terminal)          |                       |
| 10.3 | Insulation Resistance (I.R.)<br>(Measurement Terminal) |                       |
| 10.4 | Withstanding Voltage<br>(Measurement Terminal)         |                       |
| 10.5 | Humidity Load (Supply Terminal)                        |                       |
| 10.6 | Heat Life (Supply Terminal)                            |                       |

## 11. Impedance Frequency Characteristics (Typical)

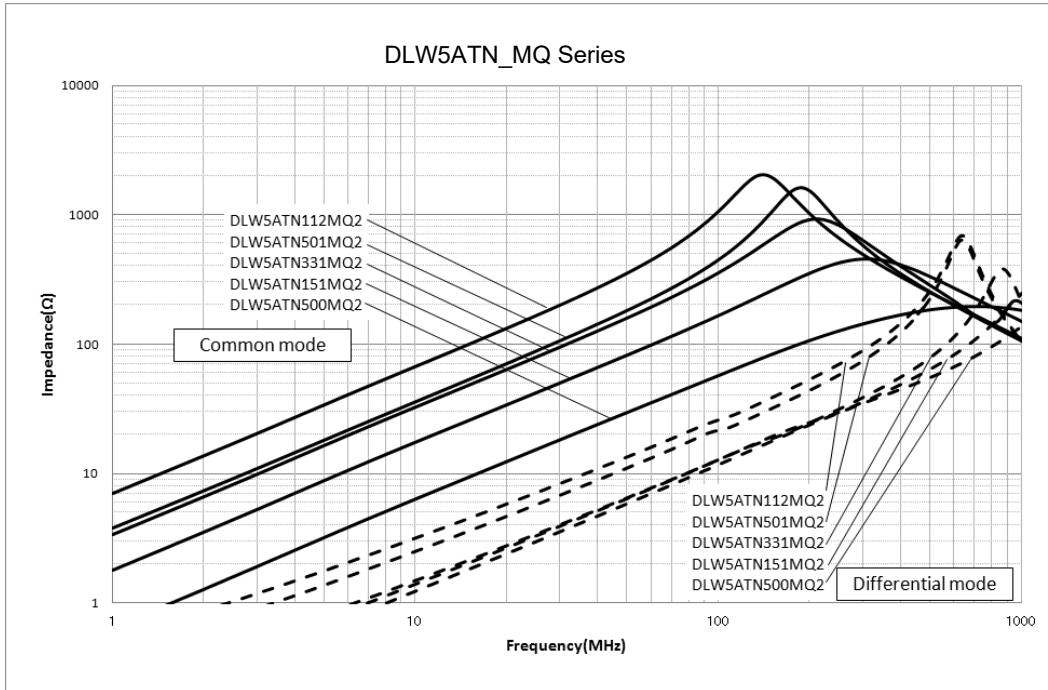

## 12. Specification of Packaging

### 12.1 Appearance and Dimensions

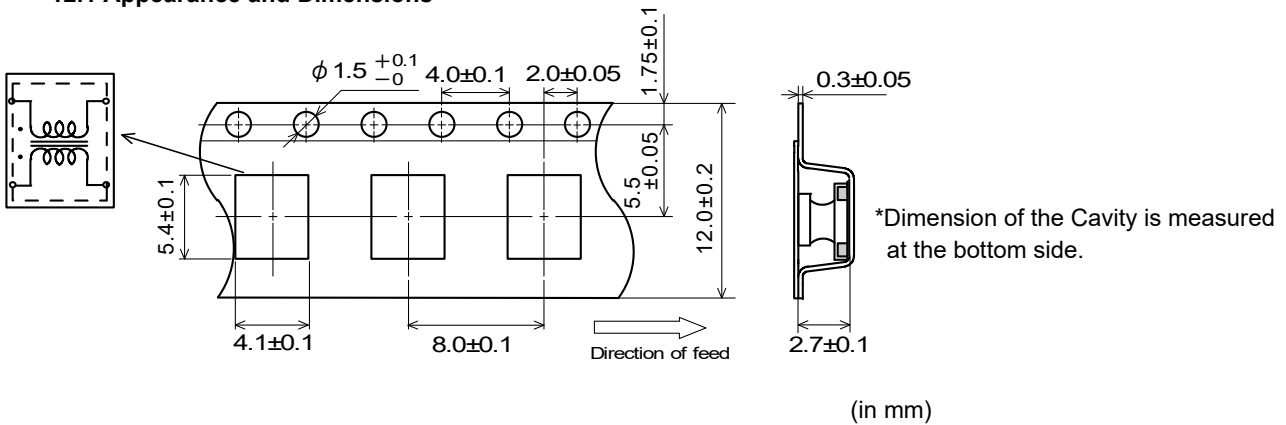

### 12.2 Specification of Taping

- (1) Packing quantity (Standard quantity)  $\phi$  180 mm reel : 700 pcs. / reel  $\phi$  330 mm reel : 2500 pcs. / reel
- (2) Packing Method  
Products shall be packaged in each embossed cavity of plastic tape and sealed with cover tape.
- (3) Sprocket Hole  
The sprocket holes are to the right as the tape is pulled toward the user.
- (4) Spliced point  
The cover tape have no spliced point.
- (5) Missing components number  
Missing components number within 0.025% of the number per reel or 1 pc., whichever is greater, and are not continuous. The specified quantity per reel is kept.

### 12.3 Pull Strength of Plastic Tape

|              |           |
|--------------|-----------|
| Plastic Tape | 5 N min.  |
| Cover Tape   | 10 N min. |

### 12.4 Peeling off force of Cover Tape

0.2N to 0.7N (minimum value is typical.)  
Speed of Peeling off : 300 mm / min

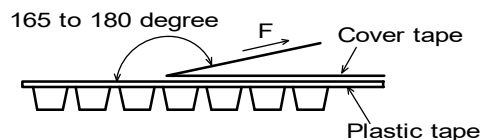

### 12.5 Dimensions of Leader-tape, Trailer and Reel

There shall be leader-tape (cover tape only and empty tape) and trailer-tape (empty tape) as follows.

« Packaging Code : L (φ 180mm reel) »

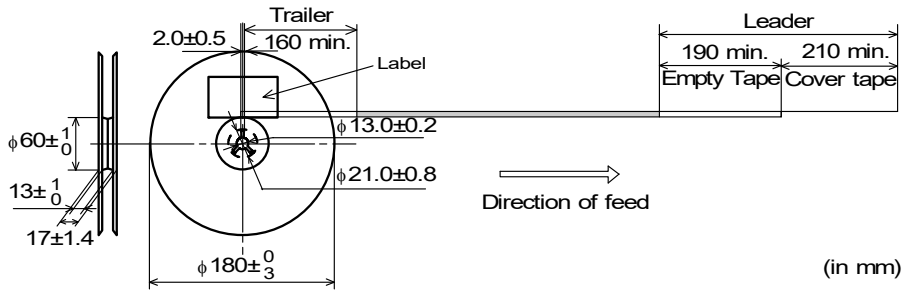

« Packaging Code : K (φ 330mm reel) »

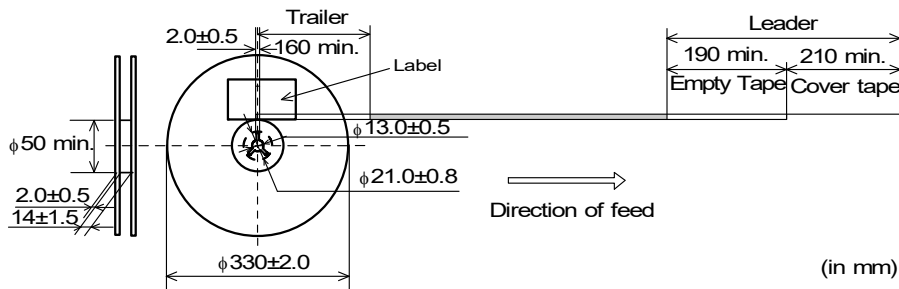

### 12.6 Marking for reel

Customer part number, MURATA part number, Inspection number(\*1), RoHS marking(\*2), Quantity, etc

\*1) « Expression of Inspection No. »

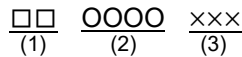

(1) Factory Code

(2) Date

First digit : Year / Last digit of year

Second digit : Month / Jan. to Sep. → 1 to 9, Oct. to Dec. → O,N,D

Third, Fourth digit : Day

(3) Serial No.

\*2) « Expression of RoHS marking »

ROHS - Y (Δ)

(1) (2)

(1) RoHS regulation conformity parts.

(2) MURATA classification number

### 12.7 Marking for Outside package

Customer name Purchasing Order Number, Customer Part Number, MURATA part number, RoHS marking(\*2), Quantity, etc

### 12.8 Specification of Outer Case

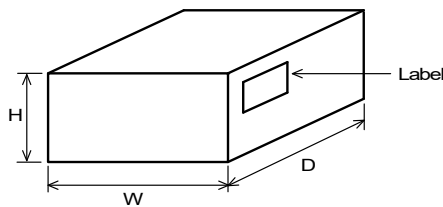

| Reel    | Outer Case Dimensions (mm) |     |    | Standard Reel Quantity in Outer Case (Reel) |
|---------|----------------------------|-----|----|---|
|         | W                          | D   | H  |   |
| φ 180mm | 186                        | 186 | 93 | 4   |
| φ 330mm | 340                        | 340 | 85 | 4   |

\* Above Outer Case size is typical. It depends on a quantity of an order.

### 13. Caution

#### 13.1 Mounting Direction

Mount products in right direction.

Wrong direction which is 90 ° rotated from right direction cause not open or short circuit but also flames or other serious trouble.

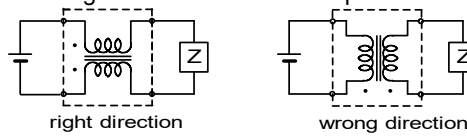

#### 13.2 Limitation of Applications

Please contact us before using our products for the applications listed below which require especially high reliability for the prevention of defects which might directly cause damage to the third party's life, body or property.

- (1) Aircraft equipment    (2) Aerospace equipment    (3) Undersea equipment    (4) Power plant control equipment
- (5) Medical equipment    (6) Transportation equipment (automobiles, trains, ships, etc.)    (7) Traffic signal equipment
- (8) Disaster prevention / crime prevention equipment    (9) Data-processing equipment
- (10) Applications of similar complexity or with reliability requirements comparable to the applications listed in the above

#### 13.3 Corrosive gas

Please refrain from use since contact with environments with corrosive gases (sulfur gas [hydrogen sulfide, sulfur dioxide, etc.], chlorine, ammonia, etc.) or oils (cutting oil, silicone oil, etc.) that have come into contact with the previously stated corrosive gas environment will result in deterioration of product quality or an open from deterioration due to corrosion of product electrode, etc. We will not bear any responsibility for use under these environments.

### 14. Notice

This product is designed for solder mounting.

Please consult us in advance for applying other mounting method such as conductive adhesive.

#### 14.1 Flux and Solder

|        |  |
|--------|--|
| Flux   | Use rosin-based flux, (with converting chlorine content 0.06 to 0.1(wt)% ), but not highly acidic flux (with Halogen content exceeding 0.2(wt)% conversion to chlorine).<br>Do not use water-soluble flux. |
| Solder | Use Sn-3.0Ag-0.5Cu solder  |

#### 14.2 Assembling

Products can be applied to reflow and flow soldering.

< Thermal Shock >

Pre-heating should be in such a way that the temperature difference between solder and ceramic surface is limited to 100°C max. Also cooling into solvent after soldering should be in such a way that the temperature difference is limited to 100°C max.

Not enough preheating may cause deterioration in insulation resistance and / or crack or ceramic body.

#### 14.3 Cleaning Conditions

Products shall be cleaned on the following conditions.

- (1) Cleaning temperature shall be limited to 60°C max. (40°C max. for IPA.)
- (2) Ultrasonic cleaning shall comply with the following conditions, avoiding the resonance phenomenon at the mounted products and P.C.B.

Power: 20W/ l max.    Frequency: 28kHz to 40kHz    Time: 5 min max.

- (3) Cleaner

1. Cleaner

· Isopropyl alcohol (IPA)

2. Aqueous agent

· PINE ALPHA ST-100S

- (4) There shall be no residual flux and residual cleaner after cleaning.

In the case of using aqueous agent, products shall be dried completely after rinse with de-ionized water in order to remove the cleaner.

- (5) Other cleaning

Please contact us.

### 14.4 Resin coating

The impedance value may change due to high cure-stress of resin to be used for coating/molding products. An open circuit issue may occur by mechanical stress caused by the resin, amount/cured shape of resin, or operating condition etc. Some resin contains some impurities or chloride possible to generate chlorine by hydrolysis under some operating condition may cause corrosion of wire of coil, leading to open circuit. So, please pay your careful attention when you select resin in case of coating/molding the products with the resin. Prior to use the coating resin, please make sure no reliability issue is observed by evaluating products mounted on your board.

### 14.5 Attention regarding P.C.B. bending

The following shall be considered when designing and laying out P.C.B.'s.

- (1) P.C.B. shall be designed so that products are not subject to the mechanical stress due to warping the board.  
[Products direction]

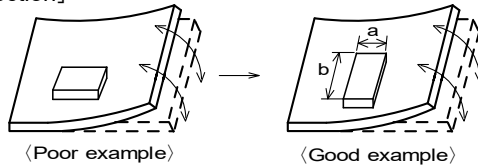

Products shall be location the sideways direction (Length:a<b) to the mechanical stress.

- (2) Components location on P.C.B. separation.

It is effective to implement the following measures, to reduce stress in separating the board.

It is best to implement all of the following three measures; however, implement as many measures as possible to reduce stress.

| Contents of Measures   | Stress Level |
|--|--------------|
| (1) Turn the mounting direction of the component parallel to the board separation surface. | A > D *1     |
| (2) Add slits in the board separation part.  | A > B        |
| (3) Keep the mounting position of the component away from the board separation surface.    | A > C        |

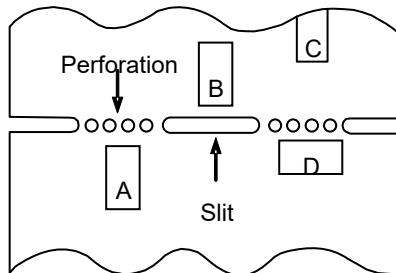

\*1 A > D is valid when stress is added vertically to the perforation as with Hand Separation. If a Cutting Disc is used, stress will be diagonal to the PCB, therefore A > D is invalid.

- (3) Mounting Components Near Screw Holes

When a component is mounted near a screw hole, it may be affected by the board deflection that occurs during the tightening of the screw. Mount the component in a position as far away from the screw holes as possible.

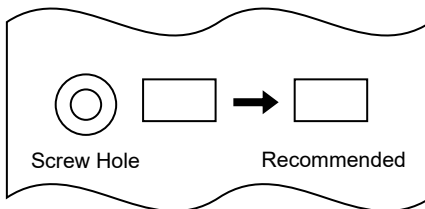



### 14.6 Attention Regarding P.C.B. Design

< The Arrangement of Products >

- P.C.B. shall be designed so that products are far from the portion of perforation.
- The portion of perforation shall be designed as narrow as possible, and shall be designed so as not to be applied the stress in the case of P.C.B. separation.

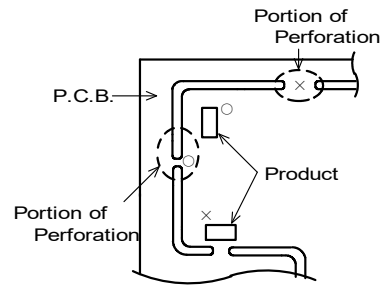

- Products shall not be arranged on the line of a series of holes when there are big holes in P.C.B.  
(Because the stress concentrate on the line of holes.)

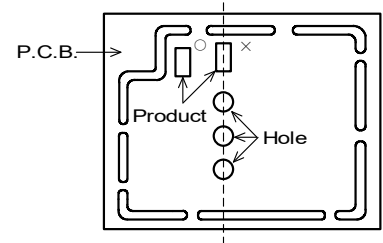

< Products Placing >

- Support pins shall be set under P.C.B. to prevent causing a warp to P.C.B. during placing the products on the other side of P.C.B..

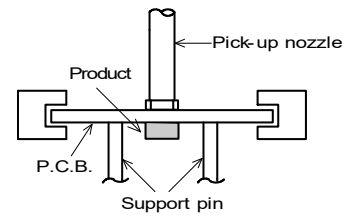

< P.C.B. Separation >

- P.C.B. shall not be separated with hand.  
P.C.B. shall be separated with the fixture so as not to cause P.C.B. bending.

### 14.7 Standard Land Dimensions

<Reflow>

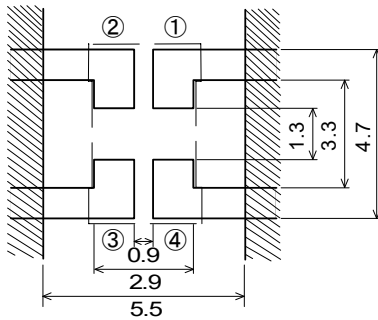

\*①②③④ indicates terminal number.

- Resist
- Copper foil pattern
- No pattern

(in mm)

<Flow>

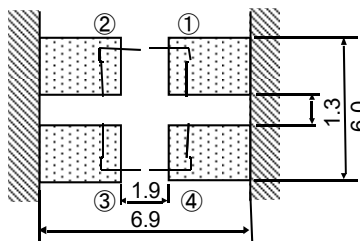

(in mm)

### 14.8 Solder paste printing for reflow

- Standard thickness of solder paste should be 150 to 200 $\mu$ m. Solderability is subject to reflow condition and thermal conductivity. Please make sure that your product has been evaluated in view of your specifications with our product being mounted to your product.
- Use the solder paste printing pattern of the right pattern.
- For the resist and copper foil pattern, use standard land dimensions.
- Use the Solder Sn-3.0Ag-0.5Cu for pattern printing.

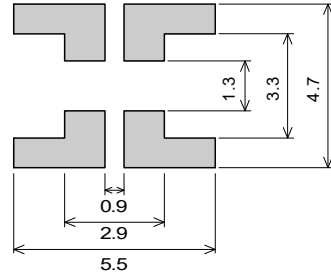

(in mm)

### (2) Soldering Conditions

Standard soldering profile and the limit soldering profile is as follows.

The excessive soldering conditions may cause leaching of the electrode and/or resulting in the deterioration of product quality.

#### <Reflow>

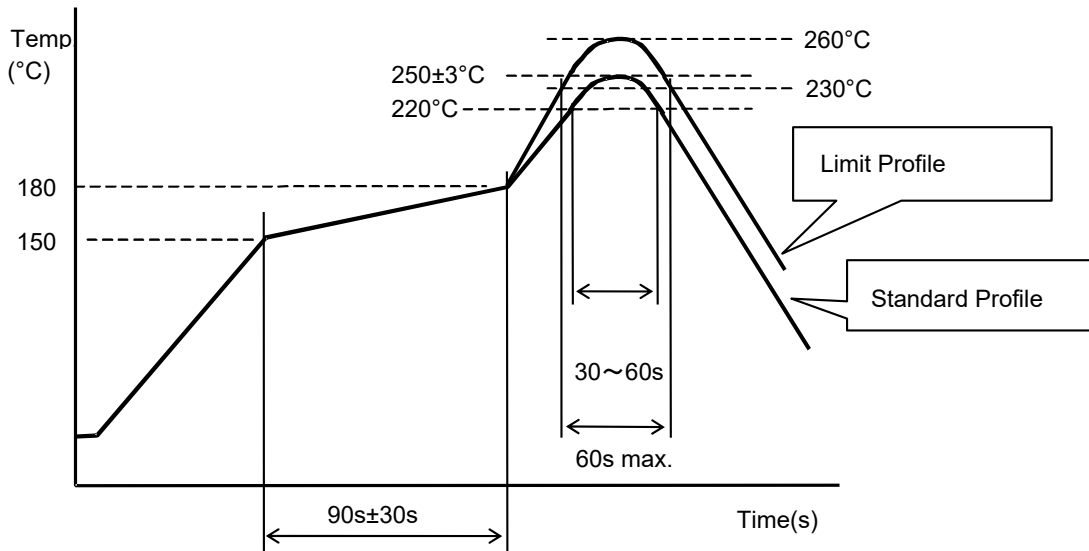

|                  | Standard Profile    | Limit Profile        |
|------------------|---------------------|----------------------|
| Pre-heating      | 150~180°C、90s±30s   |                      |
| Heating          | above 220°C、30s~60s | above 230°C、60s max. |
| Peak temperature | 250±3°C             | 260°C, 10s           |
| Cycle of reflow  | 2 times             | 2 times              |

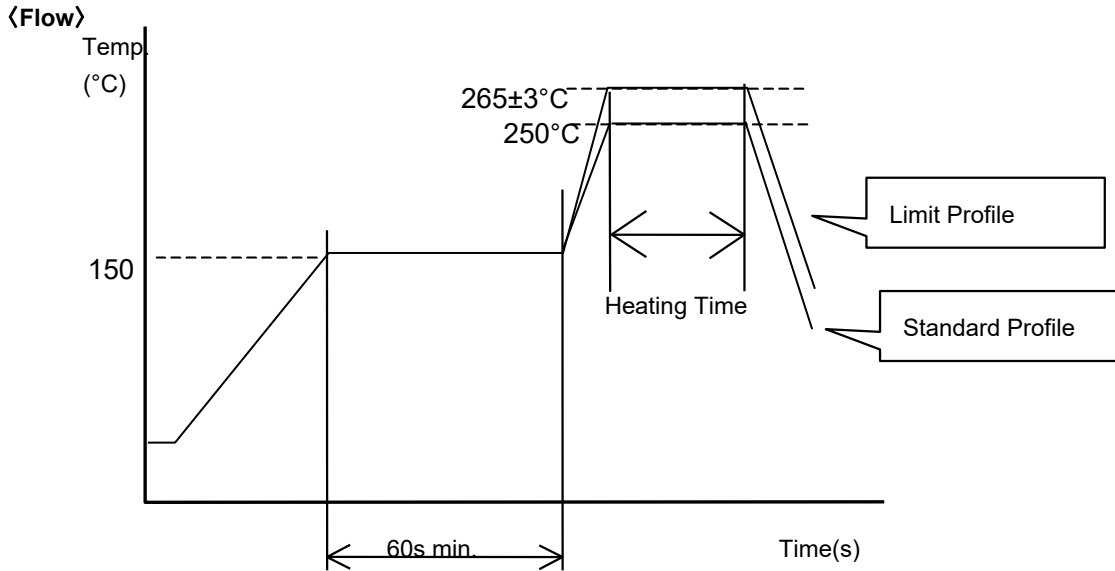

|               | Standard Profile | Limit Profile    |
|---------------|------------------|------------------|
| Pre-heating   | 150°C, 60s min.  |                  |
| Heating       | 250°C, 4~6s      | 265±3°C, 5s max. |
| Cycle of flow | 2 times          |                  |

**(3)Printing of Adhesive (Flow Soldering)**

Adhesive amount should be around 0.5mg /a chip.

- To get enough bonding strength
- To avoid spreading of adhesive onto a land. Because soldering failure may be caused by adhesive on the land.

The adhesive position is as follows.

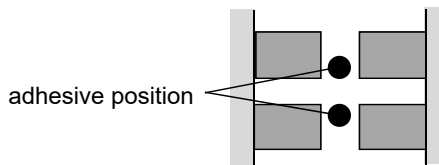

**14.9 Reworking with Soldering iron**

The following conditions must be strictly followed when using a soldering iron after being mounted by reflow soldering.

- Pre-heating: 150°C, 1 min
- Tip temperature: 350°C max.
- Soldering time : 3(+1,-0) seconds.
- Soldering iron output: 30W max.
- Tip diameter:φ3mm max.
- Times : 2times max.

Notes: Do not touch the products directly with the soldering iron.

**14.10 Handling of a substrate**

After mounting products on a substrate, do not apply any stress to the product caused by bending or twisting to the substrate when cropping the substrate, inserting and removing a connector from the substrate or tightening screw to the substrate.

Excessive mechanical stress may cause cracking in the product.

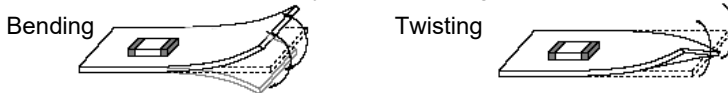

**14.11 Brushing of neighborhood of products**

When you clean the neighborhood of products such as connector pins, bristles of cleaning brush shall not be touched to the winding portion to prevent the breaking of wire.

**14.12 Operating Environment**

Do not use this product under the following environmental conditions, on deterioration of the performance, such as insulation resistance may result from the use.

- (1) in corrosive gases (acidic gases,alkaline gases,chlorine,sulfur gases,organic gases and etc.)
- (2) in the atmosphere where liquid such as organic solvent,may splash on the products.

## 14.13 Storage condition

### (1) Storage period

Use the products within 12 months after delivered.

Solderability should be checked if this period is exceeded.

### (2) Storage environment conditions

· Products should be stored in the warehouse on the following conditions.

Temperature : -10 °C to +40 °C

Humidity : 15 % to 85% relative humidity No rapid change on temperature and humidity.

· Products should not be stored in corrosive gases, such as sulfurous, acid gases, alkaline gases, to prevent the following deterioration.

Poor solderability due to the oxidized electrode.

· Products should be stored on the palette for the prevention of the influence from humidity, dust and so on.

· Products should be stored in the warehouse without heat shock, vibration, direct sunlight and so on.

· Avoid storing the product by itself bare (i.e.exposed directly to air).

### (3) Delivery

Care should be taken when transporting or handling product to avoid excessive vibration or mechanical shock.

## 15. Note

(1) Please make sure that your product has been evaluated in view of your specifications with our product being mounted to your product.

(2) You are requested not to use our product deviating from the reference specifications.

(3) The contents of this reference specification are subject to change without advance notice. Please approve our product specifications or transact the approval sheet for product specifications before ordering.