

File Number 1854

**CD54/74HC 4046A**  
**CD54/74HCT 4046A**

Advance Information/  
Preliminary Data

HARRIS SEMICONDUCTOR

27E D 4302271 0017900 5 HAS

**High-Speed CMOS Logic**

T-50-17-00

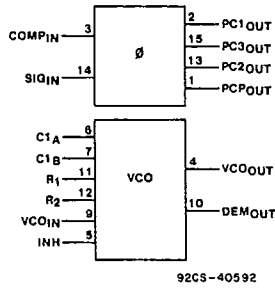

FUNCTIONAL DIAGRAM

**Phase-Locked-Loop with VCO**

**Features:**

- Operating frequency range of up to 18 MHz (typ.) at  $V_{CC} = 5 V$
- Choice of three phase comparators: **EXCLUSIVE-OR:** edge-triggered JK flip-flop; **edge-triggered RS flip-flop**
- Excellent VCO frequency linearity
- VCO-inhibit control for ON/OFF keying and for low standby power consumption
- Minimal frequency drift

- Operating power supply voltage range: VCO section 3 V to 6 V; digital section 2 V to 6 V

**Applications:**

- FM modulation and demodulation
- Frequency synthesis and multiplication
- Frequency discrimination
- Tone decoding
- Data synchronization and conditioning
- Voltage-to-frequency conversion
- Motor-speed control

The RCA CD54/74 HC/HCT4046A are high-speed Si-gate CMOS devices that are pin compatible with the CD4046B of the "4000B" series. They are specified in compliance with JEDEC standard no. 7.

The HC/HCT4046A are phase-locked-loop circuits that contain a linear voltage-controlled oscillator (VCO) and three different phase comparators (PC1, PC2 and PC3). A signal input and a comparator input are common to each comparator.

The signal input can be directly coupled to large voltage signals, or indirectly coupled (with a series capacitor) to small voltage signals. A self-bias input circuit keeps small voltage signals within the linear region of the input amplifiers. With a passive low-pass filter, the 4046A forms a second-order loop PLL. The excellent VCO linearity is achieved by the use of linear op-amp techniques.

The CD54HC4046A and CD54HCT4046A are supplied in 16-lead ceramic dual-in-line packages (F suffix). The CD74HC4046A and CD74HCT4046A are supplied in 16-lead plastic dual-in-line packages (E suffix), and in 16-lead surface mount plastic dual-in-line packages (M suffix). The CD54/74HC/HCT4046A are also supplied in chip form (H suffix).

**Family Features:**

- Fanout (Over Temperature Range); Standard Outputs - 10 LSTTL Loads; Bus Driver Outputs - 15 LSTTL Loads
- Wide Operating Temperature Range: CD74HC/HCT/HCU: -40 to +85°C
- Balanced Propagation Delay and Transition Times
- Significant Power Reduction Compared to LSTTL Logic ICs
- Alternate Source is Phillips/Signetics
- CD54HC/CD74HC Types: 2 to 6 V Operation; High Noise Immunity:  $N_{IL} = 30\%$ ,  $N_{IH} = 30\%$  of  $V_{CC}$  @  $V_{CC} = 5 V$
- CD54HCT/CD74HCT Types: 4.5 to 5.5 V Operation; Direct LSTTL Input Logic Compatibility:  $V_{IL} = 0.8 V$  Max.,  $V_{IH} = 2 V$  Min.; CMOS Input Compatibility:  $I_i \leq 1 \mu A$  @  $V_{OL}$ ,  $V_{OH}$

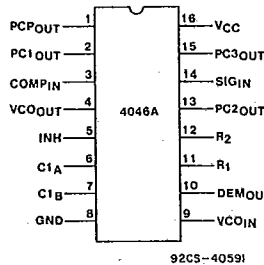

TERMINAL ASSIGNMENT

**CD54/74HC4046A**  
**CD54/74HCT4046A**

HARRIS SEMICONDUCTOR 27E D 4302271 0017901 7 HAS

**MAXIMUM RATINGS, Absolute-Maximum Values**

DC SUPPLY-VOLTAGE ( $V_{CC}$ ):  
 (Voltages referenced to ground) ..... -0.5 to +7 V

DC INPUT DIODE CURRENT,  $I_{IK}$  (for  $V_I < -0.5$  V or  $V_I > V_{CC} + 0.5$  V) .....  $\pm 20$  mA

DC OUTPUT DIODE CURRENT,  $I_{OK}$  (for  $V_O < -0.5$  V or  $V_O > V_{CC} + 0.5$  V) .....  $\pm 20$  mA

DC DRAIN CURRENT, PER OUTPUT ( $I_O$ ) (for  $-0.5$  V  $< V_O < V_{CC} + 0.5$  V) .....  $\pm 25$  mA

DC  $V_{CC}$  OR GROUND CURRENT ( $I_{CC}$ ): .....  $\pm 50$  mA

POWER DISSIPATION PER PACKAGE ( $P_D$ ):

For  $T_A = -40$  to  $+60^\circ\text{C}$  (PACKAGE TYPE E) ..... 500 mW

For  $T_A = +60$  to  $+85^\circ\text{C}$  (PACKAGE TYPE E) ..... Derate Linearly at 8 mW/ $^\circ\text{C}$  to 300 mW

For  $T_A = -55$  to  $+100^\circ\text{C}$  (PACKAGE TYPE F, H) ..... 500 mW

For  $T_A = +100$  to  $+125^\circ\text{C}$  (PACKAGE TYPE F, H) ..... Derate Linearly at 8 mW/ $^\circ\text{C}$  to 300 mW

For  $T_A = -40$  to  $+70^\circ\text{C}$  (PACKAGE TYPE M) ..... 400 mW

For  $T_A = +70$  to  $+125^\circ\text{C}$  (PACKAGE TYPE M) ..... Derate Linearly at 6 mW/ $^\circ\text{C}$  to 70 mW

OPERATING-TEMPERATURE RANGE ( $T_A$ ):

PACKAGE TYPE F, H .....  $-55$  to  $+125^\circ\text{C}$

PACKAGE TYPE E, M .....  $-40$  to  $+85^\circ\text{C}$

STORAGE TEMPERATURE ( $T_{STG}$ ) .....  $-65$  to  $+150^\circ\text{C}$

LEAD TEMPERATURE (DURING SOLDERING):

At distance  $1/16 \pm 1/32$  in. ( $1.59 \pm 0.79$  mm) from case for 10 s max. ....  $+265^\circ\text{C}$

Unit inserted into a PC Board (min. thickness  $1/16$  in.,  $1.59$  mm) with solder contacting lead tips only .....  $+300^\circ\text{C}$

**RECOMMENDED OPERATING CONDITIONS:**

For maximum reliability, nominal operating conditions should be selected so that operation is always with the following ranges:

CHARACTERISTIC	LIMITS		UNITS
	MIN.	MAX.	
Supply-Voltage Range (for $T_A =$ Full Package-Temperature Range) $V_{CC}$ .* CD54/74HC Types	2	6	V
CD54/74HCT Types	4.5	5.5	V
DC Input or Output Voltage $V_I, V_O$	0	$V_{CC}$	V
Operating Temperature $T_A$ : CD74 Types	-40	+85	$^\circ\text{C}$
CD54 Types	-55	+125	$^\circ\text{C}$
Input Rise and Fall Times, $t_r, t_f$ at 2 V	0	1000	ns
at 4.5 V	0	500	ns
at 6 V	0	400	ns

\*Unless otherwise specified, all voltages are referenced to Ground.

# CD54/74HC4046A

## CD54/74HCT4046A

### PIN DESCRIPTION

PIN NO.	SYMBOL	NAME AND FUNCTION
1	PCP <sub>OUT</sub>	phase comparator pulse output
2	PC1 <sub>OUT</sub>	phase comparator 1 output
3	COMP <sub>IN</sub>	comparator input
4	VCO <sub>OUT</sub>	VCO output
5	INH	inhibit input
6	C1 <sub>A</sub>	capacitor C1 connection A
7	C1 <sub>B</sub>	capacitor C1 connection B
8	GND	ground (0 V)
9	VCO <sub>IN</sub>	VCO input
10	DEM <sub>OUT</sub>	demodulator output
11	R <sub>1</sub>	resistor R1 connection
12	R <sub>2</sub>	resistor R2 connection
13	PC2 <sub>OUT</sub>	phase comparator 2 output
14	SIG <sub>IN</sub>	signal input
15	PC3 <sub>OUT</sub>	phase comparator 3 output
16	V <sub>CC</sub>	positive supply voltage

### GENERAL DESCRIPTION

#### VCO

The VCO requires one external capacitor C1 (between C1<sub>A</sub> and C1<sub>B</sub>) and one external resistor R1 (between R<sub>1</sub> and GND) or two external resistors R1 and R2 (between R<sub>1</sub> and GND, and R<sub>2</sub> and GND). Resistor R1 and capacitor C1 determine the frequency range of the VCO. Resistor R2 enables the VCO to have a frequency offset if required. See logic diagram, Fig. 1.

The high input impedance of the VCO simplifies the design of low-pass filters by giving the designer a wide choice of resistor/capacitor ranges. In order not to load the low-pass filter, a demodulator output of the VCO input voltage is provided at pin 10 (DEM<sub>OUT</sub>). In contrast to conventional techniques where the DEM<sub>OUT</sub> voltage is one threshold voltage lower than the VCO input voltage, here the DEM<sub>OUT</sub> voltage equals that of the VCO input. If DEM<sub>OUT</sub> is used, a load resistor (R<sub>S</sub>) should be connected from DEM<sub>OUT</sub> to GND; if unused, DEM<sub>OUT</sub> should be left open. The VCO output (VCO<sub>OUT</sub>) can be connected directly to the comparator input (COMP<sub>IN</sub>), or connected via a frequency-divider. The VCO output signal has a guaranteed duty factor of 50%. A LOW level at the inhibit input (INH) enables the VCO and demodulator, while a HIGH level turns both off to minimize standby power consumption.

#### Phase Comparators

The signal input (SIG<sub>IN</sub>) can be directly coupled to the self-biasing amplifier at pin 14, provided that the signal swing is between the standard HC family input logic levels. Capacitive coupling is required for signals with smaller swings.

#### Phase comparator 1 (PC1)

This is an Exclusive-OR network. The signal and comparator input frequencies (f<sub>i</sub>) must have a 50% duty factor to obtain the maximum locking range. The transfer characteristic of PC1, assuming ripple (f<sub>r</sub> = 2f<sub>i</sub>) is suppressed, is:

$V_{\text{DEMOUT}} = (V_{\text{CC}}/\pi) (\phi_{\text{SIGIN}} - \phi_{\text{COMPIN}})$  where V<sub>DEMOUT</sub> is the demodulator output at pin 10; V<sub>DEMOUT</sub> = V<sub>PC1OUT</sub> (via low-pass filter).

The average output voltage from PC1, fed to the VCO input via the low-pass filter and seen at the demodulator output at pin 10 (V<sub>DEMOUT</sub>), is the resultant of the phase differences of signals (SIG<sub>IN</sub>) and the comparator input (COMP<sub>IN</sub>) as shown in Fig. 2. The average of V<sub>DEM</sub> is equal to 1/2 V<sub>CC</sub> when there is no signal or noise at SIG<sub>IN</sub>, and with this input the VCO oscillates at the center frequency (f<sub>o</sub>). Typical waveforms for the PC1 loop locked at f<sub>o</sub> are shown in Fig. 3.

**CD54/74HC4046A**  
**CD54/74HCT4046A**

HARRIS SEMICOND SECTOR

27E D ■ 430227J 0017903 0 ■ HAS

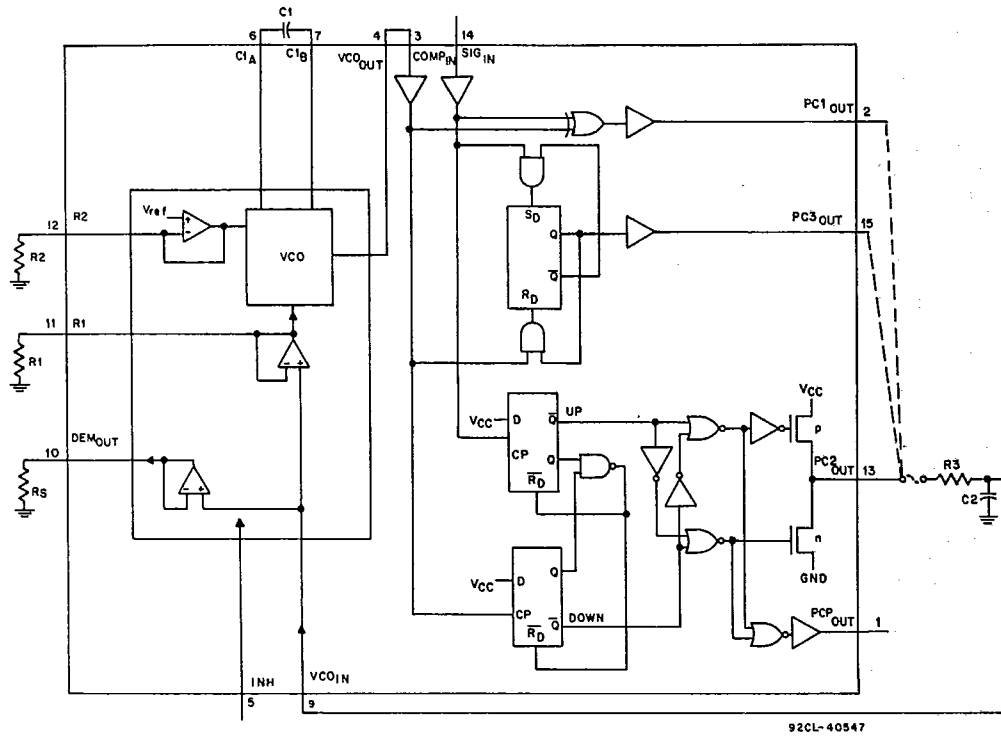

Fig. 1 — Logic diagram.

The frequency capture range ( $2f_c$ ) is defined as the frequency range of input signals on which the PLL will lock if it was initially out-of-lock. The frequency lock range ( $2f_L$ ) is defined as the frequency range of input signals on which the loop will stay locked if it was initially in lock. The capture range is smaller or equal to the lock range.

With PC1, the capture range depends on the low-pass filter characteristics and can be made as large as the lock range. This configuration retains lock behavior even with very noisy input signals. Typical of this type of phase comparator is that it can lock to input frequencies close to the harmonics of the VCO center frequency.

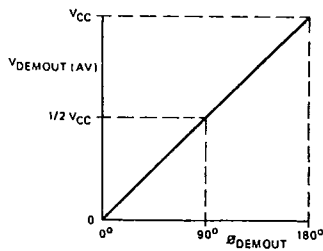

Fig. 2 — Phase comparator 1: average output voltage versus input phase difference:

$$V_{\text{DEMOUT}} = V_{\text{PC1OUT}} = \frac{V_{\text{CC}}}{\pi} (\phi_{\text{SIGIN}} - \phi_{\text{COMPIN}});$$

$$\phi_{\text{DEMOUT}} = (\phi_{\text{SIGIN}} - \phi_{\text{COMPIN}}).$$

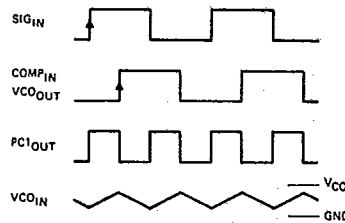

Fig. 3 — Typical waveforms for PLL using phase comparator 1, loop locked at  $f_0$ .

# CD54/74HC4046A

## CD54/74HCT4046A

### Phase Comparator 2 (PC2)

This is a positive edge-triggered phase and frequency detector. When the PLL is using this comparator, the loop is controlled by positive signal transitions and the duty factors of  $SIG_{IN}$  and  $COMP_{IN}$  are not important. PC2 comprises two D-type flip-flops, control-gating and a 3-state output stage. The circuit functions as an up-down counter (Fig. 1) where  $SIG_{IN}$  causes an up-count and  $COMP_{IN}$  a down-count. The transfer function of PC2, assuming ripple ( $f_r = f_i$ ) is suppressed, is:

$V_{DEMOUT} = (V_{CC}/4\pi) (\phi_{SIGIN} - \phi_{COMPIN})$  where  $V_{DEMOUT}$  is the demodulator output at pin 10;  $V_{DEMOUT} = V_{PC2OUT}$  (via low-pass filter).

The average output voltage from PC2, fed to the VCO via the low-pass filter and seen at the demodulator output at pin 10 ( $V_{DEMOUT}$ ), is the resultant of the phase differences of  $SIG_{IN}$  and  $COMP_{IN}$  as shown in Fig. 4. Typical waveforms for the PC2 loop locked at  $f_0$  are shown in Fig. 5.

When the frequencies of  $SIG_{IN}$  and  $COMP_{IN}$  are equal but the phase of  $SIG_{IN}$  leads that of  $COMP_{IN}$ , the p-type output driver at  $PC2_{OUT}$  is held "ON" for a time corresponding to the phase difference ( $\phi_{DEMOUT}$ ). When the phase of  $SIG_{IN}$  lags that of  $COMP_{IN}$ , the n-type driver is held "ON".

When the frequency of  $SIG_{IN}$  is higher than that of  $COMP_{IN}$ , the p-type output driver is held "ON" for most of the input signal cycle time, and for the remainder of the cycle both n- and p-type drivers are "OFF" (3-state). If the  $SIG_{IN}$  frequency is lower than the  $COMP_{IN}$  frequency, then it is the n-type driver that is held "ON" for most of the cycle. Subsequently, the voltage at the capacitor (C2) of the low-pass filter connected to  $PC2_{OUT}$  varies until the signal and comparator inputs are equal in both phase and frequency. At this stable point the voltage on C2 remains constant as the  $PC2$  output is in 3-state and the VCO input at pin 9 is a high impedance. Also in this condition, the signal at the phase comparator pulse output ( $PCP_{OUT}$ ) is a HIGH level and so can be used for indicating a locked condition.

Thus, for PC2, no phase difference exists between  $SIG_{IN}$  and  $COMP_{IN}$  over the full frequency range of the VCO. Moreover, the power dissipation due to the low-pass filter is reduced because both p- and n-type drivers are "OFF" for most of the signal input cycle. It should be noted that the PLL lock range for this type of phase comparator is equal to the capture range and is independent of the low-pass filter. With no signal present at  $SIG_{IN}$ , the VCO adjusts, via PC2, to its lowest frequency.

### Phase comparator 3 (PC3)

This is a positive edge-triggered sequential phase detector using an RS-type flip-flop. When the PLL is using this comparator, the loop is controlled by positive signal transitions and the duty factors of  $SIG_{IN}$  and  $COMP_{IN}$  are not important. The transfer characteristic of PC3, assuming ripple ( $f_r = f_i$ ) is suppressed, is:

$V_{DEMOUT} = (V_{CC}/2\pi) (\phi_{SIGIN} - \phi_{COMPIN})$  where  $V_{DEMOUT}$  is the demodulator output at pin 10;  $V_{DEMOUT} = V_{PC3OUT}$  (via low-pass filter).

The average output voltage from PC3, fed to the VCO via the low-pass filter and seen at the demodulator at pin 10 ( $V_{DEMOUT}$ ), is the resultant of the phase differences of  $SIG_{IN}$  and  $COMP_{IN}$  as shown in Fig. 6. Typical waveforms for the PC3 loop locked at  $f_0$  are shown in Fig. 7.

The phase-to-output response characteristic of PC3 (Fig. 6) differs from that of PC2 in that the phase angle between  $SIG_{IN}$  and  $COMP_{IN}$  varies between  $0^\circ$  and  $360^\circ$  and is  $180^\circ$  at

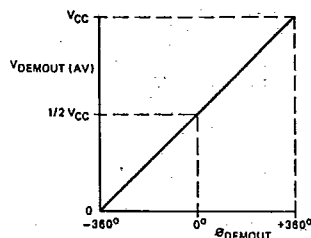

Fig 4 — Phase comparator 2: average output voltage versus input phase difference:  
 $V_{DEMOUT} = V_{PC2OUT} = (V_{CC}/4\pi) (\phi_{SIGIN} - \phi_{COMPIN})$ ;  
 $\phi_{DEMOUT} = (\phi_{SIGIN} - \phi_{COMPIN})$ .

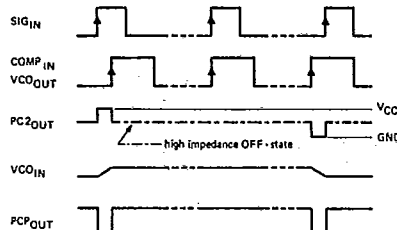

Fig. 5 — Typical waveforms for PLL using phase comparator 2, loop locked at  $f_0$ .

the center frequency. Also PC3 gives a greater voltage swing than PC2 for input phase differences but as a consequence the ripple content of the VCO input signal is higher. With no signal present at  $SIG_{IN}$ , the VCO adjusts, via PC3, to its highest frequency.

The only difference between the HC and the HCT versions is the input level specification of the INH input. This input disables the VCO section. The comparators' sections are identical, so that there is no difference in the  $SIG_{IN}$  (pin 14) or  $COMP_{IN}$  (pin 3) inputs between the HC and the HCT versions.

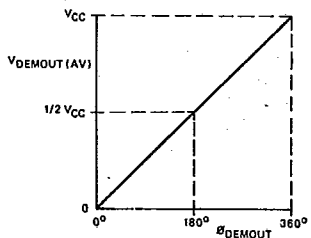

Fig. 6 — Phase comparator 3: average output voltage versus input phase difference:  
 $V_{DEMOUT} = V_{PC3OUT} = (V_{CC}/2\pi) (\phi_{SIGIN} - \phi_{COMPIN})$ ;  
 $\phi_{DEMOUT} = (\phi_{SIGIN} - \phi_{COMPIN})$ .

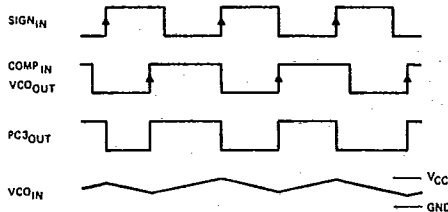

Fig. 7 — Typical waveforms for PLL using phase comparator 3, loop locked at  $f_0$ .

**CD54/74HC4046A**  
**CD54/74HCT4046A**

STATIC ELECTRICAL CHARACTERISTICS

CHARACTERISTIC	CD74HC4046A/CD54HC4046A										CD74HCT4046A/CD54HCT4046A								UNITS			
	TEST CONDITIONS			74HC/54HC TYPES			74HC TYPE		54HC TYPE			TEST CONDITIONS		74HCT/54HCT TYPES			74HCT TYPE			54HCT TYPE		
	V <sub>I</sub> V	I <sub>O</sub> mA	V <sub>CC</sub> V	+25°C			-40/ +85°C		-55/ +125°C			V <sub>I</sub> V	V <sub>CC</sub> V	+25°C			-40/ +85°C			-55/ +125°C		
				Min	Typ	Max	Min	Max	Min	Max	Min			Max	Min	Max	Min	Max				
VCO SECTION																						
	INH High-Level Input Voltage	V <sub>ih</sub>		3	2.1	—	—	2.1	—	2.1	—	—	4.5		2	—	—	2	—	2	—	V
				4.5	3.15	—	—	3.15	—	3.15	—	—	5.5	to	—	—	—	—	—	—	—	
			6	4.2	—	—	4.2	—	4.2	—	—											
INH Low-Level Input Voltage	V <sub>il</sub>		3	—	—	0.9	—	0.9	—	0.9	—	—	4.5	to	—	—	0.8	—	0.8	—	0.8	V
			4.5	—	—	1.35	—	1.35	—	1.35	—	—	5.5	—	—	—	—	—	—	—	—	
			6	—	—	1.8	—	1.8	—	1.8	—											
VCO <sub>out</sub> High-Level Output Voltage	V <sub>oh</sub>		3	2.9	—	—	2.9	—	2.9	—	—	V <sub>ih</sub>										V
	or	-0.02	4.5	4.4	—	—	4.4	—	4.4	—	—	4.5	4.4	—	—	4.4	—	4.4	—	4.4	—	
	CMOS Loads	V <sub>ih</sub>	6	5.9	—	—	5.9	—	5.9	—	—	V <sub>ih</sub>										
TTL Loads	V <sub>oh</sub>										V <sub>ih</sub>											V
	or	-4	4.5	3.98	—	—	3.84	—	3.7	—	—	4.5	3.98	—	—	3.84	—	3.7	—	—	—	
	V <sub>ih</sub>	-5.2	6	5.48	—	—	5.34	—	5.2	—	—	V <sub>ih</sub>										
VCO <sub>out</sub> Low-Level Output Voltage	V <sub>ol</sub>		2	—	—	0.1	—	0.1	—	0.1	—	V <sub>ih</sub>										V
	or	0.02	4.5	—	—	0.1	—	0.1	—	0.1	—	or	4.5	—	—	0.1	—	0.1	—	0.1	—	
	CMOS Loads	V <sub>ih</sub>	6	—	—	0.1	—	0.1	—	0.1	—	V <sub>ih</sub>										
TTL Loads	V <sub>ol</sub>										V <sub>ih</sub>											V
	or	1	4.5	—	—	0.26	—	0.33	—	0.4	—	or	4.5	—	—	0.26	—	0.33	—	0.4	—	
	V <sub>ih</sub>	5.2	6	—	—	0.26	—	0.33	—	0.4	—	V <sub>ih</sub>										
C1A, C1B Low Level Output Voltage (Test purposes only)	V <sub>oh</sub>										V <sub>ih</sub>											V
	or	4	4.5	—	—	0.40	—	0.47	—	0.54	—	or	4.5	—	—	0.40	—	0.47	—	0.54	—	
	V <sub>ih</sub>	5.2	6	—	—	0.40	—	0.47	—	0.54	—	V <sub>ih</sub>										
INH VCO <sub>in</sub> Input Leakage Current	I <sub>l</sub>	V <sub>CC</sub> or Gnd	6	—	—	±0.1	—	±1	—	±1	—	Any Voltage Between V <sub>CC</sub> and Gnd	5.5	—	—	±0.1	—	±1	—	±1	—	μA
R1 Range			3	—	—	—	—	—	—	—	—											kΩ
			4.5	3	—	300	—	—	—	—	—		4.5	3	—	300	—	—	—	—	—	
			6	—	—	—	—	—	—	—	—											
R2 Range			3	—	—	—	—	—	—	—	—											kΩ
			4.5	3	—	300	—	—	—	—	—		3	—	300	—	—	—	—	—	—	
			6	—	—	—	—	—	—	—	—											
C1 Capacitance Range			3			No L I M I T																pF
			4.5	0									0									
			6																			
VCO <sub>in</sub> Operating Voltage Range		Over the range specified for R1 for Linearity See Figs. 8 & 35-38 See Note 2	3	0.9		1.9							4.5	0.9		3.2						V
			4.5	0.9		3.2																
			6	0.9		4.8																

NOTES: 1. The value for R1 & R2 in parallel should exceed 2.7 kΩ.  
2. The maximum operating voltage can be as high as V<sub>CC</sub> -0.9 V, however, this may result in an increased offset voltage.

HARRIS SEMICONDUCTOR SECTOR 27E D 4302271 0017905 4 HAS

**CD54/74HC4046A**  
**CD54/74HCT4046A**

STATIC ELECTRICAL CHARACTERISTICS

CHARACTERISTIC	CD74HC4046A/CD54HC4046A										CD74HCT4046A/CD54HCT4046A								UNITS						
	TEST CONDITIONS			74HC/54HC TYPES			74HC TYPE		54HC TYPE		TEST CONDITIONS		74HCT/54HCT TYPES			74HCT TYPE		54HCT TYPE							
	V <sub>I</sub> V	I <sub>O</sub> mA	V <sub>CC</sub> V	+25°C			-40/ +85°C		-55/ +125°C		V <sub>I</sub> V	V <sub>CC</sub> V	+25°C			-40/ +85°C		-55/ +125°C							
				Min	Typ	Max	Min	Max	Min	Max			Min	Typ	Max	Min	Max	Min		Max					
SIG <sub>IN</sub> , COMP <sub>IN</sub> DC Coupled High-Level Input Voltage V <sub>IH</sub>			2	1.5	—	—	1.5	—	1.5	—		4.5											V		
			4.5	3.15	—	—	3.15	—	3.15	—		to	2	—	—	2	—	2	—					V	
			6	4.2	—	—	4.2	—	4.2	—		5.5												V	
SIG <sub>IN</sub> , COMP <sub>IN</sub> DC Coupled Low-Level Input Voltage V <sub>IL</sub>			2	—	—	0.5	—	0.5	—	0.5		4.5												V	
			4.5	—	—	1.35	—	1.35	—	1.35		to	—	—	0.8	—	0.8	—	0.8	—					V
			6	—	—	1.8	—	1.8	—	1.8		5.5												V	
PCP <sub>OUT</sub> , PCn <sub>OUT</sub> High-Level Output Voltage V <sub>OH</sub>	V <sub>IL</sub>		2	1.9	—	—	1.9	—	1.9	—	V <sub>IL</sub>													V	
	or	-0.02	4.5	4.4	—	—	4.4	—	4.4	—	or	4.5	4.4	—	—	4.4	—	4.4	—					V	
	V <sub>IH</sub>		6	5.9	—	—	5.9	—	5.9	—	V <sub>IH</sub>													V	
TTL Loads	V <sub>IL</sub>										V <sub>IL</sub>													V	
	or	-4	4.5	3.98	—	—	3.84	—	3.7	—	or	4.5	3.98	—	—	3.84	—	3.7	—					V	
	V <sub>IH</sub>	-5.2	6	5.48	—	—	5.34	—	5.2	—	V <sub>IH</sub>													V	
PCP <sub>OUT</sub> , PCn <sub>OUT</sub> Low-Level Output Voltage V <sub>OL</sub>	V <sub>IL</sub>		2	—	—	0.1	—	0.1	—	0.1	V <sub>IL</sub>													V	
	or	0.02	4.5	—	—	0.1	—	0.1	—	0.1	or	4.5	—	—	0.1	—	0.1	—	0.1	—				V	
	V <sub>IH</sub>		6	—	—	0.1	—	0.1	—	0.1	V <sub>IH</sub>													V	
TTL Loads	V <sub>IL</sub>										V <sub>IL</sub>													V	
	or	4	4.5	—	—	0.26	—	0.33	—	0.4	or	4.5	—	—	0.26	—	0.33	—	0.4	—				V	
	V <sub>IH</sub>	5.2	6	—	—	0.26	—	0.33	—	0.4	V <sub>IH</sub>													V	
SIG <sub>IN</sub> , COMP <sub>IN</sub> Input Leakage Current I <sub>I</sub>	V <sub>CC</sub>		2	—	—	±3	—	±4	—	±5	Any Voltage Between V <sub>CC</sub> and Gnd	5.5	—	—	±30	—	±38	—	±45					μA	
	or		3	—	—	±7	—	±9	—	±11															
	Gnd		4.5	—	—	±18	—	±23	—	±29															
			6	—	—	±30	—	±38	—	±45															
PC2 OUT 3-State Off-State Current I <sub>oz</sub>	V <sub>IL</sub>		6	—	—	±0.5	—	±5	—	±10		5.5	—	—	±0.5	±5	—	—	—	—	—	—	±10	μA	
	V <sub>IH</sub>																							μA	
SIG <sub>IN</sub> , COMP <sub>IN</sub> Input Resistance R <sub>i</sub>	V <sub>I</sub> at Self-Bias Oper. Point. ΔV <sub>I</sub> = 0.5 V See Fig. 8		3	—	800	—	—	—	—	—		4.5	—	250	—	—	—	—	—	—	—	—	—	kΩ	
			4.5	—	250	—	—	—	—	—															
			6	—	150	—	—	—	—	—															

HARRIS SEMICONDUCTOR 27E D 430227J 0017906 6 HAS

**CD54/74HC4046A**  
**CD54/74HCT4046A**

STATIC ELECTRICAL CHARACTERISTICS

CHARACTERISTIC	CD74HC4046A/CD54HC4046A										CD74HCT4046A/CD54HCT4046A								UNITS		
	TEST CONDITIONS			74HC/54HC TYPES			74HC TYPE		54HC TYPE		TEST CONDITIONS		74HCT/54HCT TYPES			74HCT TYPE		54HCT TYPE			
	V <sub>I</sub> V	I <sub>O</sub> mA	V <sub>CC</sub> V	+25°C			-40/ +85°C		-55/ +125°C		V <sub>I</sub> V	V <sub>CC</sub> V	+25°C			-40/ +85°C		-55/ +125°C			
				Min	Typ	Max	Min	Max	Min	Max			Min	Typ	Max	Min	Max	Min		Max	
Resistor Range R <sub>s</sub>	at R <sub>s</sub> > 300 kΩ Leakage Current can influence V <sub>DEM out</sub>		3	50	—	300						4.5	5	—	300						kΩ
Offset Voltage V <sub>COIN</sub> to V <sub>DEM</sub> V <sub>OFF</sub>	V <sub>I</sub> = V <sub>COIN</sub> - $\frac{V_{CC}}{2}$ Values taken over R <sub>s</sub> range See Fig 15		3	—	±30	—						4.5	—	±20	—						mV
Dynamic Output Resistance at DEM <sub>OUT</sub> R <sub>O</sub>	V <sub>DEM out</sub> = $\frac{V_{CC}}{2}$		3	—	25	—						4.5	—	25	—						Ω
Quiescent Device Current I <sub>CC</sub>	Pins 3, 5 & 14 at V <sub>CC</sub> Pin 9 at Gnd. I <sub>1</sub> at Pins 3 & 14 to be excluded		6	—	—	8	—	80	—	160	V <sub>CC</sub> or Gnd	5.5	—	—	8	—	80	—	160		μA
Additional Quiescent Device Current Per Input Pin 1 unit load ΔI <sub>CC</sub> *										V <sub>CC</sub> -2.1 (Excluding Pin 5)	4.5 to 5.5	—	100	360	—	450	—	490			μA

\*For dual-supply systems theoretical worst case (V<sub>I</sub> = 2.4 V, V<sub>CC</sub> = 5.5 V) specification is 1.8 mA.

HCT Input Loading Table

Input	Unit Loads*
INH	1

\*Unit Load is ΔI<sub>CC</sub> limit specified in Static Characteristics Chart, e.g. 360 μA max. @ 25°C.

HARRIS SEMICONDUCTOR SECTOR 27E D 430227J 00J7907 & HAS



**CD54/74HC4046A**  
**CD54/74HCT4046A**

SWITCHING CHARACTERISTICS ( $C_L = 50 \text{ pF}$ , Input  $t_r, t_f = 6 \text{ ns}$ )

CHARACTERISTIC	TEST CONDITIONS		25°C				-40°C to +85°C				-55°C to +125°C				UNITS
	$V_{CC}$		HC		HCT		74HC		74HCT		54HC		54HCT		
			Min.	Max.	Min.	Max.	Min.	Max.	Min.	Max.	Min.	Max.	Min.	Max.	
<b>PHASE COMPARATOR SECTION</b>															
Propagation Delay, SIG <sub>IN</sub> , COMP <sub>IN</sub> to PC1 <sub>OUT</sub>	$t_{PLH}$ $t_{PHL}$	2 4.5 6	— — —	200 40 34	— — —	— 45 —	— — —	250 50 43	— — —	— 58 —	— — —	300 60 51	— — —	— 68 —	ns
SIG <sub>IN</sub> , COMP <sub>IN</sub> to PC2 <sub>OUT</sub>		2 4.5 6	— — —	300 60 51	— — —	— 68 —	— — —	375 75 64	— — —	— 85 —	— — —	450 90 77	— — —	— 102 —	
SIG <sub>IN</sub> , COMP <sub>IN</sub> to PC3 <sub>OUT</sub>		2 4.5 6	— — —	245 49 42	— — —	— 58 —	— — —	305 61 52	— — —	— 73 —	— — —	307 74 63	— — —	— 87 —	
Output Transition Time	$t_{THL}$ $t_{TLH}$	2 4.5 6	— — —	75 15 13	— — —	— 15 —	— — —	95 19 16	— — —	— 19 —	— — —	110 22 19	— — —	— 22 —	
Output Enable Time, SIG <sub>IN</sub> , COMP <sub>IN</sub> to PC2 <sub>OUT</sub>	$t_{PZH}$ $t_{PZL}$	2 4.5 6	— — —	265 53 45	— — —	— 60 —	— — —	330 66 56	— — —	— 75 —	— — —	400 80 68	— — —	— 90 —	
Output Disable Time, SIG <sub>IN</sub> , COMP <sub>IN</sub> to PC2 <sub>OUT</sub>	$t_{PHZ}$ $t_{PLZ}$	2 4.5 6	— — —	315 63 54	— — —	— 68 —	— — —	395 79 67	— — —	— 85 —	— — —	475 95 81	— — —	— 102 —	
AC Coupled Input Sensitivity (p-p) at SIG <sub>IN</sub> or COMP <sub>IN</sub>	$V_i$ (p-p)	3 4.5 6	TYPICAL											mV	
<b>VCO SECTION</b>															
Frequency Stability with Temperature Change	$\frac{\Delta f}{\Delta T}$	$R_1 = 100k\Omega$ $R_2 = \infty$	3 4.5 6					Typ. 0.11	Typ. 0.11					%/°C	
Max. Frequency	$f_{max}$	$C_i = 50 \text{ pF}$ $R_1 = 3.5k\Omega$ $R_2 = \infty$	3 4.5 6	24	24									MHz	
		$C_i = 0 \text{ pF}$ $R_1 = 9.1k\Omega$ $R_2 = \infty$	3 4.5 6	38	38									MHz	
Center Frequency		$C_i = 40 \text{ pF}$ $R_1 = 3k\Omega$ $R_2 = \infty$ $VCO_{IN} = \frac{V_{CC}}{2}$	3 4.5 6	17	17									MHz	
Frequency Linearity, $\Delta f_{VCO}$		$R_1 = 100k\Omega$ $R_2 = \infty$ $C_i = 100 \text{ pF}$	3 4.5 6	0.4	0.4									%	
Offset Frequency		$R_2 = 220k\Omega$ $C_i = 1 \text{ nF}$	3 4.5 6	400	400									kHz	
<b>DEMODULATOR SECTION</b>															
$V_{OUT}$ Vs $f_{IN}$		$R_1 = 100 \text{ k}\Omega$ $R_2 = \infty$ $C_i = 100 \text{ pF}$ $R_5 = 10 \text{ k}\Omega$ $R_3 = 100 \text{ k}\Omega$ $C_2 = 100 \text{ pF}$	3 4.5 6	— 330 —	— 330 —									mV/kHz	

HARRIS SEMICONDUCTOR 27E D 430227J 0017908 T HAS

# CD54/74HC406A CD54/74HCT406A

Figure References for DC Characteristics

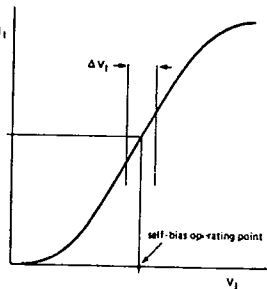

Fig. 8 - Typical input resistance curve at SIG<sub>IN</sub>, COMP<sub>IN</sub>

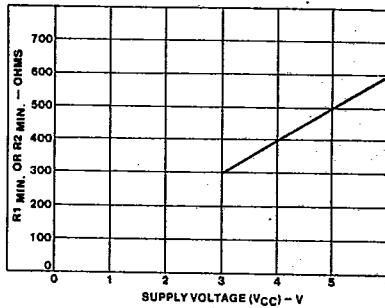

Fig. 9-HC/HCT406A R1 (min) or R2 (min) vs supply voltage (V<sub>cc</sub>).

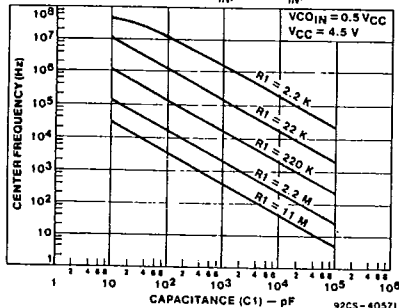

Fig. 10-HCT406A typical center frequency vs R1, C1 (V<sub>cc</sub>=4.5 V).

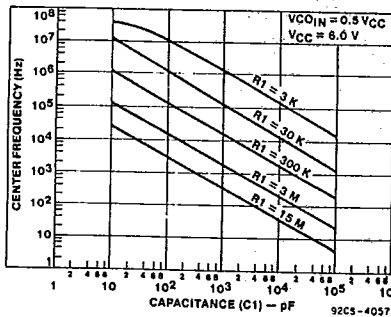

Fig. 11-HC406A typical center frequency vs R1, C1 (V<sub>cc</sub>=6 V).

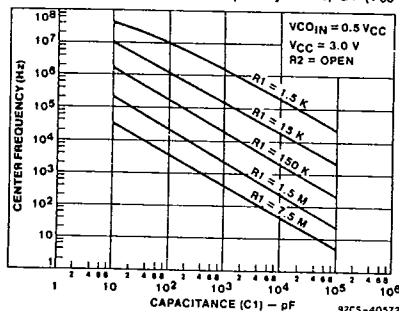

Fig. 12-HC406A typical center frequency vs R1, C1 (V<sub>cc</sub>=3 V, R2=open).

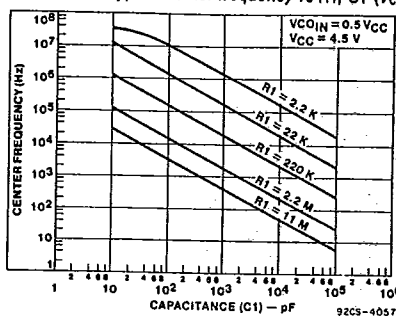

Fig. 13-HCT406A typical center frequency vs R1, C1 (V<sub>cc</sub>=4.5 V).

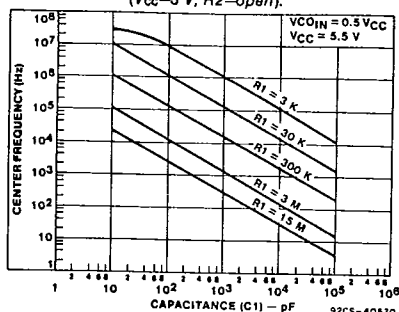

Fig. 14-HCT406A typical center frequency vs R1, C1 (V<sub>cc</sub>=5.5 V).

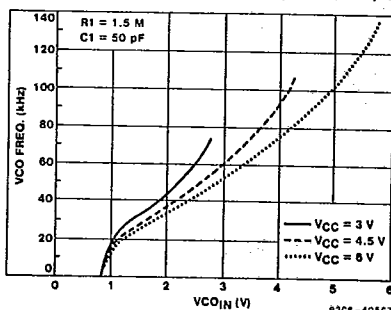

Fig. 15-HC406A typical VCO frequency vs VCO<sub>IN</sub> (R1=1.5 MΩ, C1=50 pF).

HARRIS SEMICONDUCTOR 27E D 4302271 0017909 1 HAS

# CD54/74HC4046A CD54/74HCT4046A

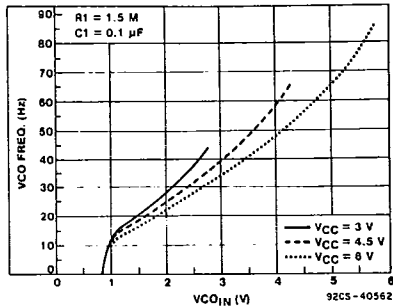

Fig. 16-HC4046A typical VCO frequency vs VCO<sub>IN</sub> (R1=1.5 MΩ, C1=0.1 μF).

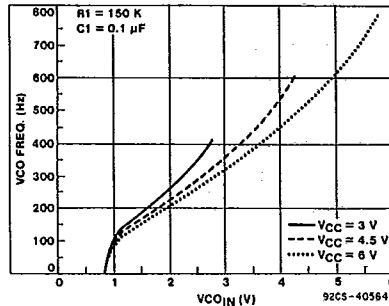

Fig. 17-HC4046A typical VCO frequency vs VCO<sub>IN</sub> (R1=150 kΩ, C1=0.1 μF).

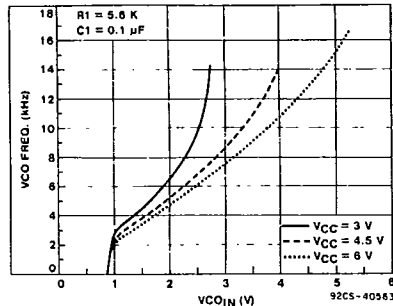

Fig. 18-HC4046A typical VCO frequency vs VCO<sub>IN</sub> (R1=5.6 kΩ, C1=0.1 μF).

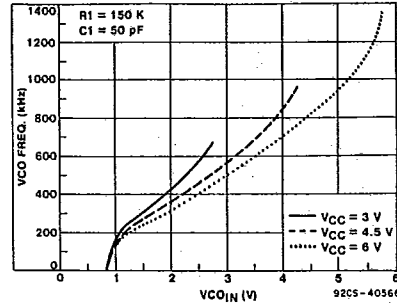

Fig. 19-HC4046A typical VCO frequency vs VCO<sub>IN</sub> (R1=150 kΩ, C1=50 pF).

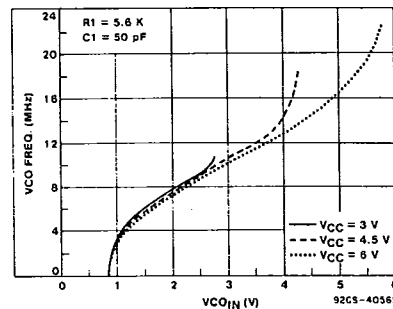

Fig. 20-HC4046A typical VCO frequency vs VCO<sub>IN</sub> (R1=5.6 kΩ, C1=50 pF).

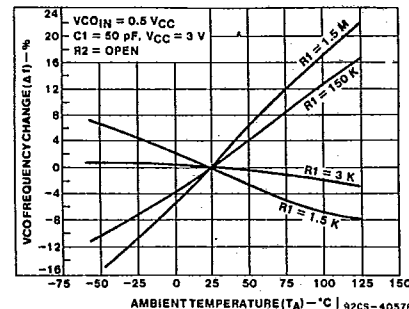

Fig. 21-HC4046A typical change in VCO frequency vs ambient temperature as a function of R1 (V<sub>CC</sub>=3 V).

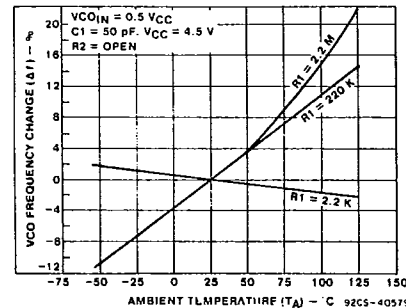

Fig. 22-HC4046A typical change in VCO frequency vs ambient temperature as a function of R1 (V<sub>CC</sub>=4.5 V).

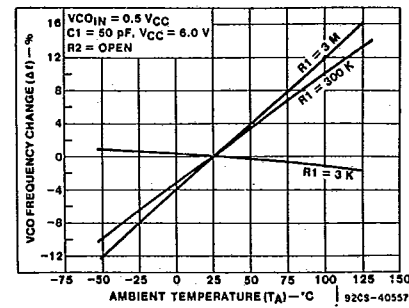

Fig. 23-HC4046A typical change in VCO frequency vs ambient temperature as a function of R1 (V<sub>CC</sub>=6 V).

**CD54/74HC4046A**  
**CD54/74HCT4046A**

HARRIS SEMICOND SECTOR

27E D

4302271 0017911 T HAS

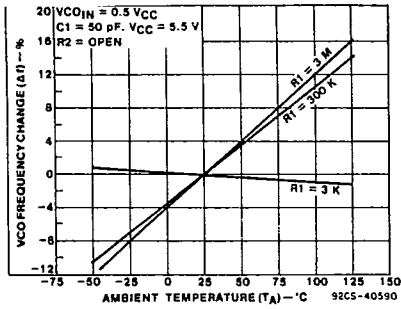

Fig. 24-HCT4046A typical change in VCO frequency vs ambient temperature as a function of R1.

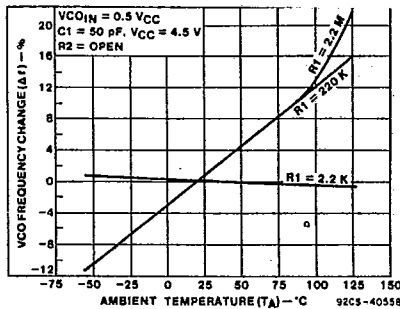

Fig. 25-HC4046A typical change in VCO frequency vs ambient temperature as a function of R1 (VCC=4.5 V).

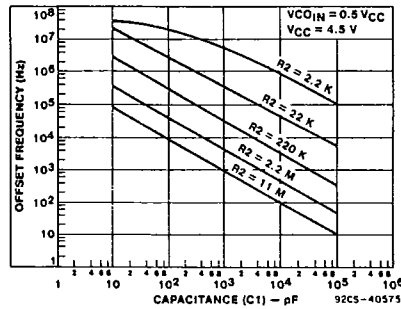

Fig. 26-HC4046A offset frequency vs R2, C1 (VCC=4.5 V).

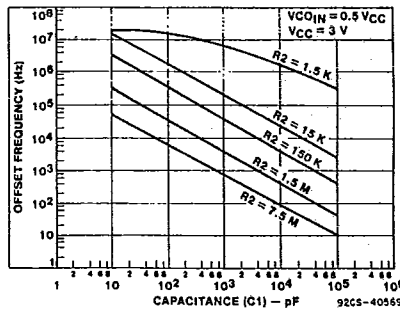

Fig. 27-HC4046A offset frequency vs R2, C1 (VCC=3 V).

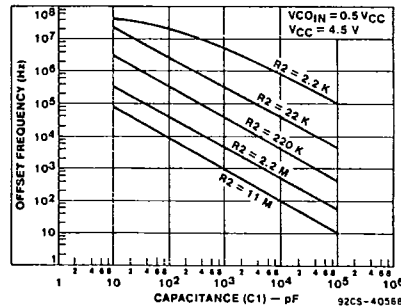

Fig. 28-HCT4046A offset frequency vs R2, C1 (VCC=4.5 V).

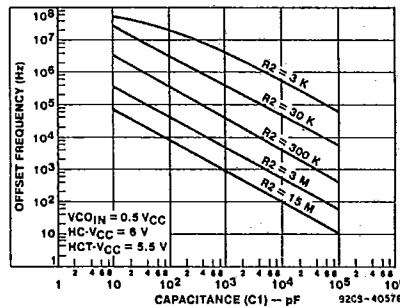

Fig. 29-HC4046A & HCT4046A offset frequency vs R2, C1 (VCC=6 V, VCC=5.5 V).

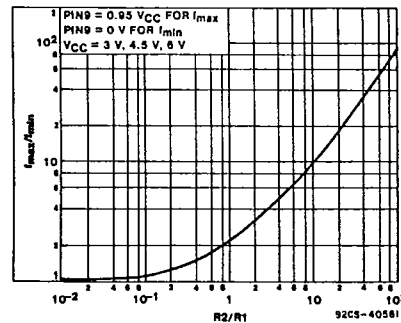

Fig. 30-HC4046A  $I_{max}/I_{min}$  vs R2/R1 (VCC=3 V, 4.5 V, 6 V).

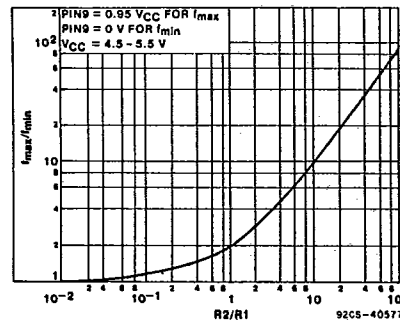

Fig. 31-HCT4046A  $I_{max}/I_{min}$  vs R2/R1 (VCC=4.5 V-5.5 V).

**CD54/74HC4046A**  
**CD54/74HCT4046A**

**AC WAVEFORMS**

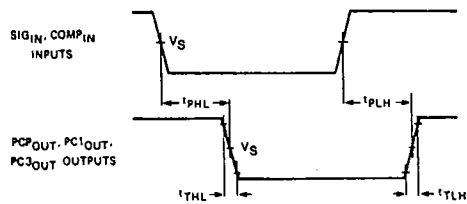

Fig. 32 — Waveforms showing input ( $SIG_{IN}$ ,  $COMP_{IN}$ ) to output ( $PCP_{OUT}$ ,  $PC1_{OUT}$ ,  $PC3_{OUT}$ ) propagation delays and the output transition times.

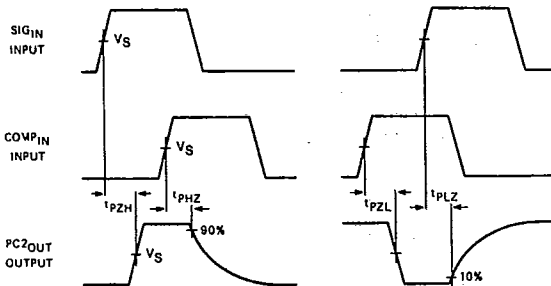
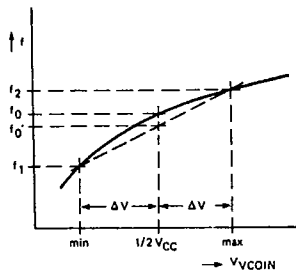

Fig. 33 — Waveforms showing the 3-state enable and disable times for  $PC2_{OUT}$ .

	HC	HCT
INPUT LEVEL	$V_{CC}$	3 V
SWITCHING VOLTAGE, $V_S$	50% $V_{CC}$	1.3 V



$\Delta V = 0.5$  V over the  $V_{CC}$  range:

for VCO linearity

$$f'_o = \frac{f_1 + f_2}{2}$$

$$\text{linearity} = \frac{f'_o - f_0}{f'_o} \times 100\%$$

Fig. 34 — Definition of VCO frequency linearity.

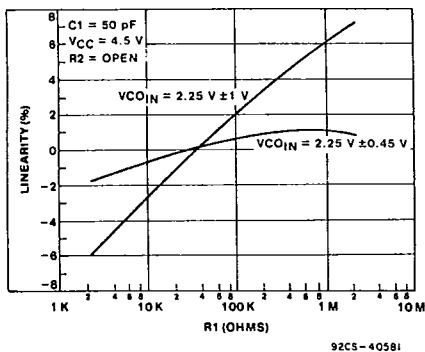

Fig. 35—HC4046A VCO linearity vs  $R1$  ( $V_{CC}=4.5$  V).

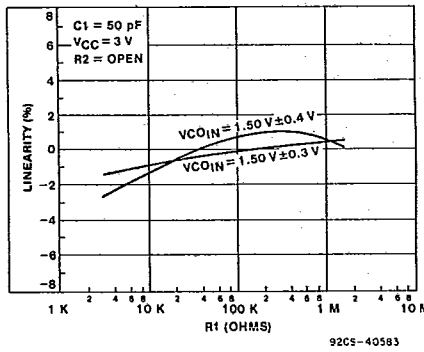

Fig. 36—HC4046A VCO linearity vs  $R1$  ( $V_{CC}=3$  V).

HARRIS SEMICONDUCTOR 27E D 430227J 00179J2 J HAS

# CD54/74HC4046A CD54/74HCT4046A

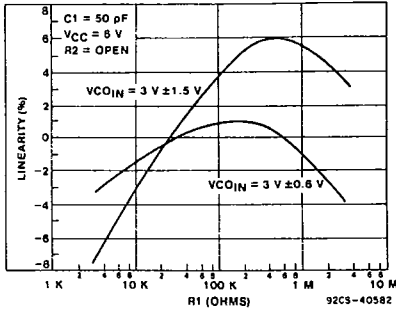

Fig. 37- HC4046A VCO linearity vs R1 (V<sub>CC</sub>=6 V).

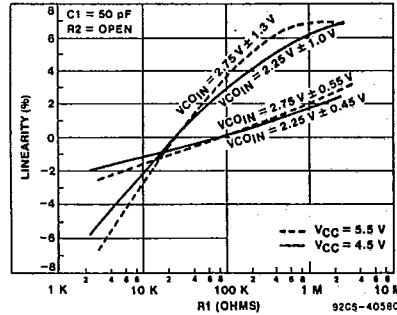

Fig. 38- HCT4046A VCO linearity vs R1 (V<sub>CC</sub>=4.5 V, V<sub>CC</sub>=5.5 V).

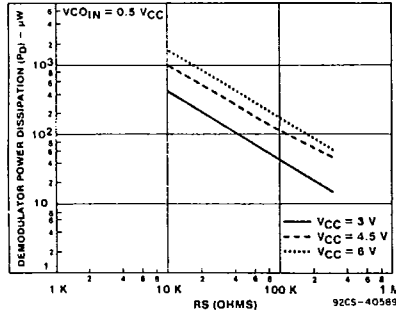

Fig. 39- HC4046A demodulator power dissipation vs RS (typ.) (V<sub>CC</sub>=3 V; 4.5 V; 6 V).

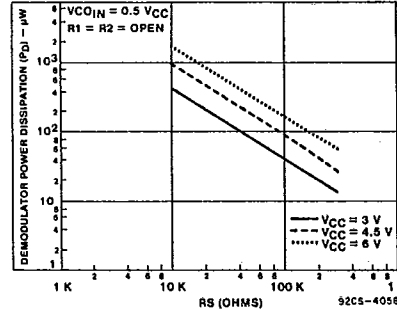

Fig. 40- HCT4046A demodulator power dissipation vs RS (typ.) (V<sub>CC</sub>=3 V; 4.5 V; 6 V).

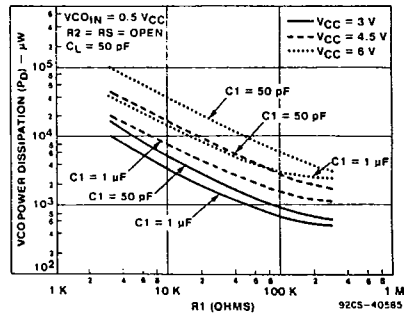

Fig. 41- HC4046A VCO power dissipation vs R1 (C1=50 pF; 1 μF).

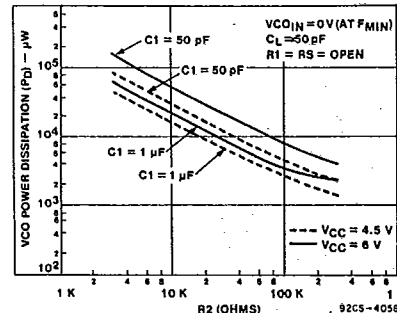

Fig. 42- HCT4046A VCO power dissipation vs R2 (C1=50 pF; 1 μF).

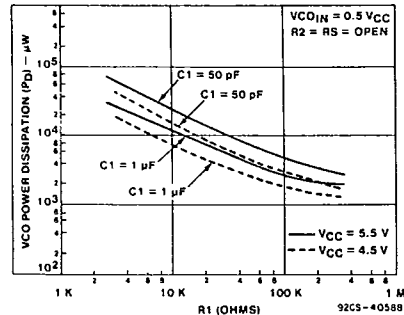

Fig. 43- HCT4046A VCO power dissipation vs R1 (C1=50 pF; 1 μF).

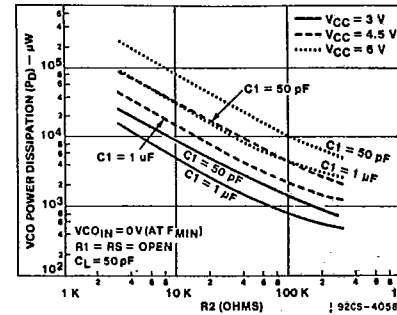

Fig. 44- HC4046A VCO power dissipation vs R2 (C1=50 pF; 1 μF).

HARRIS SEMICONDUCTOR 27E D 4302271 0017913 3 HAS

**CD54/74HC4046A**  
**CD54/74HCT4046A**

HC/HCT 4046A C<sub>PD</sub>

CHIP SECTION	HC	HCT	UNIT
COMPARATOR 1	48	50	pF
COMPARATORS 2 & 3	39	48	
VCO	61	53	

**APPLICATION INFORMATION**

This information is a guide for the approximation of values of external components to be used with the 74HC/HCT4046A in a phase-lock-loop system.

References should be made to Figs.10 through 14 as indicated in the table.

Values of the selected components should be within the following ranges.

- R1      between 3 kΩ and 300 kΩ;
- R2      between 3 kΩ and 300 kΩ;
- R1 + R2   parallel value > 2.7 kΩ;
- C1      greater than 40 pF.

SUBJECT	PHASE COMPARATOR	DESIGN CONSIDERATIONS
VCO frequency without extra offset	PC1, PC2 or PC3	<p><b>VCO Frequency characteristic</b></p> <p>With R2 = ∞ and R1 within the range 3 kΩ &lt; R1 &lt; 300 kΩ, the characteristics of the VCO operation will be as shown in Figs. 10-14. (Due to R1, C1 time constant a small offset remains when R2 = ∞)</p> <p><i>Fig. 45— Frequency characteristic of VCO operating without offset: f<sub>o</sub> = center frequency; 2f<sub>L</sub> = frequency lock range.</i></p>
	PC1	<p><b>Selection of R1 and C1</b></p> <p>Given f<sub>o</sub>, determine the values of R1 and C1 using Figs. 10-14.</p>
	PC2 or PC3	<p>Given f<sub>max</sub> and f<sub>o</sub>, determine the values of R1 and C1 using Fig. 30. Use Fig. 31 to obtain 2f<sub>L</sub> and then use this to calculate f<sub>min</sub>.</p>
VCO frequency with extra offset	PC1, PC2 or PC3	<p><b>VCO frequency characteristic</b></p> <p>With R1 and R2 within the ranges 3 kΩ &lt; R1 &lt; 300 kΩ, 3 kΩ &lt; R2 &lt; 300 kΩ, the characteristics of the VCO operation will be as shown in Figs. 26-29.</p> <p><i>Fig. 46— Frequency characteristic of VCO operating with offset: f<sub>o</sub> = center frequency; 2f<sub>L</sub> = frequency lock range.</i></p>

HARRIS SEMICONDUCTOR SECTOR 27E D 430227J 00179J4 5 HAS

CD54/74HC4046A  
CD54/74HCT4046A

T-50-17

APPLICATION INFORMATION (Cont'd.)

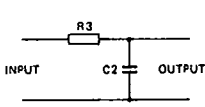
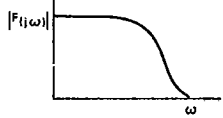
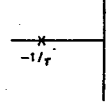
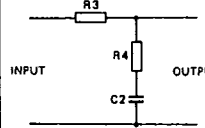
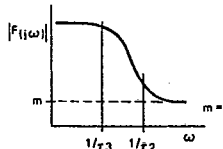
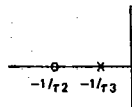
SUBJECT	PHASE COMPARATOR	DESIGN CONSIDERATIONS
VCO frequency with offset (continued)	PC1, PC2 or PC3	<p><b>Selection of R1, R2 and C1</b></p> <p>Given <math>f_o</math> and <math>f_L</math>, determine the value of product <math>R1C1</math> by using Figs. 26-29. Calculate <math>f_{off}</math> from equation <math>f_{off} = f_{CO} = f_L</math>. Obtain the values of <math>C1</math> and <math>R2</math> by using Figs. 26-29. Calculate the value of <math>R1</math> from the value of <math>C1</math> and the product <math>R1C1</math>.</p>
PLL conditions with no signal at the SIG <sub>IN</sub> input	PC1	VCO adjusts to $f_o$ with $\phi_{DEMODUT} = 90^\circ$ and $V_{VCOIN} = 1/2 V_{CC}$ (see Fig. 2).
	PC2	VCO adjusts to $f_o$ with $\phi_{DEMODUT} = -360^\circ$ and $V_{VCOIN} = 0$ V (see Fig. 4).
	PC3	VCO adjusts to $f_o$ with $\phi_{DEMODUT} = +360^\circ$ and $V_{VCOIN} = V_{CC}$ (see Fig. 6).
PLL Frequency capture range	PC1, PC2 or PC3	<p><b>Loop filter component selection</b></p>    <p>(a) <math>\tau = R3 \times C2</math>      (b) amplitude characteristic      (c) pole-zero diagram</p> <p>A small capture range (<math>2f_c</math>) is obtained if <math>\tau &gt; 2f_c^2 \approx 1/\pi (2\pi f_L/\tau)^{1/2}</math></p> <p><i>Fig. 47 — Simple loop filter for PLL without offset.</i></p>    <p>(a) <math>\tau_1 = R3 \times C2</math>;      (b) amplitude characteristic      (c) pole-zero diagram  <math>\tau_2 = R4 \times C2</math>;  <math>\tau_3 = (R3 + R4) \times C2</math></p> <p><i>Fig. 48 - Simple loop filter for PLL with offset.</i></p>

HARRIS SEMICONDUCTOR 27E D 4302271 0017915 7 HAS



**CD54/74HC4046A**  
**CD54/74HCT4046A**

HARRIS SEMICONDUCTOR

27E D 4302271 0017916 9 HAS

SUBJECT	PHASE COMPARATOR	DESIGN CONSIDERATIONS
PLL locks on harmonics at center frequency	PC1 or PC3	yes
	PC2	no
noise rejection at signal input	PC1	high
	PC2 or PC3	low
AC ripple content when PLL is locked	PC1	$f_r = 2f_i$ , large ripple content at $\phi_{\text{DEMOUT}} = 90^\circ$
	PC2	$f_r = f_i$ , small ripple content at $\phi_{\text{DEMOUT}} = 0^\circ$
	PC3	$f_r = f_{\text{SIG IN}}$ , large ripple content at $\phi_{\text{DEMOUT}} = 180^\circ$

